

*Fisher&Paykel*

## A HISTORY OF INNOVATION

Since our founding in 1934, we have grown into a global, design-led company of more than 3,000 people. Designed and engineered in New Zealand, our products are sold in 50 countries around the world. Our design heritage is founded on a pioneering spirit and a culture of curiosity that has challenged conventional appliance design to consistently deliver products tailored to human needs. For us, legacy is about looking into the future, while ensuring what we develop today is aligned to the fundamental principles of sustainable design. We are committed to ongoing research and development. Our culture is one of open innovation, which allows people to work collaboratively to find insights and ideas that connect with our customers and respect our planet.



We live one day at a time.











Cooking  
eating  
cleaning  
washing  
drying  
hunting  
gathering  
talking  
playing  
relaxing.







And then doing it all over again.

Day in, day out.







**TURNING ROUTINES INTO  
EXPERIENCES**

Behind every product is a story and that story starts with you. Your home is an expression of who you are and how you live. Our passion is creating better products that turn everyday routines into enjoyable experiences. We understand the dynamic nature of modern living. We deliver products that are adaptable, functional and durable, as well as human. We don't just make things that fit the space provided, we create products that fit the lives lived around them. Live life — we'll take care of the details.





## THE SOCIAL KITCHEN

The kitchen is the humble engine room in which we choose to live — where we create, socialise and enjoy the best that life has to offer. Cooking is a social activity. We generally place the key appliances in what we consider to be logical places: the work triangle of cooktop, sink and fridge. But we no longer cook in straight lines. We don't cook on conveyor belts. Sometimes we assemble, sometimes we bake, sometimes we stir-fry and sometimes we boil. We don't cook the same way every day: we can be a weekday cook and a weekend gourmet. The work triangle limits our creativity. It's not just about efficiency; sometimes it's about fun. Too many cooks may spoil the broth or they may create a wonderful, social and enjoyable meal. Let's reclaim the kitchen. Let's live outside the triangle.



#### DESIGNED FOR REAL LIFE

At Fisher & Paykel, we are curious about people—how they live, where they live, what they do and how they use things. This is where hidden insights wait to be uncovered. We are curious about not only the function and performance of our products, but also the emotional role they play in people's lives. For us, design is not a self-serving goal—it is a human endeavour to make life a little bit better.





COOK



## COOK TO CREATE

We see cooking not as a chore, but a creative act. As more of our lives become virtual and people look for ways to make and create things, we design high-performance tools you can rely on and be creative with, that turn everyday meals into creations. Fisher & Paykel products cater for different patterns of use—whether it's mid week convenience or weekend gourmet, heat and eat or a family feast. We understand everyday life and support the lives lived around our products. Cooking is part of our DNA—one part designer, one part chef. We have a passion for food and we are just as interested in making high-performance ovens that perfect your favourite foods as making the process of cooking more enjoyable. Our insights come from real-world use and then the results are tested in our lab daily, with the aim of inventing technologies that deliver the perfect cooking result.



### BUILT-IN OVENS

Fisher & Paykel's multifunction Built-in Ovens are designed to perfect your favourite food, with a full range of cooking modes and temperatures providing greater control and more flexibility; and with a selection of generous oven sizes to meet the needs of the most demanding cook. Roasting is an art as well as a science. The difference between rare and medium takes timing, intuition and a well-trained eye. Fisher & Paykel's Built-in Ovens are programmed to quickly heat to a high temperature, browning the meat to create delicious savoury flavours before automatically lowering the temperature to deliver a perfect, tender roast every time. Most of our ovens are pyrolytic self-cleaning and include cool-touch doors with multiple panes of glass and advanced cooling systems that ensure the external surfaces remain safe to the touch.



---

### 90cm Built-in Oven

---

A generous capacity and intuitive control system allows for precise cooking-mode selection every time. It's ideally suited to under-bench positioning and will align perfectly with other Fisher & Paykel 90cm Built-in appliances. This oven also features a pyrolytic self-cleaning function.

---

#### 1 Perfect Results

Create delicious savoury flavours, with the powerful 4050W professional quality rotisserie grill.

---

#### 2 Sized to Suit

With a spacious 103L total and 87L useable capacity, this wide oven is designed to accommodate both side-by-side and double-layered cooking.

---

#### 3 Designed to Match

Finished in black reflective glass and stainless steel, this elegant, yet durable design, sits beautifully within the Fisher & Paykel coordinated kitchen family.

---

#### 4 Easy Cleaning

No need for harsh chemical cleaners in our pyrolytic self-cleaning ovens; simply remove the racks and set to self-clean. Smoke and odours are minimised through a catalytic smoke eliminator.

---

#### 5 Precise Control

Oven functions are pre-set at the touch of a dial, while brilliant lighting, combined with a large viewing window reduce the need to open the oven door, improving energy efficiency and cooking results.

---

#### 6 Safe and Sound

Cool-touch doors save energy while keeping the kitchen cooler and safer for little hands. Telescopic slides make it easier and safer to remove hot dishes.

---

#### 7 Accessories

This oven comes with an easy-to-assemble rotisserie kit; a two-piece anti-splatter grill system and an aluminium baking tray.

---





### 60CM BUILT-IN OVEN

Welcome to the next generation in Fisher & Paykel Built-in Ovens. Designed specifically for diverse cooking styles, with generous capacity, high performance and a full range of oven functions including the new vent bake—which offers the ability to control the removal of moisture from the baking or roasting environment for optimum cooking results. An oven's performance can't be measured by a single stand-alone feature and our Built-in Ovens offer a full package of features and functions to deliver optimum results for both cooking and cleaning up afterwards. Built for cooking performance, an intuitive control system allows for precise cooking-mode selection every time. These ovens have generous internal capacity, fitting 30 percent more than traditional European ovens and they clean up after themselves with a pyrolytic self-cleaning function. The sleek lines and design detail mean they are ideally suited to fit with the rest of Fisher & Paykel's coordinated kitchen family, from Cooktops to ActiveSmart™ Fridges, DishDrawer™ Dishwashers and CoolDrawers™.

## 60cm Built-in Oven Range Features

### 1 ActiveVent™ System

Food is perfectly cooked with the lowest possible amount of energy using the ActiveVent™ system, unique to the 60cm Built-in Oven range. The active venting system and up to 11 cooking functions optimise the balance between excellent cooking performance, condensation management and energy consumption. Full temperature is reached quickly with a rapid heat-up feature and a powerful grill (up to 3200W) that gives you an even and quick result, perfect for browning and caramelising.



### 2 Large Oven

Sized to fit the food you cook, Fisher & Paykel have the largest 60cm Built-in Oven on the market, providing 90L total and 77L of usable capacity. The maximised height means you're able to fit a large casserole dish, the family roast and even a pie as well—true multi-shelf cooking. Two shelves can be fully utilised at the same time without hot spots or uneven browning. A 5.5kg turkey (or other cut of meat) can be deliciously cooked using the optional rotisserie kit (OB60SL11 & OB60SL9 models).



### 3 Elegant Design

All of the three models in our Built-in Oven range are finished in black reflective glass and stainless steel that blends elegant, minimalist aesthetic with design for durability. The finishes and handles match the rest of Fisher & Paykel's coordinated kitchen family, from Cooktops to ActiveSmart™ Fridges, CoolDrawers™ and DishDrawer™ Dishwashers.



### 4 Pyrolytic Self-Cleaning

No need for harsh chemical cleaners in our pyrolytic self-cleaning ovens as food residues inside the oven walls are naturally broken down at a very high temperature, leaving only a light ash that can be removed with a damp cloth. The non-pyrolytic OB60SL9 model has catalytic liners that break down oil and fat splashes during normal cooking. A unique clipping system for side racks and a simple glass mounting system for the oven door mean quick and easy removal and replacement when cleaning.



### 5 Pre-set Oven Functions

The range features three models with either 11, nine or seven cooking functions that include: Bake, Vent Bake, Fan Bake, Classic Bake, Pastry Bake, Fan Forced, Roast, Grill, Fan Grill, Rotisserie, Warm and Self-Clean. On the 11 and nine function models there is no need to program the functions, as these are pre-set at the touch of a dial to deliver just what you need to cook each dish to perfection.



### 6 Safety Features

The 60cm Built-in Oven features a beautifully balanced, lighter and less bulky cool-touch door for safety. An exceptional cooling system allows for a three-pane glass door rather than heavier four panes, while still achieving cool-touch status to ensure it's safe to touch externally. Sliding hot oven dishes all the way out of the oven is made safe with full extension shelves. These are designed to integrate with the shelf for quick and easy removal and adjustment.



### 7 Accessories

The rotisserie kit option has a 5.5kg capacity and ensures delicious roasts are browned evenly as the surface is continuously basted. Prepare the meat on the spit and rotisserie dish, then simply slide it into the oven. To achieve the perfect internal temperature, the meat probe will detect the temperature at the centre of the meat and show it on the control panel (OB60SL11 only). Crafted from heavy-gauge enamelled steel, the three-piece dish system includes a deep roasting dish, splatter tray and grill rack.







## 60cm Built-in Oven

Built for performance, an intuitive control system allows for precise cooking-mode selection. Generous internal capacity fits 30 percent more than traditional European ovens and offers a pyrolytic self-cleaning function\*. The sleek lines and design detail match the rest of the Fisher & Paykel built-in appliance range.

### 1 Perfect Results

Using the unique ActiveVent™ system and up to 11 cooking functions, you can optimise cooking performance, condensation management and energy consumption.

### 2 Sized to Suit

This is the largest 60cm Built-in Oven on the market, providing 90L total and 77L of usable capacity (OB60SL models only).

### 3 Designed to Match

Our Built-in Oven range is finished in black reflective glass and stainless steel, matching the rest of Fisher & Paykel's coordinated kitchen family.

### 4 Easy Cleaning

No need for harsh chemical cleaners in our pyrolytic self-cleaning ovens. The non-pyrolytic OB60SL9 model has catalytic liners that break down oil and fat splashes.

### 5 Precise Control

Oven functions are pre-set at the touch of a dial while brilliant lighting and a large viewing window reduce the need to open the oven door.

### 6 Safe and Sound

A clever cooling system allows for a lighter three-pane glass door, while still achieving cool-touch status.

### 7 Accessories

This oven comes with a heavy-gauge enamelled steel dish system with deep roasting dish, splatter tray and grill rack and the option of a rotisserie kit (OB60SL11 and OB60SL9 only) and meat probe (OB60SL11 only).

\* Pyrolytic function not available for OB60SL9 or OB60SL7 models



#### ACTIVE VENTING

An oven's performance can't be measured by temperature and heat alone — moisture is a vitally important but often neglected factor in the cooking performance of your oven. If your oven holds too much moisture or too little, your gastronomic creation can quickly turn to disaster. That's why the Fisher & Paykel nine and 11 function Built-in Ovens feature the unique ActiveVent™ system as well as a full package of features and functions (OB60SL11 only). Fisher & Paykel's ActiveVent™ system allows you to control the removal or retention of moisture from the baking or roasting environment to get the very best cooking results and energy consumption.



### KITCHEN COMPANION PRODUCTS

Whether it's a fresh coffee in the morning, a healthy steamed lunch or a quick ready-made meal in the evening, the Kitchen Companion Product Range takes convenience to a new level. The range includes a Coffee Maker, Steam Oven, Compact Oven, Combination Microwave Oven and Warming Drawer, offering a complete modular family designed to complement any kitchen. Temperature pre-selection and an oven programmer mean that cooking times can be pre-set across the product family, so multiple dishes can be easily coordinated. Each product is based on standard dimensions and can be easily configured to suit your preference — whether it's stacked vertically, placed side-by-side in a linear fashion or configured in a two-by-two block. Any combination will deliver a unified built-in solution. Design features include capacitive touch controls and standard fascia height with black reflective glass and polished metal trim matching the broader Fisher & Paykel range including Cooktops to ActiveSmart™ Fridges, CoolDrawers™ and DishDrawer™ Dishwashers to create an integrated look throughout your kitchen.



#### DESIGN FLEXIBILITY

Perfect modularity means Fisher & Paykel's kitchen companion products can be positioned for maximum functionality—whether this is in a compact block, a vertical stack or side-by-side in a linear set. Beautifully finessed design features matched with the optional trim kit allow the kitchen companion range to fit the popular 48cm kitchen module height.



---

## Compact Oven

---

Space — sometimes there just isn't enough of it. Enter the Fisher & Paykel Compact Oven, the little oven that thinks big, with design detail ideally suited to fit with other Fisher & Paykel's built-in appliances, both large and small.

---

### 1 Perfect Results

The Compact Oven delivers the superior performance and full functionality of a large model with a choice of eight multi-function programs, temperature pre-selection and an oven programmer.

---

### 2 Sized to Suit

A compact 460mm height means this oven can be placed virtually anywhere. All companion products can be installed at a convenient height to suit your kitchen design and preference.

---

### 3 Designed to Match

Finished in black reflective glass and polished metal, these elegant, yet durable compact ovens match the other companion products and the larger coordinated kitchen family.

---

### 4 Easy Cleaning

The Compact Oven has an easy-clean enamel interior with a catalysing filter that removes odours while you cook. The oven door has removable glass panes for effortless cleaning.

---

### 5 Precise Control

All the information you need at a glance is on the intuitive display, including a recipe menu and digital temperature control for absolute accuracy. Capacitive touch controls and an electronic touch panel make this oven very easy to use.

---

### 6 Safe and Sound

The compact oven has a well-balanced, three-pane glass, cool-touch oven door along with a childproof key lock for extra safety. Cool-touch doors save energy, keep the kitchen cooler and make the kitchen safer for little hands.

---





Fisher & Paykel

---

## Steam Oven

---

This Steam Oven provides appetising and healthier alternatives to fried and baked food. Steam cooking is one of the easiest yet oldest forms of cooking and can be used for almost any food. Heat from steam diffuses through food allowing it to cook in its own juices, retaining valuable nutrients, minerals and vitamins and—most importantly—flavour. The Steam Oven adds a new dimension to oven-based cooking.

---

### 1 Perfect Results

---

The Fisher & Paykel Steam Oven allows for healthy and easy cooking—keeping food moist and fresh with no oil, smoke or mess. The oven heats up quickly and cooks most meals in 30 minutes or less.

---

### 2 Sized to Suit

---

At 460mm high, this 29L built-in Steam Oven can be placed virtually anywhere, fitting perfectly with other products in the kitchen companion range. An optional 21mm trim kit ensures a perfect match with the full range of 60cm built-in kitchen products.

---

### 3 Designed to Match

---

All of our kitchen companion products are finished in black reflective glass with polished metal trim that blends elegance with durability.

---

### 4 Easy Cleaning

---

Cleaning and care of the Steam Oven is simple. After each use, simply clean the smooth stainless steel interior with a dry cloth after the steam generator has cooled.

---

### 5 Precise Control

---

The oven beeps when the food is ready and the intuitive display provides all the information you need, including cooking function selection, time and when to refill. A removable one litre water reservoir is used to generate steam that lasts almost an hour. An alarm sounds when it's empty and it's simple to refill.

---

### 6 Safe and Sound

---

The Steam Oven comes with a childproof key lock for extra safety.

---

---

## Combination Microwave Oven

---

Fast cooking is the primary advantage of the built-in Combination Microwave Oven. This oven merges the traditional crisping and browning benefits of the convection oven with the speed of a microwave, and 10 different cooking modes including Reheat, Defrost, Bake and Grill.

---

### 1 Perfect Results

Forget soggy defrosted foods or uneven heating. This oven incorporates the best of convection and microwave technology and eliminates the need for two separate appliances, with a choice of 10 cooking modes combined with a powerful 1000W microwave offering 19 power levels.

---

### 2 Sized to Suit

A compact 460mm height means this Combination Microwave Oven can be placed virtually anywhere at a height to suit you. An optional 21mm trim kit ensures a perfect match with the full range of 60cm built-in kitchen products.

---

### 3 Designed to Match

All of our kitchen companion products are finished in black reflective glass and polished metal that blend an elegant, minimalist aesthetic with design for durability.

---

### 4 Easy Cleaning

The smooth enamel interior with glass inner door, drop-down grill and removable side racks, along with a turntable, make cleaning easy.

---

### 5 Precise Control

All the information you need at a glance is shown on the intuitive display, including a cooking guide with 12 pre-selected automatic cooking modes.

---

### 6 Safe and Sound

The Combination Microwave Oven has a childproof key lock for extra safety.

---



Fisher & Paykel



Fisher & Paykel

---

## Coffee Maker

---

Like having a barista in your kitchen, the built-in Coffee Maker is designed to make coffee just the way you like it. Offering adjustable coffee strength and temperature, multiple coffee cup sizes and 15-bar pressure at the touch of a button, it's the perfect way to start each day.

---

### 1 Perfect Results

---

Easily adjusted to suit your preference, this Coffee Maker also provides automatic descaling and cleaning for perfect coffee, every time.

---

### 2 Sized to Suit

---

The adjustable coffee dispenser holds 250g of coffee and the centrally positioned steam milk frother avoids unnecessary detachable milk containers.

---

### 3 Designed to Match

---

Finished in black reflective glass and polished metal, the Coffee Maker matches the other Fisher & Paykel coordinated kitchen family.

---

### 4 Easy Cleaning

---

The Coffee Maker has a self-cleaning function and comes with a removable drip tray and a bin for used coffee grounds.

---

### 5 Precise Control

---

The intuitive electronic touch panel display includes refill, cleaning and maintenance data, plus a program to memorise your favourite coffee recipe. Twin LED lights ensure you see what you are doing on those dark mornings.

---

### 6 Safe and Sound

---

The unit glides out on telescopic slides to easily add coffee beans and the adjustable shut-off timer switches the machine off after a set period or when you have made your last coffee. The on/off switch is conveniently hidden for children's safety.

---

### 7 Accessories

---

These comprise: coffee dispenser spoon; descaling solution; and optional lower trim kit.

---





---

## Warming Drawer

---

Putting the finishing touch to a delicious meal or coffee, the Warming Drawer keeps plates and cups warm. It's designed to fit under 48cm or 60cm high appliances and can be installed in many combinations—under the bench or built into the wall. It's also strong enough to support the weight of other products such as an oven or coffee maker.

---

### 1 Perfect Results

---

A separate Warming Drawer allows you to warm plates while you finish cooking. The temperature control settings (45°, 55° and 65°C) and even heat distribution within the Warming Drawer means no hot spots. Two timer settings can maintain a temperature for a set time or it can be left on for up to 12 hours.

---

### 2 Sized to Suit

---

Designed to fit under 48cm and 60cm ovens and other kitchen appliances, the Warming Drawer can be installed with or without other appliances under-bench or built into the wall at a convenient height.

---

### 3 Designed to Match

---

Finished in black reflective glass or stainless steel, the Warming Drawer matches the other Fisher & Paykel kitchen companion products and the larger coordinated kitchen family.

---

### 4 Easy Cleaning

---

The front panel and smooth-glass base of the Warming Drawer are easy to wipe clean.

---

### 5 Precise Control

---

All the information you need at a glance is shown on the illuminated touch display, including temperature settings and shut-off timer.

---

### 6 Safe and Sound

---

Full extension slides make it safe to remove hot crockery with minimal obstructions and, as an extra safety measure, the drawer turns itself off after 12 hours of continuous use.

---





## COOKTOPS

So many things to consider when selecting a cooktop: a look to match your kitchen, a size to fit your space and a fuel type to suit your cooking style. It all comes down to personality and preference. Whether it's the performance and theatre of live flame, the precision, control and sleek simplicity of induction, or the straightforward power of an electric cooktop, Fisher & Paykel's Cooktop family is designed to provide a full range of solutions. Whatever your choice, there are many configurations and sizes to suit any cooking style. Each product has been designed to deliver great performance—from searing heat to the gentlest of simmers—and all are designed for easy cleaning and with safety in mind.

---

## Gas on Glass Cooktops

---

The Gas on Glass range combines the cleanability of the highest-quality glass surface with the efficiency of gas cooking. It delivers total cooking precision through the latest burner technology and elegant stainless steel controls. The Gas on Glass series is a modular family of appliances designed using premium quality materials with a polished metal trim.

---

### 1 Perfect Results

Our award-winning Gas on Glass Cooktops come equipped with powerful burners; the wok burner has a uniform flame for even heat distribution while the auxiliary burner has the added capability of exceptionally low temperatures (0.7MJ/h)—ideal for delicate sauces.

---

### 2 Sized to Suit

A range of different sized elements can be used together: 90cm three-burner and 75cm two-burner. The wok burner comfortably takes a large wok and is among the most powerful on the market at 18MJ/h.

---

### 3 Designed to Match

The black reflective glass, brushed stainless steel and polished metal trim blend elegance with durability to match the rest of our coordinated kitchen family.

---

### 4 Easy Cleaning

The easy-to-clean cooktop design means you can simply remove the trivets, wipe and walk away.

---

### 5 Precise Control

It delivers total cooking precision through the latest burner technology and elegant stainless steel controls.

---

### 6 Safe and Sound

The flame failure safety device means that if the flame is accidentally extinguished the gas automatically turns off. We only use ecofriendly ceramic glass without any arsenic or heavy metals used in the manufacturing process.

---

Red Dot Award 2013—Product Design







---

## Gas on Steel Cooktops

---

The Gas on Steel cooktops come in different sizes and offer power levels for everything from a slow simmer for sauces, to an intense heat for steaks and stir-fries. Combining the attractiveness of sleek stainless steel with the durability of cast iron trivets, these cooktop supports the most avid chef.

---

### 1 Perfect Results

---

The Gas on Steel Cooktop perfects the slow simmer for sauces to the intense heat needed for steaks and stir-fries, with five different strength burners including some of the most powerful available.

---

### 2 Sized to Suit

---

With up to five burners, including simmer, rapid and two wok burners provide great cooking flexibility.

---

### 3 Designed to Match

---

The brushed stainless steel blends elegance with durability — matching the rest of our coordinated kitchen family.

---

### 4 Easy Cleaning

---

These cooktops are designed as a singular piece of steel with quick component removal for easy cleaning. Durable and easy to clean, cast iron box trivets provide a safe and stable cooking surface. The rubber feet ensure that the cooktop is not scratched when the trivets are placed onto the cooktop.

---

### 5 Precise Control

---

Innovalve™ technology allows you to adjust the flame with unprecedented 180 degree gas valve rotation (CG905DWACX1 only). Most cooktops offer only 70 degree rotation. For accurate temperature control, ergonomic dials on the side of the cooktop automatically ignite the flame quickly and safely.

---

### 6 Safe and Sound

---

Indicator lights show which burners are in use and alert you if the gas shuts down (CG905DWACX1 only). The flame failure safety device means that if the flame is accidentally extinguished the gas automatically turns off. All Fisher & Paykel Gas Cooktops feature electronic ignition ensuring they are quick, reliable and safe.

---



---

## Touch Control Induction Cooktops

---

Traditionally we cook by generating heat from one source, such as a flame, and conducting it to another. Fisher & Paykel Induction Cooktops work on a different principle. The cooktop itself produces electromagnetic vibrations, which induce the pot or pan to generate its own heat, resulting in shorter heat-up times and a safer cooking surface.

---

### 1 Perfect Results

---

The PowerBoost function delivers instant, intense heat when you need it and the GentleHeat function produces slow, continuous simmering.

---

### 2 Sized to Suit

---

Select from 90cm five zone; 75cm four zone; and 60cm four zone; to suit all sizes of cookware. The cooktops are perfectly flat so the surface can be used as an extension of your preparation area.

---

### 3 Designed to Match

---

Induction cooking is popular with those who love visual simplicity and clean, smooth lines. Finished in black glass, you get elegant design with durability.

---

### 4 Easy Cleaning

---

The flat surface is easy to clean because there are no obstructions and because Induction heats just the pot rather than the surrounding glass, the likelihood of burned spill overs is greatly reduced.

---

### 5 Precise Control

---

Induction cooking delivers an immediate response with greater energy efficiency than that of either gas or electric. Soft-touch controls are simple to use and provide great precision.

---

### 6 Safe and Sound

---

This cooktop will alert you if it's turned on without a pot or pan on it, and will switch off if you don't respond. It will switch off if the pan being used isn't suitable for induction cooking and a key lock is provided for extra safety. We use ecofriendly ceramic glass in the production of our Induction Cooktops without any arsenic or heavy metals used in the manufacturing process.

---



---

## Electric Cooktops

---

### 1 Perfect Results

Solid performers with superb simmer results, our Electric Cooktops allow you to move pots and pans around simply and quickly while high-speed ribbon elements provide good temperature control from a rapid boil to an extremely low simmer.

### 2 Sized to Suit

Four size variations and either two, four or five element configurations are available. Because our Electric Cooktops are perfectly flat and cool down quickly when switched off, the surface can be used as an extra preparation area.

### 3 Designed to Match

Designed using premium quality materials, the finishes and controls match the rest of our coordinated kitchen family.

### 4 Easy Cleaning

The flat surface makes our Electric Cooktops very easy to clean. Ceramic glass is very strong, adding to the durability and performance of the cooktop.

### 5 Precise Control

You have the choice of classic dial controls or the perfectly flat Touch&Slide functionality. The intelligent timer on touch-control models lets you activate any combination of elements, or you can simply use it as a minute minder.

### 6 Safe and Sound

Hot surface indicators glow until the surface is safe to touch and the Touch&Slide Electric Cooktop will turn off if something spills over the controls. We use eco-friendly ceramic glass in our Cooktops, without any arsenic or heavy metals used in the manufacturing process.

---





## FREESTANDING COOKERS

Fisher & Paykel's Freestanding Cookers are the showpiece of the kitchen and deliver outstanding performance. These are the domestic version of the professional chef's cooker. With a commanding presence they not only look like they've come from a restaurant kitchen but also deliver similarly high performance. There are up to eight cooking functions in the electronic oven ranging from Defrost to Fan Bake including Rotisserie in some models and a powerful grill element – perfect for any culinary requirements.



---

## 90cm Freestanding Cooker — Gas

---

This freestanding, professional-style cooker gives you the flexibility to prepare several courses simultaneously. With a large electric oven combined with a five-burner gas cooktop, the clean lines in black reflective glass and stainless steel complement the style and elegance of any kitchen.

---

### 1 Perfect Results

---

Eight oven functions from Fan Grill to traditional Bake and Rotisserie, plus a powerful 3600W grill, give you professional quality results.

---

### 2 Sized to Suit

---

Our Freestanding Cookers are spacious, with a 103L total and 87L usable capacity. A shelving system and concealed lower element allow ample space for larger meals.

---

### 3 Designed to Match

---

Designed using premium quality materials and built to last, the black reflective glass and stainless steel blend balanced aesthetic with design for durability.

---

### 4 Easy Cleaning

---

Concealed elements and a drop-down grill make cleaning quick and simple, while catalytic liners break down oil and fat splashes during normal cooking. The cooktop is made from a single piece of stainless steel that contains spills. The oven door and its inner pane of glass can be removed for easy cleaning and the storage compartment minimises clutter for all oven accessories.

---

### 5 Precise Control

---

Generous metal control dials with a simple, functional interface are positioned on a full stainless steel control panel for precise control over cooking temperatures.

---

### 6 Safe and Sound

---

A cool-touch door and built-in cooling system ensure the oven door is safe to touch externally. Streamlined trivets let you slide pots and pans without lifting them.

---





## RANGEHOODS

Kitchen inspiration doesn't exist in a vacuum, but simple and responsive extraction is as important as achieving the right look for your kitchen. Designed to complete your kitchen, you can select a Rangehood that sits above your cooktop or one that is hidden away until needed, depending on what best suits your kitchen layout and cooking style. No matter which you choose, all of Fisher & Paykel's ventilation products are built to perform. Whether it is a built-in Powerpack, or Canopy-style VentSurface™, each has been designed as the perfect partner to our Cooktops and each captures and eliminates cooking odours, vapour and steam effectively. They are easy to use and feature intuitive controls that respond to the touch of a finger.



---

## VentSurface™ Wall Rangehoods

---

VentSurface™ has been designed to provide a simple and efficient means of removing steam and cooking odours from the kitchen through automatic adjustment.

---

### 1 Effective and Quiet

---

The clever technology in this Rangehood senses cooking activity and turns on automatically and constantly adjusts to capture and eliminate rising cooking odours, vapour or steam. Perimeter extraction technology creates a high velocity vacuum that is more effective over a wider area than that of traditional Rangehoods and is far quieter than those using conventional technology.

---

### 2 Designed to Match

---

VentSurface™ comes in two sizes (120cm and 90cm) and is designed to fit any contemporary kitchen and match the Fisher & Paykel kitchen family. VentSurface™ Rangehoods are finished in black reflective glass and stainless steel that blend elegance with durability, while hiding unsightly filters.

---

### 3 Easy Cleaning

---

The black reflective glass and stainless steel finishes are easily wiped clean and the filters are dishwasher safe. A filter cleaning alert reminds you when to clean it and ensures you get the best performance out of the Rangehood.

---

### 4 Precise Control

---

A small selection of simple, soft-touch buttons give you control of the clever technology inside and once set to automatic, the VentSurface™ responds the moment you start cooking.

---



---

## Canopy Rangehood

---

Designed as the perfect partner to our Cooktops, Canopy Rangehoods are easy to use, easy to clean and feature intuitive controls.

---

### 1 Effective and Quiet

---

These Rangehoods offer a selection of fan speeds and clever features that quietly and efficiently remove steam and cooking odours from the kitchen. Odours can linger in the kitchen well after cooking is finished. The practical timer feature keeps the canopy working for up to 15 minutes before it automatically turns itself off.

---

### 2 Designed to Match

---

Fisher & Paykel's Canopy Rangehoods will fit any contemporary kitchen and perfectly match the Fisher & Paykel kitchen family with their black reflective glass and stainless steel.

---

### 3 Easy Cleaning

---

An interior, wipeable plate makes cleaning effortless. Multi-layered filters trap grease effectively. Designed for simple removal, the filters are easy to clean and dishwasher safe.

---

### 4 Precise Control

---

The sleek touch-control panel responds to the touch of your finger. Halogen lights provide superb illumination over the entire cooking surface. The dimmable light feature enables you to create the perfect level of light. (HC12DCXB1, HC90DCXB1 only).

---



Built-in 90cm Oven



01

①  
**OB90S9MEPX2**  
90cm Single Pyrolytic  
Built-in Oven  
H478 x W895 x D566mm

Built-in 60cm Ovens



01



02

②  
**OB60SL11DEPX1**  
60cm 11 Function Pyrolytic  
Built-in Oven  
H598 x W596 x D580mm

③  
**OB60SL9DEX1**  
60cm Nine Function  
Built-in Oven  
H598 x W596 x D580mm

④  
**OB60SL7DEX1**  
60cm Seven Function  
Built-in Oven  
H598 x W596 x D580mm

⑤  
**OB60SL7DEW1**  
60cm Seven Function  
Built-in Oven  
H598 x W596 x D580mm



03



04

Built-in 60cm Ovens  
Cont.



05



06



07

⑥  
**OB60B77DEX3**  
60cm Double Built-in Oven  
H888 x W595 x D567mm

⑦  
**OB60SCMX4**  
60cm Single Built-in Oven  
H597 x W595 x D567mm

⑧  
**OB60NDEX2**  
60cm Compact Built-in Oven  
H450 x W595 x D556mm

Kitchen Companion  
Products



01



02



03



04



05



06

⑨  
**OB60N8DTX1**  
60cm Built-in Conventional  
Compact Oven  
H457 x W595 x D570mm

⑩  
**OS60NDTX1**  
60cm Built-in Steam Oven  
H457 x W595 x D423mm

⑪  
**OM36NDXB1**  
60cm Built-in Combination  
Microwave Oven  
H457 x W595 x D570mm

⑫  
**EB60DSXB1**  
60cm Built-in Coffee Maker  
H457 x W595 x D412mm

⑬  
**WB60SDEB1**  
60cm Warming Drawer  
H118 x W596 x D555mm

⑭  
**WB60SDEX1**  
60cm Warming Drawer  
H118 x W596 x D555mm

Gas on Steel Cooktops



01



02



03



04



05

④  
**CG905DWACX1**  
90cm 5 Burner Gas Cooktop  
H76 x W914 x D546mm

④  
**CG905DX1**  
90cm 5 Burner Gas Cooktop  
H64 x W900 x D530mm

④  
**CG905DWFCX1**  
90cm 5 Burner Gas Cooktop  
H50 x W914 x D533mm

④  
**CG604DX1**  
60cm 4 Burner Gas Cooktop  
H64 x W600 x D530mm

④  
**CG604DWFCX1**  
60cm 4 Burner Gas Cooktop  
H50 x W578 x D511mm

Gas on Glass Cooktops



01



02

④  
**CG903DNGB1 (natural gas)**  
**CG903DLPGB1 (LPG)**  
90cm 3 Burner Gas Cooktop  
H59 x W900 x D450mm

④  
**CG752DNGB1 (natural gas)**  
**CG752DLPGB1 (LPG)**  
75cm 2 Burner Gas Cooktop  
H59 x W750 x D450mm

Induction Cooktops



01



02



03

④  
**C1905DTB1**  
90cm 5 Zone Induction Cooktop  
H50 x W900 x D530mm

④  
**C1754DTB1**  
75cm 4 Zone Induction Cooktop  
H50 x W750 x D530mm

④  
**C1604DTB1**  
60cm 4 Zone Induction Cooktop  
H50 x W600 x D530mm

Electric Cooktops



01



02



03



04



05

01  
**CE754DTB1**  
75cm 4 Element Electric Cooktop  
H58 x W750 x D530mm

02  
**CE604DTB1**  
60cm 4 Element Electric Cooktop  
H58 x W600 x D530mm

03  
**CE905CBX1**  
90cm 5 Element Electric Cooktop  
H59 x W900 x D530mm

04  
**CE604CBX1**  
60cm 4 Element Electric Cooktop  
H59 x W600 x D530mm

05  
**CE302CBX1**  
30cm 2 Element Electric Cooktop  
H63 x W300 x D530mm

Freestanding Cookers



01



02



03

01  
**OR120DDWGF2**  
120cm Freestanding Cooker  
H915—927 x W1195 x D600mm

02  
**OR90SDBGFX2**  
90cm Freestanding Cooker  
H892—917 x W898 x D600mm

03  
**OR90SDBSX2**  
90cm Freestanding Cooker  
H892—917 x W898 x D600mm

**VentSurface™  
Rangehoods**



①  
**HI120MXB1**  
120cm VentSurface™  
Island Rangehood  
H682 – 939 x W1198 x D648mm

②  
**HC90MXB1**  
90cm VentSurface™  
Wall Rangehood  
H682 – 939 x W898 x D470mm



**Canopy Rangehoods**



①  
**HC120DCXB1**  
120cm Wall Canopy Rangehood  
H635 – 1035 x W1200 x D500mm

②  
**HC90DCXB1**  
90cm Wall Canopy Rangehood  
H635 – 1035 x W900 x D500mm

③  
**HC60DCXB1**  
60cm Wall Canopy Rangehood  
H635 – 1035 x W600 x D500mm





**Canopy Rangehoods  
Cont.**



04

④  
**HC90PCHTX2**  
**90cm Wall Canopy Rangehood**  
H648—1068 x W900 x D480mm

⑤  
**HC60PCHTX2**  
**60cm Wall Canopy Rangehood**  
H648—1068 x W600 x D450mm



05

**Splashback**



01

①  
**SB90X3**  
**90cm Splashback**  
H750 x W900 x D10mm

C

O

O

L



## WE CONTROL THE WEATHER

At the heart of Fisher & Paykel's Fridge-Freezers is the ability to sense and respond to daily use in an intelligent way. The combination of temperature sensors with smart electronics and variable-speed fans creates a controlled environment and optimum temperature for better food care. We call it ActiveSmart™ technology. Your fridge door is the most used door in your home and, every time it is opened, the temperature changes around your food. The challenge is maintaining a consistent and controlled environment despite ongoing changes inside and outside the fridge. ActiveSmart™ achieves this through constantly monitoring how you and your family use your fridge, adjusting airflow to maintain a stable and even temperature. So despite highs, lows and occasional gusty winds, when it comes to your fridge, let ActiveSmart™ control the weather to deliver better food care.



ACTIVESMART™  
TECHNOLOGY



---

### 90cm CoolDrawer™

---

The CoolDrawer™ has been designed to change from refrigerator to freezer at the touch of a button. It is built on the concept of distributed refrigeration, combining ActiveSmart™ technology with a drawer-based design that can be placed anywhere in the kitchen, home or entertainment area. The CoolDrawer™ provides five temperature settings to deliver total flexibility – freezer, chill, fridge, pantry and wine modes, merging intelligence with convenience.

---

#### 1 Innovative

---

The multi-temperature CoolDrawer™ is a world-first in refrigeration technology.

---

#### 2 Convenient

---

Five temperature settings can be tailored to the needs of your food: freezer, chill, fridge, pantry and wine mode, combining intelligence with convenience.

---

#### 3 Ergonomic

---

There is easy access at waist height, with smooth-running drawers.

---

#### 4 Intuitive

---

The easy-to-use electronic interface can change the CoolDrawer™ temperature at the touch of a button.

---

#### 5 Flexible

---

This innovation complements your existing refrigeration and enhances your kitchen design to suit your lifestyle.

---

#### 6 Precise

---

Highly engineered finishing ensures a 4mm clearance between front panels, as demanded by professional cabinetmakers.

---





---

## CoolDrawer™ Range Features

---

---

### 1 Freezer Mode

---

This mode is ideal for general frozen food storage with the added flexibility of three freezer functions—bottle chill, fast freeze and deep freeze. Freezer Mode is set at  $-18^{\circ}\text{C}$  for longer-term storage of frozen items.



---

### 2 Chill Mode

---

Chill Mode sets the compartment to a temperature perfect for highly perishable meats, poultry and seafood. For these types of food it is ideal to store them at a temperature as close to freezing as possible to retain their vital freshness. Chill Mode sets the compartment at  $-0.5^{\circ}\text{C}$ , just above the freezing temperature for meat.



---

### 3 Fridge Mode

---

This mode provides the ideal storage for most foods requiring normal refrigeration, such as fruit and vegetables, dairy products, processed meats and drinks. The compact upper storage tray is a perfect place for sensitive foods such as peaches, cherries, cheeses and deli items; the tall bin is ideal for large bottles and containers.



---

### 4 Pantry Mode

---

This is designed for foods that require a cool, dark place for storage, such as tropical fruits, tomatoes, bananas, bread and cereals. Pantry Mode provides a solution for all those foods that you didn't previously know what to do with and have always resorted to storing on the bench or in the cupboard. This setting offers a stable storage environment at  $12^{\circ}\text{C}$ , making it ideal for sensitive foods.



---

### 5 Wine Mode

---

Using the innovative Wine Mode, connoisseurs can take advantage of special settings that preserve and present wine at its optimum temperature. This mode is ideal for long-term storage of all wine at  $12^{\circ}\text{C}$  and offers two temperature selections for short-term storage.





---

## French Door Refrigerators

---

This range has been designed to maximise space as well as access. French Door refrigerators bring theatre into the kitchen with unobstructed access to wide-open shelf spaces. Below, a spacious full-extension drawer and storage bins provide ergonomic solutions for freezer items.

---

### 1 Ice & Water

---

Ice & Water models deliver chilled, filtered water automatically. The slimline touch pad and angled water delivery mean that almost any size or shape of vessel can be filled. The icemaker automatically delivers ice into a dedicated bin and can be easily customised to store different volumes.

---

### 2 Humidity Control System

---

The Humidity Control System, together with the cool and consistent temperature delivered by ActiveSmart™ technology, creates the perfect microclimate in each produce bin. Two humidity control slides offer settings for both fruit and vegetables to retain optimal moisture and freshness.

---

### 3 Ergonomic

---

Uninterrupted wide-open spaces and numerous shelving options enable easy customisation for different uses. Quality extension runners allow you to slide out storage bins and trays fully for easy loading and unloading. The storage bins are removable, making food preparation and cleaning easier.

---

### 4 Efficient

---

Alarms on the refrigerator and freezer alert you if the door has been left open. Adaptive defrost means that there is no need for 'holiday mode' settings. The ActiveSmart™ will select the best time to defrost based on how the appliance is being used. When you are away, it will recognise lower levels of use and defrost less often, therefore using less energy.

---

### 5 Safe

---

Secure glass shelving contains drips and spills and prevents them from falling on items stored below.

---

Available in August 2013



---

## Bottom Freezer Refrigerators

---

The 790mm Door Drawer has been designed for what you use most often. The refrigerator enables easy access to everyday items. It includes ergonomic storage bins and glass shelves that can be configured to suit every lifestyle. The lower drawer-based freezer shelves ensure that long-term storage items are just as easy to access. Available as a standard door and drawer format.

---

### 1 Ice & Water

Ice & Water models deliver chilled, filtered water automatically. The slimline touch pad and angled water delivery mean that almost any size or shape of vessel can be filled. The icemaker automatically delivers ice into a dedicated bin and can be easily customised to store different volumes.

---

### 2 Humidity Control System

Fruit and vegetable quality can be maintained at the right humidity and temperature level. The Humidity Control System, together with the cool and consistent temperature delivered by ActiveSmart™ technology, creates the perfect microclimate in each produce bin. Two humidity control slides offer settings for both fruit and vegetables to retain optimal moisture and freshness.

---

### 3 Ergonomic

Uninterrupted wide-open spaces and numerous shelving options enable easy customisation for different uses. Quality extension runners allow you to slide out storage bins and trays fully for easy loading and unloading. The storage bins are removable, making food preparation and cleaning easier. Some models also feature a drawer freezer for ease of use.

---

### 4 Efficient

Alarms on the refrigerator and freezer alert you if the door has been left open. Adaptive defrost means that there is no need for 'holiday mode' settings. The microprocessor will select the best time to defrost based on how the appliance is being used. When you are away, it will recognise lower levels of use and defrost less often, therefore using less energy.

---

### 5 Safe

Secure glass shelving contains drips and spills and prevents them from falling on items stored below.

---

Available in August 2013





### **SURROUND KIT**

The refrigeration Surround Kit helps create a seamless connection between your appliance and its surrounding cabinetry. Available in a stainless steel finish, the kit frames and complements the product. A Joiner Kit can also be used to join two refrigerators. For more information visit [fisherpaykel.asia](http://fisherpaykel.asia) or [fisherpaykel.in](http://fisherpaykel.in)



---

## ActiveSmart™ Range Features

---

---

### 1 Humidity Control System

---

The Humidity Control System, together with the cool and consistent temperature delivered by ActiveSmart™ technology, creates the perfect microclimate in each produce bin. The humidity control lid protects fresh produce from drier refrigerator air, keeping fruit and vegetables fresher for longer. The lid traps the excess water vapour produced and channels it away for evaporation. Two humidity control slides offer settings for both fruit and vegetables, ensuring optimal moisture and freshness is retained.



---

### 2 Variable-speed Fans

---

Independent variable-speed fans control airflow through multiple air ducts in the refrigerator and freezer. This means greater control when new items are introduced to either compartment as well as rapid chill and freezing to ensure food safety and maintain food quality.



---

### 3 Temperature and Door Sensors

---

Sensors constantly record changes to fridge and freezer compartments, including when the doors are opened and when new items are introduced. This information is continuously communicated to the microprocessor which, in conjunction with the variable-speed fans and air ducts, ensures that the temperature in each compartment is kept constant. All ActiveSmart™ fridges can be placed into Sabbath mode.



---

### 4 Adaptive Defrost

---

Alarms on the refrigerator and freezer alert you if the door has been left open. Adaptive defrost means that there is no need for 'holiday mode' settings. The microprocessor will select the best time to defrost based on how the appliance is being used. When you are away, it will recognise lower levels of use and defrost less often, therefore using less energy.



---

### 5 Filtered Ice & Water

---

Unique Ice & Water models have fully integrated in-door water dispensing and internal icemaking that do not use any space in your refrigerator, providing maximum food storage. The slimline touch pad and angled water delivery means almost any size or shape of vessel can be filled with chilled, filtered water. The internal icemaker is housed above the freezer and can fill various-sized bins for customised ice storage.



---

### 6 Ergonomic Design

---

Uninterrupted wide-open spaces and numerous shelving options enable easy customisation for different uses. Secure glass shelving contains drips and spills and prevents them from falling on items stored below. Quality extension runners allow you to slide out storage bins and trays fully for easy loading and unloading. The storage bins are removable, making food preparation and cleaning easier.



CoolDrawer™



01

Ⓜ  
**RB90S64MKIW1**  
**90cm CoolDrawer™**  
 H640 x W855 x D557mm  
 (Excluding drawer panel, including power cord)

**Optional Stainless Steel Pre-finished Door**  
 H476 x W896 x D18mm

Integrated Bottom Freezer Refrigerator



01

Ⓜ  
**RB60V18**  
**60cm Integrated Bottom Freezer Refrigerator**  
 H1773 x W540 x D544mm  
 Apply your own cabinetry façade and handle— not included

Ice & Water French Door Refrigerators



01

Ⓜ  
**RF610ADUSX4**  
**French Door Refrigerator**  
 H1790 x W900 x D695mm  
 (Dimensions excluding handles)  
 Flat door

Ice & Water French Door Refrigerators Cont.



02

Ⓜ  
**RF522ADUSX4**  
**French Door Refrigerator**  
 H1715 x W790 x D695mm  
 (Dimensions excluding handles)  
 Flat door

French Door Refrigerator



01

Ⓜ  
**RF522ADX4**  
**790mm French Door Refrigerator**  
 H1715 x W790 x D695mm  
 (Dimensions excluding handles)  
 Flat door

Ice & Water Bottom Freezer Refrigerators



01

Ⓜ  
**RF522WDRXU4,**  
**RF522WDLXU4**  
**Door Drawer Refrigerator**  
 H1715 x W790 x D695mm  
 (Dimensions excluding handles)  
 Flat door

**Ice & Water  
Bottom Freezer  
Refrigerators Cont.**



02

Ⓜ  
**E442BRXFDU4**  
**Bottom Freezer Refrigerator**  
H1715 x W680 x D695mm  
(Dimensions excluding handles)  
Flat door

Ⓜ  
**E402BRXFDU4**  
**Bottom Freezer Refrigerator**  
H1715 x W635 x D695mm  
(Dimensions excluding handles)  
Flat door



03

**Bottom Freezer  
Refrigerators**



01

Ⓜ  
**RF522WDRX4,  
RF522WDLX4**  
**Door Drawer Refrigerator**  
H1715 x W790 x D695mm  
(Dimensions excluding handles)  
Flat door

**Bottom Freezer  
Refrigerators Cont.**



02

Ⓜ  
**E402BRXFD4**  
**Bottom Freezer Refrigerator**  
H1715 x W635 x D695mm  
(Dimensions excluding handles)  
Flat door

Ⓜ  
**E522BRX4,  
E522BLX4**  
**Bottom Freezer Refrigerator**  
H1695 x W790 x D715mm  
(Dimensions excluding handles)  
Curved door

Ⓜ  
**E442BRX4,  
E442BLX4**  
**Bottom Freezer Refrigerator**  
H1695 x W680 x D715mm  
(Dimensions excluding handles)  
Curved door



03



04



**Bottom Freezer Refrigerators Cont.**



05

Ⓜ  
**E402BRX4**  
**Bottom Freezer Refrigerator**  
 H1695 x W635 x D715mm  
 (Dimensions excluding handles)  
 Curved door

Ⓜ  
**E522BRE4,**  
**E522BLE4**  
**Bottom Freezer Refrigerator**  
 H1695 x W790 x D715mm  
 (Dimensions excluding handles)  
 Curved door

Ⓜ  
**E402BRE4**  
**Bottom Freezer Refrigerator**  
 H1695 x W635 x D715mm  
 (Dimensions excluding handles)  
 Curved door



06



07

**Top Freezer Refrigerators**



01

Ⓜ  
**E521TRX3,**  
**E521TLX3**  
**Top Freezer Refrigerator**  
 H1695 x W790 x D715mm  
 (Dimensions excluding handles)  
 Curved door

Ⓜ  
**E411TRX2**  
**Top Freezer Refrigerator**  
 H1695 x W635 x D715mm  
 (Dimensions excluding handles)  
 Curved door

Ⓜ  
**E521TRT3,**  
**E521TLT3**  
**Top Freezer Refrigerator**  
 H1695 x W790 x D715mm  
 (Dimensions excluding handles)  
 Curved door



02



03

Top Freezer Refrigerators Cont.



04

④  
**E411TRE2**  
 Top Freezer Refrigerator  
 H1695 x W635 x D715mm  
 (Dimensions excluding handles)  
 Curved door

④  
**E415HRX2**  
 Top Freezer Refrigerator  
 H1695 x W635 x D715mm  
 (Dimensions excluding handles)  
 Curved door

④  
**E415HRE2**  
 Top Freezer Refrigerator  
 H1695 x W635 x D715mm  
 (Dimensions excluding handles)  
 Curved door



05



06

Vertical Refrigerators



01

④  
**E450RXFD,**  
**E450LXFD**  
 H1695 x W635 x D695mm  
 (Dimensions excluding handles)  
 Flat door

Vertical Freezers



01

④  
**E388RXFD,**  
**E388LXFD**  
 H1695 x W635 x D695mm  
 (Dimensions excluding handles)  
 Flat door

CLEEANN



## WE LIVE OUT OF DRAWERS

Fisher & Paykel DishDrawer™ dishwashers are designed to make doing the dishes easier than ever before. The combination of a drawer-based system with smart electronics and independent wash technology delivers unparalleled cleaning and better ergonomics. We call it DishDrawer™ technology. Each of our DishDrawer™ products is a self-contained dishwasher with technology that allows traditional double-format or separate modules to be configured at an ergonomic height, allowing complete design freedom. Wide, tall, double and single-drawer options allow you to choose the combination that works best for your lifestyle. The dishwashers in this range can be concealed easily behind kitchen cabinetry to seamlessly blend in with your kitchen and the ergonomic design minimises bending by requiring less movement to open, load and close.



DISHDRAWER  
TECHNOLOGY





Fluorocarbon Free



---

## DishDrawer™ Wide

---

Designed for the whole family, the DishDrawer™ Wide dishwasher complements the Fisher & Paykel 900mm product range to deliver a total kitchen solution. Providing space for nine place settings, the DishDrawer™ Wide is suited to medium-sized households and can be partnered with additional drawers to cater for larger families.

---

### 1 Innovative

---

Before washing begins, detergent passes through the world's first flow-through dispenser to ensure it is thoroughly dissolved, providing a faster, more hygienic wash with no hint of detergent burn.

---

### 2 Convenient

---

This model is taller than the standard DishDrawer™ dishwasher, so you can fit large plates up to 315mm in diameter. Racking is designed to hold long utensils and can fold away to free up space.

---

### 3 Ergonomic

---

The DishDrawer™ is as easy to open and close as a kitchen drawer and conveniently positioned at bench height so loading and unloading requires minimal bending. Easy-to-use folding tines allow you to place large pots, platters and bowls into the drawer with ease.

---

### 4 Efficient

---

This model has the choice of nine wash programs, including Eco options to minimise water and energy usage.

---

### 5 Safe

---

For added safety, a key lock and child lock are included.

---

### 6 Eco-friendly

---

Uses only 9.4 litres of water on a Normal Eco wash program.

---

---

## DishDrawer™ Tall

---

This model is designed for extra headroom. The increased drawer height fits 330mm plates, making cleaning up after dinner parties a breeze. The DishDrawer™ Tall dishwasher can also easily accommodate oversized platters and extra-long stemmed glasses.

---

### 1 Innovative

Before washing begins, detergent passes through the world's first flow-through dispenser to ensure it is thoroughly dissolved, providing a faster, more hygienic wash with no hint of detergent burn.

---

### 2 Convenient

This model is taller than the standard DishDrawer™ dishwasher, so you can fit in large plates up to 330mm in diameter. Racking is designed to hold long utensils and can fold away to free up space.

---

### 3 Ergonomic

The DishDrawer™ is as easy to open and close as a kitchen drawer and conveniently positioned at bench height so loading and unloading requires minimal bending. Easy-to-use folding tines allow you to place large pots, platters and bowls into the drawer with ease.

---

### 4 Efficient

This model has the choice of nine wash programs, including Eco options to minimise water and energy usage.

---

### 5 Safe

For added safety, a key lock and child lock are included.

---

### 6 Ecofriendly

Uses only 6.7 litres of water on a Normal Eco wash program.

---



---

### DishDrawer™ Double

---

Designed to fit existing kitchen cabinetry, the DishDrawer™ Double dishwasher has comparable dimensions to those of traditional dishwashers but provides the benefit of two independent drawers for added convenience and ergonomics.

---

#### 1 Innovative

---

This dishwasher is a world's first in terms of design and configuration. Before washing begins, detergent passes through the world's first flow-through dispenser to ensure it is thoroughly dissolved, providing a faster, more hygienic wash with no hint of detergent burn.

---

#### 2 Convenient

---

The DishDrawer™ Double dishwasher lets the user match the wash program to the exact load type in each drawer.

---

#### 3 Ergonomic

---

The DishDrawer™ is as easy to open and close as a kitchen drawer and conveniently positioned at bench height so loading and unloading requires minimal bending. Easy-to-use folding tines allow you to place large pots, platters and bowls into the drawer with ease.

---

#### 4 Efficient

---

This model offers the choice of nine wash programs, including Eco options to minimise water and energy usage.

---

#### 5 Safe

---

For added safety, a key lock and child lock are included.

---

#### 6 Eco-friendly

---

Uses only 6.7 litres of water per drawer on a Normal Eco wash program.

---





#### **INTEGRATED MODELS**

The integrated product solution enables seamless fitting between Fisher & Paykel products and your kitchen cabinetry. Your chosen aesthetic can extend beyond storage spaces to enable DishDrawer™ and CoolDrawer™ to blend in with your kitchen environment.

---

## DishDrawer™ Range Features

---

---

### 1 Independent Drawers

---

An independent drawer-based dishwashing platform is part of what makes the DishDrawer™ dishwasher unique. At bench height, drawers glide open for easy access, visibility and better ergonomics. In DishDrawer™ Double dishwashers, both drawers operate independently so different wash cycles can operate simultaneously to accommodate a variety of loads. Glasses, pots and pans can be washed in separate drawers at the same time.



---

### 2 SmartDrive™ Wash Mechanism

---

The unique brushless DC motor acts as both a wash pump and a drain pump, which means fewer moving parts and greater reliability. The pump brings water into the spray arm, which rotates at different speeds depending on the wash cycle selected, to deliver a superior clean and better dish care. In the DishDrawer™ Wide dishwasher, two independent spray arms force water throughout the tub, ensuring maximum efficiency and ultimate wash performance.



---

### 3 Nine Wash Options

---

All DishDrawer™ dishwashers feature nine wash programs: Rinse, Fast Eco, Fast, Delicate Eco, Delicate, Normal Eco, Normal, Heavy Eco, Heavy. The range of settings enables the DishDrawer™ dishwasher to wash everything from fine glass and crystal to heavily soiled pots and pans at the touch of a button. Primary and secondary controls provide a simple interface for program selection and operation, while the 'delay' start setting means the dishes can be done when it's most convenient.



---

### 4 Flow-through Detergent Dispenser

---

The DishDrawer™ dishwasher detergent dispenser ensures that undissolved detergent does not enter into the tub; instead, it is mixed as the machine fills with water. This not only cleans each load better but also reduces the possibility of damaging delicate items such as aluminium, cutlery or porcelain glazes.



---

### 5 Superior Filtration

---

One of the challenges in all dishwashers is a robust filter system that removes debris and avoids blocking. Together, the kidney filter and overmoulded filter plate create a firm seal to ensure that debris does not enter the wash mechanism and cause backflow. It is designed to be removable for easy and hygienic cleaning.



---

### 6 Adjustable Racking System

---

The DishDrawer™ dishwasher includes a range of flexible racking options. The cutlery basket can be customised for different utensils. Folding tines can be folded flat to accommodate a full load of pots or be folded upwards to hold glassware. Pitch-adjustable racks can accommodate normal plates, deep bowls or even slide completely out of the way. Wine glass holders ensure that short and long stemmed glasses are secure throughout the wash. Added retainer clips are ideal for holding chopping boards in position.



---

### 7 Safety Features

---

The DishDrawer™ dishwasher incorporates unique safety features such as a child lock which both locks the drawer to prevent opening and disables the buttons. In addition, it includes three-stage flood protection: the high-strength hose withstands water pressure several times greater than normal, overflow detection cuts the water supply if limits are exceeded and the back-up switch activates the drain pump to remove any excess water.



**DishDrawer™  
Wide Dishwashers**



01



02



03

④  
**DD90SDFTX2,  
DD90SDFHTX2**  
H478 x W895 x D571mm

④  
**DD90STI2**  
H478 x W855 x D569 – 573mm  
Apply your own cabinetry façade  
and handle – not included

④  
**DD90SHTI2**  
H478 x W855 x D569 – 573mm  
Apply your own cabinetry façade  
and handle – not included

**DishDrawer™  
Tall Dishwashers**



01



02

④  
**DD60SDFTX7,  
DD60SDFHTX7**  
H478 x W599 x D571mm

④  
**DD60SHTI7**  
H454 – 478 x W599 x  
D569 – 573mm  
Apply your own cabinetry façade  
and handle – not included

**DishDrawer™  
Double Dishwashers**



01



02



03



04

④  
**DD60DDFX7,  
DD60DDFHX7**  
H820 – 880 x W599 x D571mm

④  
**DD60DI7**  
H820 – 880 x W599 x  
D569 – 573mm  
Apply your own cabinetry façade  
and handle – not included

④  
**DD60DIH7**  
H820 – 880 x W599 x  
D569 – 573mm  
Apply your own cabinetry façade  
and handle – not included

④  
**DD60DCHX7**  
H820 – 880 x W599 x D582mm

**DishDrawer™  
Single Dishwashers**



01



02



03



04

④  
**DD60SDFX7,  
DD60SDFHX7**  
H410 x W599 x D571mm

④  
**DD60SI7**  
H410 x W599 x D569 – 573mm  
Apply your own cabinetry façade  
and handle – not included

④  
**DD60SIH7**  
H410 x W599 x D569 – 573mm  
Apply your own cabinetry façade  
and handle – not included

④  
**DD60SCHX7**  
H410 x W599 x D582mm

WAS SH





## WASHING REINVENTED

It takes a lot of brainpower to make things really simple. That, in a sentence, is the essence of SmartDrive™. Traditional washing machines are made up of many moving parts. Their complexity also means there's a lot that can go wrong with them. Fisher & Paykel SmartDrive™ machines are made of just three main parts: a small computer, a flexible agitator and a simple direct-drive motor. This means these washing machines can sense each load, use less water and be ultimately more reliable as they run with less moving parts.



POWERED BY  
SMARTDRIVE



---

## FabricSmart™

---

The FabricSmart™ washing machine is so intelligent it's almost human. It's the only washing machine in the world with true Fabric Sensing technology. Whether it is your favourite shirt or your most loved toy, this machine will deliver the ultimate clothes care.

---

### 1 Innovative

---

SmartDrive™ technology uses a direct drive motor, controlled by a microprocessor, to make an efficient washer. It can accelerate to a maximum spin speed of 1000rpm, removing more water and reducing drying times.

---

### 2 Intuitive

---

FabricSmart™ uses SmartDrive™ technology and flexible agitator fins to sense the average fabric mix of the wash load and designs a wash cycle for it. Fabric Sensing technology means the water level, wash action, wash time and rinse type are always optimised.

---

### 3 Convenient

---

An easy to use LCD screen lets you choose from 13 pre-programmed wash cycles, including Nappy Rinse, Duvet/Doona, Allergy, Sweaty, Muddy, Sport Shoes, Beach Gear, Chocolate, Tomato, Blood/Grass, Fruit/Wine, Bowl Clean, and Max Wash. The self-cleaning lint removal system hygienically disposes of lint automatically.

---

### 4 Ecofriendly

---

The FabricSmart™ has a unique Eco-Active™ Wash that uses a small amount of sudsy water and re-circulates it through the clothes, optimising detergent and energy use. By selecting one of the Save Water options you can save up to 35% more water than traditional top loaders.

---

### 5 Ergonomic

---

The ergonomic design of our top-loading format reduces excessive bending or crouching.

---

---

## WashSmart™

---

The WashSmart™ washing machine is designed for those who like fingertip control, without getting their hands dirty. With five wash cycles, including three new cycles specifically designed to suit the diverse needs of family life and three options: Eco, Soak and Quick Wash. Automatic temperature sensing and automatic water level sensing enables a more effective wash.

---

### 1 Innovative

---

SmartDrive™ technology uses a direct drive motor, controlled by a microprocessor, to make an efficient washer. It can accelerate to a maximum spin speed of 1000rpm, removing more water and reducing drying times.

---

### 2 Convenient

---

WashSmart™ uses SmartDrive™ technology with a flexible finned agitator for ultimate load sensing and clothes care. It has five wash cycles to choose from including Allergy, Handwash and Easy Iron, and three wash Options: Eco, Soak and Quick Wash. The Allergy cycle has been designed along Asthma and Allergy Foundation of American guidelines and removes dust mite waste and detergent residue. The Handwash cycle is designed for delicate items. The Easy Iron cycle is designed to minimise the need for ironing. Hang garments on a coat hanger to dry and some will require a light touch-up, or no ironing at all. The self-cleaning lint removal system hygienically disposes of lint automatically.

---

### 3 Precise

---

The automatic temperature sensing uses an in-built thermometer to precisely mix water to the required temperature. This saves power by making washing in cooler temperatures possible throughout the year.

---

### 4 Ergonomic

---

The ergonomic design of our top-loading format reduces excessive bending or crouching.

---





---

## SmartDrive™ Top Loader Range Features

---

---

### 1 SmartDrive™ Technology

---

To deliver the best clothes care, reduced energy and water consumption and greater reliability, Fisher & Paykel washing machines are powered by SmartDrive™ technology. SmartDrive™ comprises just three main parts: a small computer, a flexible agitator, and a simple direct-drive motor that allow these washing machines to sense each load, use less water and run with less moving parts.

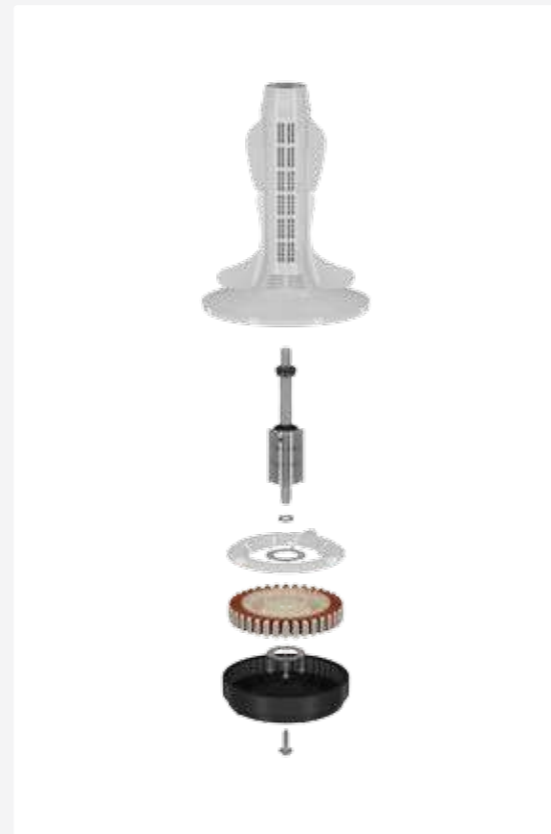

---

### 2 1000rpm Spin

---

All SmartDrive™ washers spin to a speed of 1000rpm. They remove up to 2½ litres more water per load than other washing machines, reducing drying time and drying costs.



---

### 3 Self-Cleaning Lint Disposal

---

All SmartDrive™ washers have a self-cleaning lint disposal system. The water and lint are drawn down the agitator and through the inner and outer bowls. The holes in the stainless bowl trap the lint, which is flushed down the drain. This is a hygienic way of dealing with lint. There is no need for you to touch the lint and no contamination of micro-organisms growing in filters.



---

### 4 Auto Water Level Sensing

---

SmartDrive™ technology is used to determine the right amount of water for each load. People often over-estimate the amount of water required for each load. Washing is a chemical reaction, so too much water means a diluted detergent solution, and less soil removal.



---

### 5 Automatic Temperature Sensing

---

The SmartDrive™ control system uses an in-built thermometer to precisely mix water to the required temperature. This saves power by making washing in cooler temperatures possible throughout the year. It ensures you get better performance.







#### **FRONT LOADERS NOW POWERED BY SMARTDRIVE™**

World-first SmartDrive™ technology is re-engineered for Fisher & Paykel's Front Loader range. By combining smart electronics with vector control and a direct drive motor, the need for a belt and pulley is removed and the motor constantly provides feedback to the computer controlling the tumble and spin action. With 20 years of experience using this technology in Top Loaders, the result is a quieter, quicker and more reliable product.

---

### WashSmart™

---

WashSmart™ provides 13 specific wash cycles and hands-on control to select exactly how you want to wash each load. It is designed for those who like fingertip control, without getting their hands dirty. WashSmart™ has all the clothes care benefits of a front loader, but with SmartDrive™ technology to give a quicker, quieter wash.

---

#### 1 Innovative

---

The Vortex wash speeds up the cleaning process so nine of the 13 cycles take less than an hour to complete when washing at 30°C. It quite simply uses the force of the spinning drum to thrust the detergent solution through the clothes. The Vortex wash means the Everyday cycle can be used for all load sizes.

---

#### 2 Convenient

---

The 'add a garment' option allows you to quickly add or remove a garment mid cycle. A 'wrinkle free' option ensures your wet clothes don't sit around too long at the completion of the cycle and a choice of three soil levels gives you more control over your wash.

---

#### 3 Efficient

---

A maximum spin speed of 1400rpm removes more water from each load, reducing drying times while keeping clothes soft.

---

#### 4 Ecofriendly

---

WashSmart™ delivers both energy and water savings making it one of the most efficient front loaders on the market.

---

Available in July 2013



---

**QuickSmart™**

---

QuickSmart™ offers one touch control with nine programmed cycles. It is designed for you to select and walk away leaving this SmartDrive™ front loader to get on with the job on its own—taking time out of washing so you can spend more time living.

---

**1 Innovative**

---

Using the Vortex wash to speed up the cleaning process, seven of the nine cycles take less than an hour to complete when washing at 30°C.

---

**2 Convenient**

---

Fisher & Paykel's SmartDrive™ contains no belts or pulleys, for a more reliable washer with less vibration and whisper quiet noise levels.

---

**3 Efficient**

---

A maximum spin speed of 1100rpm removes more water from each load, reducing drying times while keeping clothes soft.

---

**4 Ecofriendly**

---

QuickSmart™ delivers both energy and water savings.

---

Available in July 2013





---

## SmartDrive™ Front Loader Range Features

---

---

### 1 SmartDrive™ Technology

---

Fisher & Paykel SmartDrive™ washing machines use our world first direct drive technology, which has revolutionised clothes washing and clothes care since the 1990s. By combining smart electronics with vector control and a direct drive motor, removing the belt and pulleys, these washing machines can sense and respond to each load, delivering exceptional clothes care quickly and quietly.



---

### 2 Quick Vortex Wash Cycles

---

Fisher & Paykel have developed the Vortex wash which speeds up the cleaning process so most cycles take less than an hour to complete. This is like an explosion in the midst of the tumble action which thrusts the sudsy water from the bottom of the drum into and through the clothes. By getting the cleaning agents and heat into the fibres of the clothes quicker the clothes get clean quicker.



---

### 3 Whisper Quiet

---

Our SmartDrive™ Front Loaders use our latest generation direct drive motors, removing cumbersome parts and improving our ability to sense what's happening inside the drum. Without these old components, SmartDrive™ Front Loaders are more reliable, produce less vibration and noise levels are reduced to being whisper quiet.



---

### 4 SmartTouch™ Control Dial

---

The SmartTouch™ Control Dial is your interface to SmartDrive™ technology. It distils 21 years of SmartDrive™ development into a user-friendly interface, to deliver an expert wash every time.



---

### 5 Energy and Water Efficiency

---

Our SmartDrive™ Front Loaders are one of the most efficient front loaders on the market.



---

### 6 Hot and Cold Fill

---

Unlike many others, our SmartDrive™ Front Loaders let you choose whether your water is heated in the washing machine or from your hot water cylinder. With energy efficient quicker wash cycles, environmental and cost savings in mind, Fisher & Paykel Front Loaders can be installed with just a cold water inlet or both hot and cold water inlets—ideal for those with alternative water heating solutions.





**WashSmart™  
Top Load Washer**



⑩  
**WA10T65GW1**  
10.5kg WashSmart™ Washer  
H1030—1050 x W650 x D650mm

⑪  
**WA85T60GW1**  
8.5kg WashSmart™ Washer  
H1030—1050 x W600 x D600mm

⑫  
**WA75T56GW1**  
7.5kg WashSmart™ Washer  
H1030—1050 x W560 x D560mm

**QuickSmart™  
Top Load Washer**



⑬  
**WA75T56MW1**  
7.5kg QuickSmart™ Washer  
H1030—1050 x W560 x D560mm

**FabricSmart™  
Top Load Washers**



⑭  
**WA10T65FW1**  
10.5kg FabricSmart™ Washer  
H1030—1050 x W650 x D650mm

⑮  
**WA85T60FW1**  
8.5kg FabricSmart™ Washer  
H1030—1050 x W600 x D600mm

**WashSmart™  
Front Load Washers**



⑯  
**WH8560P1**  
8.5kg WashSmart™  
Front Load Washer  
H850 x W600 x D645mm

**QuickSmart™  
Front Load Washers**



⑰  
**WH8560J1**  
8.5kg QuickSmart™  
Front Load Washer  
H850 x W600 x D645mm

DRY



#### NEW MOVEMENT IN CLOTHES CARE

The unique Quad Fin system in our dryers is designed to change the way clothes circulate within the dryer drum. The problem with most twin fin dryers is that they tumble clothes in a fixed pattern, causing hot spots and damp spots. The Quad Fin design rotates and propels clothes from the front to the back of the drum in a continuous 360 degree movement, creating faster and more even drying throughout the load. The refreshed compact dryer range offers a range of options tailored to different household needs.

---

### **AeroSense™ Clothes Dryer**

---

The unique Quad Fin system is designed to change the way clothes circulate within the dryer drum. The Quad Fin design rotates and propels clothes from the front to the back of the drum in a continuous 360 degree movement, removing hot spots and creating more even drying throughout the load.

---

**1 Innovative**

Auto-sensing automatically senses when the clothes have reached the required level of dryness, saving you money and time.

---

**2 Convenient**

Delay start time by up to nine hours, so clothes are ready when you want.

---

**3 Ergonomic**

The front access lint filter makes access easy. Can be wall mounted to save space and eliminate bending.

---

**4 Intuitive**

Wrinkle Free means clothes are tumbled through cool air periodically, until you are ready to remove them. This minimises wrinkles, and ironing.

---

**5 Precise**

Five dryness settings plus two temperature settings ensure clothes are dried the way you want them.

---

**6 Ecofriendly**

Autosensing ensures clothes are not over-dried, saving energy.

---





**AeroSense™ Dryer**



01

Ⓜ  
**DE50F56E1**  
**6kg AeroSense™ Dryer**  
H795 x W565 x D560mm

**AeroLogic™ Dryer**



01

Ⓜ  
**DE50F56A2**  
**6kg AeroLogic™ Dryer**  
H795 x W565 x D560mm

**AeroDry™ Dryer**



01

Ⓜ  
**DE40F56A2**  
**4kg AeroDry™ Dryer**  
H795 x W565 x D440mm



## SPECIFICATIONS

<b>Cook</b>	<b>158</b>
<b>Specifications</b>	<b>160</b>
Built-in Ovens	160
Kitchen Companion Products	164
Cooktops	167
Freestanding Cookers	173
Rangehoods	175

<b>Cool</b>	<b>180</b>
<b>Specifications</b>	<b>182</b>
CoolDrawer™	182
Integrated Refrigerator	182
French Door Refrigerators	183
Ice & Water Refrigerators	184
Bottom Freezer Refrigerators	185
Top Freezer Refrigerators	188
Vertical Refrigerators	191
Vertical Freezers	191
<b>Dimensions</b>	<b>192</b>
CoolDrawer™	192
Integrated Refrigerator	192
French Door Refrigerators	193
Ice & Water Refrigerators	194
Bottom Freezer Refrigerators	196
Top Freezer Refrigerators	197
Vertical Refrigerators	198
Vertical Freezers	199

<b>Clean</b>	<b>200</b>
<b>Specifications</b>	<b>202</b>
DishDrawer™ Wide Dishwashers	202
DishDrawer™ Tall Dishwashers	204
DishDrawer™ Double Dishwashers	206
DishDrawer™ Single Dishwashers	208
<b>Wash</b>	<b>210</b>
<b>Specifications</b>	<b>212</b>
Top Loaders	212
Front Loaders	215
<b>Dry</b>	<b>216</b>
<b>Specifications</b>	<b>218</b>
Dryers	218

COOK



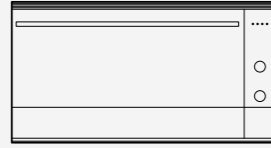

<b>Type of appliance</b>	<b>90cm Single Pyrolytic Built-in Oven</b>
<b>Model no.</b>	<b>OB90S9MEPX2</b>
<b>Finish</b>	<b>Black reflective glass Brushed stainless steel</b>
<b>Dimensions</b>	H478 x W895 x D566mm
Total capacity	103 litres
Usable capacity	87 litres
Shelf positions	4
<b>Oven functions</b>	9
Bake	●
Fan Bake	●
Pastry Bake	●
Grill	●
Fan Grill	●
Fan Forced	●
Warm	●
Pyrolytic Self-Clean	●
Rotisserie	●
<b>Performance</b>	
Grill	4050W
Rapid pre-heat	●
<b>Cleaning</b>	
Acid resistant graphite enamel	●
Pyrolytic self-clean	●
Removable shelf runners	●
Removable oven door	●
Removable liner door glass	●
<b>Safety</b>	
Cool touch door	●
Door and cavity cooling system	●
Non-tip shelves	●
Control panel key lock	●
Catalytic venting system	●
<b>Controls</b>	
Electronic clock	●
Automatic cooking/minute timer	●
Electronic temperature control	●
Illuminated halo dials	●
Halogen lights	2 x 20W
Sabbath mode	●
Preset cooking temperatures	●
<b>AMP draw</b>	19.1A
<b>Accessories</b>	
Step down wire shelf	●
Flat wire shelf	●
Grill pan + grill rack	●
Flat brushed baking tray	●
Fat filter	●
<b>Warranty</b>	1 year
<b>Available</b>	South East Asia/Middle East/India

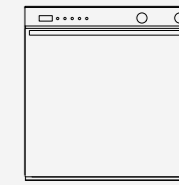
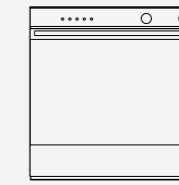
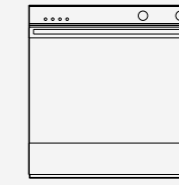
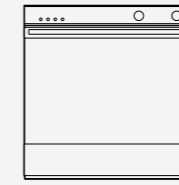

<b>Type of appliance</b>	<b>60cm 11 Function Pyrolytic Built-in Oven</b>	<b>60cm Nine Function Built-in Oven</b>	<b>60cm Seven Function Built-in Oven</b>	<b>60cm Seven Function Built-in Oven</b>
<b>Model no.</b>	<b>OB60SL11DEPX1</b>	<b>OB60SL9DEX1</b>	<b>OB60SL7DEX1</b>	<b>OB60SL7DEW1</b>
<b>Finish</b>	<b>Black reflective glass Polished metal trim</b>	<b>Black reflective glass Polished metal trim</b>	<b>Black reflective glass Polished metal trim</b>	<b>White Polished metal trim</b>
<b>Dimensions</b>	H598 x W596 x D580mm	H598 x W596 x D580mm	H598 x W596 x D580mm	H598 x W596 x D580mm
Total capacity	90 litres	90 litres	90 litres	90 litres
Usable capacity	77 litres	77 litres	77 litres	77 litres
Shelf positions	6	6	6	6
<b>Oven functions</b>	11	9	7	7
Bake	●	●	●	●
Vent Bake	●	●		
Fan Bake	●	●	●	●
Fan Forced	●	●	●	●
Grill	●	●	●	●
Fan Grill	●	●	●	●
Classic Bake	●	●	●	●
Pastry Bake	●	●	●	●
Roast	●	●		
Warm	●	●		
Pyrolytic Self-Clean	●			
<b>Performance</b>				
Grill	3200W	3200W	3000W	3000W
AeroTech™ technology	●	●	●	●
ActiveVent™ system	●	●	●	●
Automatic rapid pre-heat	●	●		
<b>Cleaning</b>				
Acid resistant graphite enamel	●	●	●	●
Drop down grill element		●	●	●
Pyrolytic self-clean	Standard and light cycles			
Self-cleaning catalytic liners		Sides	Optional	Optional
Removable shelf runners	●	●	●	●
Removable oven door/inner glass	●	●	●	●
<b>Safety</b>				
Cool touch door	●	●	●	●
Advanced cooling system	●	●	●	●
Balanced oven door	●	●	●	●
Non-tip shelves	●	●	●	●
Full extension telescopic shelves	●	●	Optional	Optional
Control panel key lock	●	●	●	●
Catalytic venting system	●	●	●	●
<b>Controls</b>				
Electronic clock	●	●	●	●
Automatic cooking/minute timer	●	●	●	●
Precise electronic temperature control	●	●		●
Automatic pre-set temperatures	●	●		
Capacitive touch controls	●	●		
Illuminated halo dials	●	●		
Interior light	2 x 25W (halogen)	2 x 25W (halogen)	25W	25W
Audio feedback	●	●		
Celsius/Fahrenheit temperature	●	●		
Sabbath mode	●	●		
<b>AMP draw</b>	15.5A	15.5A	13.0A	13.0A
<b>Accessories</b>				
Step down wire shelf	●	●	●	●
Flat wire shelf	●	●	●	●
Telescopic slides	2	2	Optional	Optional
Flat brushed baking tray	●	●	●	●
Roasting dish and grill rack set	●	●	●	●
Smokeless grill tray	●	●		
Catalytic liners		Sides	Optional	Optional
Rotisserie set	Optional	Optional		
Meat probe	●			
<b>Warranty</b>	1 year	1 year	1 year	1 year
<b>Available</b>	South East Asia/Middle East/India	South East Asia/Middle East/India	South East Asia/Middle East/India	South East Asia/Middle East/India

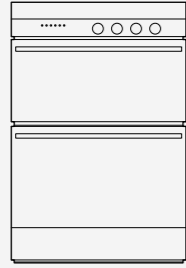

<b>Type of appliance</b>	<b>60cm Double Built-in Oven</b>
<b>Model no.</b>	<b>OB60B77DEX3</b>
<b>Finish</b>	<b>Black reflective glass Brushed stainless steel</b>
<b>Dimensions</b>	H888 x W595 x D567mm
Total capacity	45 + 71 litres
Usable capacity	36 + 58 litres
Shelf positions	4 (top oven), 6 (bottom oven)
<b>Oven functions</b>	7
Bake	●
Fan Bake	●
Grill	●
Fan Grill	●
Fan Forced	●
Warm	●
Defrost	●
<b>Performance</b>	
Grill	2700W (top oven), 3000W (bottom oven)
<b>Cleaning</b>	
Acid resistant graphite enamel	●
Drop down grill element	Bottom oven
Self-cleaning catalytic liners	Sides and rear
Removable shelf runners	●
Removable oven door/s	●
Removable liner door glass	●
<b>Safety</b>	
Cool touch door	●
Door and cavity cooling system	●
Non-tip shelves	●
Telescopic sliding runners	●
<b>Controls</b>	
Electronic clock	●
Automatic cooking/minute timer	Bottom oven
Rear light	Top oven
Side and rear lights	Bottom oven
<b>AMP draw</b>	25.4A
<b>Accessories</b>	
Step down wire shelf	●
Flat wire shelf	2
Telescopic sliding runners	3 sets
Grill pan + grill rack	●
Flat brushed baking tray	●
Fat filter	●
Catalytic liners	Sides and rear
<b>Warranty</b>	1 year
<b>Available</b>	India

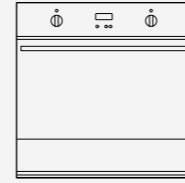

<b>Type of appliance</b>	<b>60cm Single Built-in Oven</b>
<b>Model no.</b>	<b>OB60SCMX4</b>
<b>Finish</b>	<b>Black reflective glass Brushed stainless steel</b>
<b>Dimensions</b>	H597 x W595 x D567mm
Total capacity	71 litres
Usable capacity	58 litres
Shelf positions	6
<b>Oven functions</b>	4
Bake	●
Fan Bake	●
Grill	●
Fan Grill	●
<b>Performance</b>	
Grill	3000W
<b>Cleaning</b>	
Acid resistant graphite enamel	●
Drop down grill element	●
Self-cleaning catalytic liners	Sides
Removable shelf runners	●
Removable oven door/s	●
<b>Safety</b>	
Door and cavity cooling system	●
Non-top shelves	●
<b>Controls</b>	
Electronic clock	●
Automatic cooking/minute timer	●
Side and rear lights	●
<b>AMP draw</b>	13.3A
<b>Accessories</b>	
Step down wire shelf	●
Flat wire shelf	●
Grill pan + grill rack	●
Flat brushed baking tray	●
Fat filter	●
Catalytic liners	Optional
<b>Warranty</b>	1 year
<b>Available</b>	Middle East/India

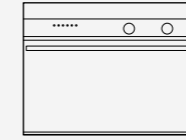

<b>Type of appliance</b>	<b>60cm Compact Built-in Oven</b>
<b>Model no.</b>	<b>OB60NDEX2</b>
<b>Finish</b>	<b>Black reflective glass Brushed stainless steel</b>
<b>Dimensions</b>	H450 x W595 x D556mm
Total capacity	45 litres
Usable capacity	36 litres
Shelf positions	4
<b>Oven functions</b>	7
Bake	●
Fan Bake	●
Grill	●
Fan Grill	●
Fan Forced	●
Warm	●
Defrost	●
<b>Performance</b>	
Grill	2700W
<b>Cleaning</b>	
Acid resistant graphite enamel	●
Removable shelf runners	●
Removable oven door/s	●
<b>Safety</b>	
Cool touch door	●
Door and cavity cooling system	●
Non-top shelves	●
<b>Controls</b>	
Electronic clock	●
Automatic cooking/minute timer	●
Rear light	●
<b>AMP draw</b>	12.8A
Step down wire shelf	●
Grill pan + grill rack	●
Flat brushed baking tray	●
Fat filter	●
<b>Warranty</b>	1 year
<b>Available</b>	South East Asia/Middle East/India



<b>Type of appliance</b>	<b>60cm Built-in Conventional Compact Oven</b>
<b>Model no.</b>	<b>OB60N8DTX1</b>
<b>Finish</b>	<b>Black reflective glass Polished metal trim</b>
<b>Dimensions</b>	H457 x W595 x D570mm (Height 478mm with optional lower trim kit)
Total capacity	40 litres
Usable capacity	36 litres
Shelf positions	3
<b>Eight Oven Functions</b>	
Defrost	●
Traditional	●
Double Fan Assisted	Bottom element
Grill	●
Medium Grill	●
Fan Assisted Grill	●
Turbo Plus	●
Traditional Fan Assisted	●
<b>Performance</b>	
Thermostat regulation	35-275°C
Powerful grill element	●
<b>Cleaning</b>	
Easy clean enamel interior	●
Catalysing filter to remove odours	●
Easy clean glass inner door	●
Removable door panes	●
<b>Safety</b>	
Child safety lock	●
Safe touch door (two removable panes)	Triple glazed
Safety thermostat	●
<b>Controls</b>	
Electronic capacitive touch controls	●
Intuitive information display	●
Recipe function	●
Digital temperature control	●
Electronic clock	●
Minute minder	●
Programmable oven timer	●
Interior light	●
<b>AMP draw</b>	16A
<b>Accessories</b>	
Enamel tray	●
Shelf	●
Optional lower trim kit	Makes product 478mm high
<b>Warranty</b>	1 year
<b>Available</b>	South East Asia/Middle East/India



<b>Type of appliance</b>	<b>60cm Built-in Steam Oven</b>
<b>Model no.</b>	<b>OS60NDTX1</b>
<b>Finish</b>	<b>Black reflective glass Polished metal trim</b>
<b>Dimensions</b>	H457 x W595 x D423mm (Height 478mm with optional lower trim kit)
Total capacity	29 litres
Usable capacity	23 litres
<b>Eight Steam Functions</b>	
Also features:	
Electronic programmer	●
Preset temperature	●
Auto-clock	●
Water indicator	●
<b>Performance</b>	
Thermostat regulation	55-100°C
Steam generator	1.78kW
Steam generator/bottom part oven	●
Steam at 100°C	●
<b>Cleaning</b>	
Easy clean stainless steel interior	●
Removable water tank	●
<b>Safety</b>	
Child safety lock	●
Glazed door	●
Safety thermostat	●
<b>Controls</b>	
Electronic capacitive touch controls	●
Intuitive information display	●
Interior light	●
<b>AMP draw</b>	10A
<b>Accessories</b>	
Two piece steaming dish	●
Support rack	●
Optional lower trim kit	Makes product 478mm high
<b>Warranty</b>	1 year
<b>Available</b>	South East Asia/Middle East/India

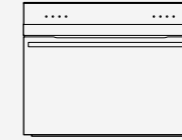

<b>Type of appliance</b>	<b>60cm Built-in Combination Microwave Oven</b>
<b>Model no.</b>	<b>OM36NDXB1</b>
<b>Finish</b>	<b>Black reflective glass Polished metal trim</b>
<b>Dimensions</b>	H457 x W595 x D570mm (Height 478mm with optional lower trim kit)
Total capacity	40 litres
Usable capacity	36 litres
Shelf positions	3
<b>10 Functions</b>	
Microwave Max	●
Microwave by levels	●
Grill High	●
Grill Medium	●
Grill High + Microwave	●
Grill Medium + Microwave	●
Heat Circulation	●
Microwave + Heat Circulation	●
Defrost	●
Warm	●
<b>Performance</b>	
Thermostat regulation	35-220°C
Microwave power	1000W
Grill power	1800W
19 Power levels	●
Full width dual variable grill	●
Turbo plus fan controlled cooking	●
<b>Cleaning</b>	
Easy clean enamel interior	●
Easy clean glass inner door	●
Fold down grill	●
Removable side racks	●
<b>Safety</b>	
Child safety lock	●
Glazed door	Triple glazed
Safety thermostat	●
<b>Controls</b>	
Electronic capacitive touch controls	●
Intuitive information display	●
Interior light	25W
<b>AMP draw</b>	16A
<b>Accessories</b>	
Turntable	●
Glass tray	●
Rack	●
Optional lower trim kit	Makes product 478mm high
<b>Warranty</b>	1 year
<b>Available</b>	South East Asia/Middle East/India

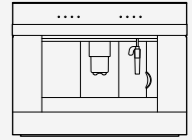

<b>Type of appliance</b>	<b>60cm Built-in Coffee Maker</b>
<b>Model no.</b>	<b>EB60DSXB1</b>
<b>Finish</b>	<b>Black reflective glass Polished metal trim</b>
<b>Dimensions</b>	H457 x W595 x D412mm (Height 478mm with optional lower trim kit)
Number of cups	1 or 2
<b>Functions</b>	
Coffee strength in 5 levels	Extra-strong, Strong, Medium, Mild, Extra-mild
Cup size in 5 levels	Espresso "MyCup", Small, Medium, Large, Mug
Personalisation of cup sizes and cappuccino (milk + coffee) via menu	●
Takes pre-ground coffee	●
<b>Performance</b>	
Coffee temperature	3 temperatures
15 bar pump pressure	●
System heating power (Coffee/Steam)	1200W/1000W
Grinding coarseness	13 positions
Water tank capacity	1.8 litres
<b>Cleaning</b>	
Self clean function	●
Easy to remove coffee grinds bin	●
Removable drip tray with level indicator	●
<b>Controls</b>	
Electronic capacitive touch controls	●
Intuitive information display	●
Water tank empty indicator	●
Cleaning reminder	●
Coffee grounds full reminder	●
Maintenance data reminder	●
Refill coffee bean reminder	●
Lights	●
<b>AMP draw</b>	10A
<b>Accessories</b>	
Coffee spoon	●
Stainless steel milk jug	●
Descaling solution bottle	●
Optional lower trim kit	Makes product 478mm high
<b>Warranty</b>	1 year
<b>Available</b>	South East Asia/Middle East/India



Type of appliance	60cm Warming Drawer	60cm Warming Drawer
<b>Model no.</b>	<b>WB60SDEB1</b>	<b>WB60SDEX1</b>
<b>Finish</b>	<b>Black reflective glass</b>	<b>Stainless steel</b>
<b>Dimensions</b>	H118 x W596 x D555mm	H118 x W596 x D555mm
Useable height	83mm	83mm
Place settings	6	6
Cappuccino cups	20	20
Espresso cups	48	48
Maximum allowable weight	30kg	30kg
<b>Performance</b>		
Low	45°C	45°C
Medium	55°C	55°C
High	65°C	65°C
<b>Cleaning</b>		
Easy clean smooth-glass base	●	●
<b>Safety</b>		
Full extension slides	●	●
Soft closing mechanism	●	●
Automatic turn off after 12 hours	●	●
<b>Controls</b>		
Illuminated capacitive touch controls	●	●
Two automatic timers	1 or 2 hours	1 or 2 hours
On/Off indicator	●	●
<b>Supply voltage</b>	220V - 240V	220V - 240V
<b>AMP draw</b>	1.6 - 1.8A	1.6 - 1.8A
<b>Warranty</b>	1 year	1 year
<b>Available</b>	South East Asia/Middle East/India	South East Asia/Middle East/India

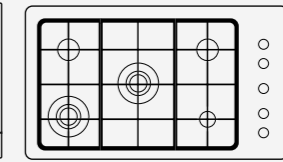
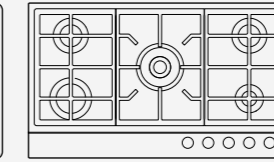
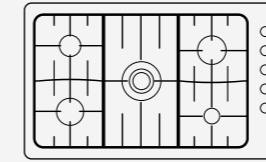

Type of appliance	90cm 5 Burner Gas Cooktop	90cm 5 Burner Gas Cooktop	90cm 5 Burner Gas Cooktop
<b>Model no.</b>	<b>CG905DWACX1</b>	<b>CG905DX1</b>	<b>CG905DWFCX1</b>
<b>Finish</b>	<b>Stainless steel</b>	<b>Stainless steel with polished strip</b>	<b>Stainless steel</b>
<b>Dimensions</b>	H76 x W914 x D546mm	H64 x W900 x D530mm	H50 x W914 x D533mm
<b>Burners</b>	5 including 1 wok burner	5 including 1 dual wok burner	5 including 2 wok burners
<b>Burner ratings (using LPG)</b>			
Auxiliary burner	2.7MJ/h (750W)	3.8MJ/h	4.0MJ/h
Semi rapid burner	6.2MJ/h (1700W)	7.5MJ/h	8.5MJ/h
Rapid burner	9.3MJ/h (2500W)	11.4MJ/h	
Wok burner	15.3MJ/h (4250W)	16.8MJ/h	13.5MJ/h
<b>Burner ratings (using natural gas)</b>			
Auxiliary burner	3.6MJ/h (1000W)	3.6MJ/h	3.6MJ/h
Semi rapid burner	7.2MJ/h (2000W)	8.4MJ/h	8.5MJ/h
Rapid burner	10.5MJ/h (2900W)	11.5MJ/h	
Wok burner	16.3MJ/h (4500W)	16.6MJ/h	15.0MJ/h
<b>Performance</b>			
Innovave™ technology	●		
Electronic ignition	●	●	●
Quick connect gas valve		●	●
LPG compatible	●	●	●
Cast iron trivets	●	●	●
<b>Cleaning</b>			
Easy clean cooktop design	●	●	●
Quick component removal	●	●	●
<b>Safety</b>			
Auto re-ignition system	●		
Flame failure re-ignition system	●		
Flame failure system		●	●
Spill containment	4 litres	2 litres	2.5 litres
<b>Controls</b>			
Satin chrome control dials	●		●
Burner indicator lights	●		
Fault indication lights	●		
Laser etched graphics	●	●	●
Ergonomic control dials		●	
<b>AMP draw</b>	10A	10A	10A
<b>Supply voltage</b>	230 - 240V	230 - 240V	230 - 240V
<b>Accessories</b>			
Wok stand		●	●
Small pan support			●
<b>Warranty</b>	1 year	1 year	1 year
<b>Available</b>	South East Asia/India	South East Asia	South East Asia



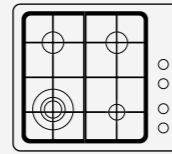
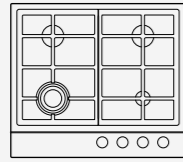

Type of appliance	60cm 4 Burner Gas Cooktop	60cm 4 Burner Gas Cooktop
Model no.	CG604DX1	CG604DWFCX1
Finish	Stainless steel with polished strip	Stainless steel
Dimensions	H64 x W600 x D530mm	H50 x W578 x D511mm
Burners	4 including 1 mini wok burner	4 including 1 wok burner
<b>Burner ratings (using LPG)</b>		
Auxiliary burner	3.8MJ/h	4.0MJ/h (1100W)
Semi rapid burner	7.5MJ/h	8.5MJ/h (2300W)
Wok burner	11.7MJ/h	13.5MJ/h (3750W)
<b>Burner ratings (using natural gas)</b>		
Auxiliary burner	3.6MJ/h	3.6MJ/h (1000W)
Semi rapid burner	8.4MJ/h	8.5MJ/h (2300W)
Wok burner	11.7MJ/h	15.0MJ/h (4100W)
<b>Performance</b>		
Electronic ignition	●	●
Quick connect gas valve	●	●
LPG compatible	●	●
Cast iron trivets	●	●
<b>Cleaning</b>		
Easy clean cooktop design	●	●
Quick component removal	●	●
<b>Safety</b>		
Flame failure system	●	●
Spill containment	1 litre	1.5 litres
<b>Controls</b>		
Satin chrome control dials		●
Laser etched graphics	●	●
Ergonomic control dials	●	
<b>AMP draw</b>	10A	10A
<b>Supply voltage</b>	230-240V	230-240V
<b>Accessories</b>		
Wok stand	●	●
Small pan support		●
<b>Warranty</b>	1 year	1 year
<b>Available</b>	South East Asia	South East Asia/India

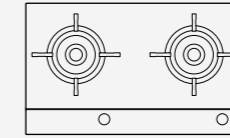
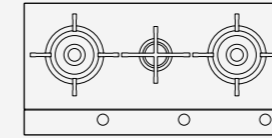

Type of appliance	90cm 3 Burner Gas Cooktop	75cm 2 Burner Gas Cooktop
Model no.	CG903DNGB1 CG903DLPGB1	CG752DNGB1 CG752DLPGB1
Finish	Ceramic glass Stainless steel trim	Ceramic glass Stainless steel trim
Dimensions	H59 x W900 x D450mm	H59 x W750 x D450mm
Burners	3 including 2 dual wok burners	2 including 2 dual wok burners
<b>Burner ratings (using LPG)</b>		
Semi rapid burner	7.5MJ/h	
Wok burner	18MJ/h/2.4MJ/h	18MJ/h/2.4MJ/h
<b>Burner ratings (using natural gas)</b>		
Semi rapid burner	8.3MJ/h	
Wok burner	18MJ/h/2.4MJ/h	18MJ/h/2.4MJ/h
<b>Performance</b>		
LPG/Natural gas models	●	●
Cast iron trivets	●	●
<b>Cleaning</b>		
Easy clean cooktop design	●	●
Quick component removal	●	●
<b>Safety</b>		
Flame failure system	●	●
<b>Controls</b>		
Toughened fused glass graphics	●	●
Controls on cooktop	●	●
Dual wok control	●	●
<b>AMP draw</b>	10A	10A
<b>Supply voltage</b>	230-240V	230-240V
<b>Accessories</b>		
Wok stand	●	●
Small pan support	●	●
<b>Warranty</b>	2 years	2 years
<b>Available</b>	South East Asia	South East Asia

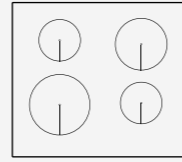
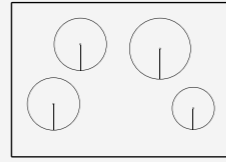
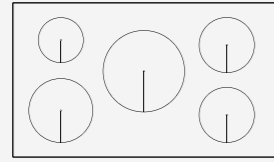

Type of appliance	90cm 5 Zone Induction Cooktop	75cm 4 Zone Induction Cooktop	60cm 4 Zone Induction Cooktop
<b>Model no.</b>	<b>CI905DTB1</b>	<b>CI754DTB1</b>	<b>CI604DTB1</b>
<b>Finish</b>	<b>Ceramic glass</b>	<b>Ceramic glass</b>	<b>Ceramic glass</b>
<b>Dimensions</b>	H50 x W900 x D530mm	H50 x W750 x D530mm	H50 x W600 x D530mm
<b>Cooking zones</b>	5	4	4
<b>Zone ratings</b>	*Maximum power output when set for PowerBoost	*Maximum power output when set for PowerBoost	*Maximum power output when set for PowerBoost
Left front	2300W (3200W*)	1850W (2500W*)	2300W (3700W*)
Right front	1850W (2500W*)	1400W (1800W*)	1400W (1800W*)
Left rear	1400W (1800W*)	1850W (2500W*)	1400W (1800W*)
Right rear	1850W (2500W*)	2300W (3700W*)	1850W (2500W*)
Centre	2400W (3700W*)		
PowerBoost	3700W	3700W	3700W
<b>Performance</b>			
Induction cooking technology	●	●	●
Nine heat settings	●	●	●
Auto heat reduce	●	●	●
GentleHeat	●	●	●
PowerBoost	●	●	●
<b>Cleaning</b>			
Flat easy clean glass surface	●	●	●
<b>Safety</b>			
Key lock	●	●	●
Safety time out	●	●	●
Pan detection system	●	●	●
Surface hot indicators	●	●	●
Spillage auto off	●	●	●
<b>Controls</b>			
Soft touch electronic controls	●	●	●
Minute timer	●	●	●
Auto cut-off timer for each zone	●	●	●
<b>AMP draw</b>	42A	32A	30A
<b>Supply voltage</b>	230-240V	230-240V	230-240V
<b>Warranty</b>	1 year	1 year	1 year
<b>Available</b>	South East Asia/Middle East/India	South East Asia/Middle East/India	South East Asia/Middle East/India

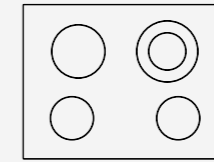
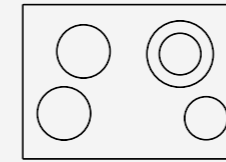

Type of appliance	75cm 4 Element Electric Cooktop	60cm 4 Element Electric Cooktop
<b>Model no.</b>	<b>CE754DTB1</b>	<b>CE604DTB1</b>
<b>Finish</b>	<b>Black ceramic glass</b>	<b>Black ceramic glass</b>
<b>Dimensions</b>	H58 x W750 x D530mm	H58 x W600 x D530mm
<b>Elements</b>	4 including 1 dual element	4 including 1 dual element
<b>Element ratings</b>		
Left front	1800W	1200W
Right front	1200W	1200W
Left rear	1200W	1800W
Right rear	2500W/1100W	2200W/750W
GentleHeat	20W	20W
<b>Performance</b>		
Hi-light high speed ribbon elements	●	●
Dual element	●	●
Auto heat reduce	●	●
<b>Cleaning</b>		
Flat easy clean glass surface	●	●
<b>Safety</b>		
Key lock	●	●
Safety time out	●	●
Individual hot surface indicators	●	●
Temperature limiters	●	●
Spillage auto off	●	●
<b>Controls</b>		
Touch and Slide controls	●	●
Minute timer	●	●
Auto cut-off timer for each element	●	●
<b>AMP draw</b>	28A	28A
<b>Supply voltage</b>	230-240V	230-240V
<b>Warranty</b>	1 year	1 year
<b>Available</b>	South East Asia	South East Asia/Middle East/India

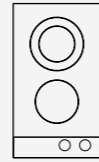
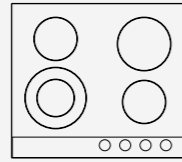
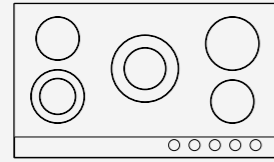

Type of appliance	90cm 5 Element Electric Cooktop	60cm 4 Element Electric Cooktop	30cm 2 Element Electric Cooktop
<b>Model no.</b>	CE905CBX1	CE604CBX1	CE302CBX1
<b>Finish</b>	Black ceramic glass Brushed stainless steel	Black ceramic glass Brushed stainless steel	Black ceramic glass Brushed stainless steel
<b>Dimensions</b>	H59 x W900 x D530mm	H59 x W600 x D530mm	H63 x W300 x D530mm
<b>Elements</b>	5 including 2 dual elements	4 including 1 dual element	2 including 1 dual element
<b>Element ratings</b>			
Left front	1700W/700W	2200W/750W	1200W
Right front	1200W	1200W	1700W/700W
Left rear	1800W	1200W	
Right rear	1200W	1800W	
Centre	2500W/1100W		
GentleHeat	25W		
<b>Performance</b>			
Hi-light high speed ribbon elements	●	●	●
Dual element	●	●	●
<b>Cleaning</b>			
Flat easy clean glass surface	●	●	●
<b>Safety</b>			
Individual hot surface indicators	●	●	●
Temperature limiters	●	●	●
<b>Controls</b>			
Satin chrome control dials	●	●	●
Permanent laser etched graphics	●	●	●
<b>AMP draw</b>	36.5A	28A	13A
<b>Supply voltage</b>	230 - 240V	230 - 240V	230 - 240V
<b>Warranty</b>	1 year	1 year	1 year
<b>Available</b>	South East Asia/India	South East Asia/India	South East Asia/Middle East/India

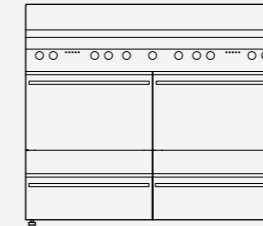

Type of appliance	120cm Freestanding Range
<b>Model no.</b>	OR120DDWGF2
<b>Finish</b>	Brushed stainless steel Black reflective glass
<b>Dimensions</b>	H915 - 927 x W1195 x D600mm
Total capacity	71 + 71 litres
Usable capacity	58 + 58 litres
Shelf positions	6 per cavity
<b>Burners</b>	6 including 2 dual burners
<b>Oven functions</b>	7
Bake	●
Fan Bake	●
Grill	●
Fan Grill	●
Fan Forced	●
Defrost	●
Warm	●
<b>Burner ratings (using natural gas)</b>	
Semi rapid burner	6.3MJ/h
Wok burner	12.7MJ/h
Dual burner	16.0MJ/h / 3.6MJ/h
<b>Performance</b>	
Grill	2000W
Warming drawer	Moist - Crisp setting
Electronic ignition	●
LPG/Natural gas compatible	●
Cast iron trivets	●
<b>Cleaning</b>	
Acid resistant graphite enamel	●
Drop down grill element	●
Self-cleaning catalytic liners	Sides
Removable shelf runners	●
Removable oven door	●
Removable inner door glass	●
<b>Safety</b>	
Cool touch door	●
Advanced cooling system	●
Non-tip shelves	●
Anti-tilt bracket	●
Flame failure	●
<b>Controls</b>	
Satin chrome control dials	●
Electronic clock	●
Automatic cooking/minute timer	●
<b>Accessories</b>	
Step down oven shelf	2
Flat wire shelf	2
Telescopic runners	2 sets
Flat brushed baking tray	2
Roasting dish and grill rack set	2
Grill pan handles	1 set
Fat filter	2
Catalytic liners	Sides
Wok stand	●
Storage compartment	●
<b>Warranty</b>	1 year
<b>Available</b>	South East Asia

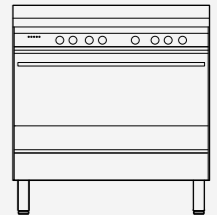

Type of appliance	90cm Freestanding Range
<b>Model no.</b>	OR90SDBGFX2
<b>Finish</b>	Brushed stainless steel Black reflective glass
<b>Dimensions</b>	H892 - 917 x W898 x D600mm
Total capacity	103 litres
Usable capacity	87 litres
Shelf positions	4
<b>Burners</b>	5 including 1 dual burner
<b>Oven functions</b>	8
Bake	●
Fan Bake	●
Grill	●
Fan Grill	●
Fan Forced	●
Defrost	●
Warm	●
Rotisserie	●
<b>Burner ratings (using natural gas)</b>	
Semi rapid burner	6.5MJ/h
Wok burner	11.88MJ/h
Dual burner	16.20MJ/h / 2.4MJ/h
<b>Performance</b>	
Grill	3600W
Electronic ignition	●
LPG/Natural gas compatible	●
Cast iron trivets	●
<b>Cleaning</b>	
Acid resistant graphite enamel	●
Drop down grill element	●
Self-cleaning catalytic liners	Sides
Removable shelf runners	●
Removable oven door	●
Removable inner door glass	●
<b>Safety</b>	
Cool touch door	●
Advanced cooling system	●
Non-tip shelves	●
Anti-tilt bracket	●
Flame failure	●
<b>Controls</b>	
Satin chrome control dials	●
Electronic clock	●
Automatic cooking/minute timer	●
Halogen rear lights	2 x 25W
<b>Accessories</b>	
Step down oven shelf	●
Flat wire shelf	●
Telescopic runners	1 set
Flat brushed baking tray	●
Roasting dish and grill rack set	●
Fat filter	●
Wok stand	●
Catalytic liners	Sides
Rotisserie set	●
Storage compartment	●
<b>Warranty</b>	1 year
<b>Available</b>	South East Asia

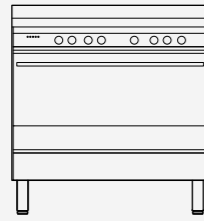

<b>Type of appliance</b>	<b>90cm Freestanding Range</b>
<b>Model no.</b>	<b>OR90SDBGFX2</b>
<b>Finish</b>	<b>Brushed stainless steel Black reflective glass</b>
<b>Dimensions</b>	H892-917 x W898 x D600mm
Total capacity	103 litres
Usable capacity	87 litres
Shelf positions	4
Burners	5 including 1 dual burner
<b>Oven functions</b>	8
Bake	●
Fan Bake	●
Grill	●
Fan Grill	●
Fan Forced	●
Defrost	●
Warm	●
Rotisserie	●
<b>Burner ratings (using natural gas)</b>	
Auxiliary burner	1000W
Semi rapid burner	1750W
Wok burner	3300W
Dual burner	5500W / 650W
<b>Performance</b>	
Grill	2200W
Electronic ignition	●
LPG compatible	●
Cast iron trivets	●
<b>Cleaning</b>	
Acid resistant graphite enamel	●
Drop down grill element	●
Self-cleaning catalytic liners	Sides
Removable shelf runners	●
Removable oven door	●
Removable inner door glass	●
<b>Safety</b>	
Cool touch door	●
Advanced cooling system	●
Non-tip shelves	●
Anti-tilt bracket	●
Flame failure	●
<b>Controls</b>	
Satin chrome control dials	●
Electronic clock	●
Automatic cooking/minute timer	●
Halogen rear lights	2 x 25W
<b>Accessories</b>	
Step down oven shelf	●
Flat wire shelf	●
Telescopic runners	1 set
Flat brushed baking tray	●
Roasting dish and grill rack set	●
Grill pan handles	1 set
Fat filter	●
Wok stand	●
Catalytic liners	Sides
Rotisserie set	●
Storage compartment	●
<b>Warranty</b>	1 year
<b>Available</b>	Middle East (UAE only)

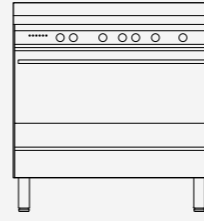

<b>Type of appliance</b>	<b>90cm Freestanding Range</b>
<b>Model no.</b>	<b>OR90SDBSX2</b>
<b>Finish</b>	<b>Brushed stainless steel Black reflective glass</b>
<b>Dimensions</b>	H892-917 x W898 x D600mm
Total capacity	103 litres
Usable capacity	87 litres
Shelf positions	4
Elements	5 including 1 dual element
<b>Oven functions</b>	8
Bake	●
Fan Bake	●
Grill	●
Fan Grill	●
Fan Forced	●
Defrost	●
Warm	●
Rotisserie	●
<b>Element ratings</b>	
Left front	1800W
Right front	1200W
Left rear	1200W
Right rear	1800W
Centre	2200W / 750W
<b>Performance</b>	
Grill	3600W
Hi-light radiant elements	●
Hot surface indicator lights	●
<b>Cleaning</b>	
Flat easy clean glass surface	●
Acid resistant graphite enamel	●
Drop down grill element	●
Self-cleaning catalytic liners	Sides
Removable shelf runners	●
Removable oven door	●
Removable inner door glass	●
<b>Safety</b>	
Cool touch door	●
Advanced cooling system	●
Non-tip shelves	●
Anti-tilt bracket	●
Flame failure	●
<b>Controls</b>	
Satin chrome control dials	●
Electronic clock	●
Automatic cooking/minute timer	●
Halogen rear lights	●
<b>Accessories</b>	
Step down oven shelf	●
Flat wire shelf	●
Telescopic runners	1 set
Flat brushed baking tray	●
Roasting dish and grill rack set	●
Grill pan handles	1 set
Fat filter	●
Catalytic liners	Sides
Rotisserie set	●
Storage compartment	●
<b>Warranty</b>	1 year
<b>Available</b>	Middle East (UAE only)

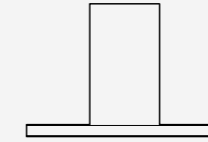
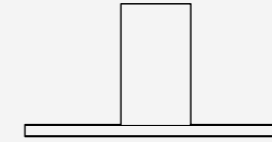

<b>Type of appliance</b>	<b>120cm VentSurface™ Island Rangehood</b>	<b>90cm VentSurface™ Wall Rangehood</b>
<b>Model no.</b>	<b>HI120MXB1</b>	<b>HC90MXB1</b>
<b>Finish</b>	<b>Stainless steel Black reflective glass</b>	<b>Stainless steel Black reflective glass</b>
<b>Dimensions</b>	H682-939 x W1198 x D648mm	H682-939 x W898 x D470mm
<b>Fan ratings</b>		
Maximum air movement	750m <sup>3</sup> /hr	750m <sup>3</sup> /hr
Maximum decibel rating	61dBA	61dBA
<b>Performance</b>		
Perimeter extraction	●	●
Fan speeds	6	6
<b>Cleaning</b>		
Dishwasher safe aluminium mesh filters	●	●
Filter cleaning alert	●	●
<b>Installation</b>		
Two piece adjustable flue with optional extensions	●	●
Ducted or recirculating options	●	●
<b>Controls</b>		
Soft touch controls	●	●
Manual and sensor modes	●	●
Timer function	●	●
Halogen lights	4 x 10W	2 x 10W
Supply voltage	220-240V	220-240V
<b>Optional accessories</b>		
Recirculating kit	●	●
Carbon filter	●	●
Aluminium filter	●	●
<b>Warranty</b>	1 year	1 year
<b>Available</b>	South East Asia/India	South East Asia/Middle East/India

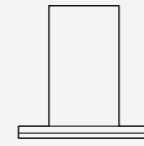
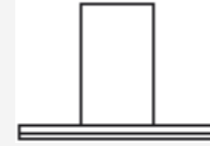
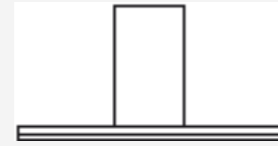

Type of appliance	120cm Wall Canopy Rangehood	90cm Wall Canopy Rangehood	60cm Wall Canopy Rangehood
<b>Model no.</b>	HC120DCXB1	HC90DCXB1	HC60DCXB1
<b>Finish</b>	Stainless steel Black glass	Stainless steel Black glass	Stainless steel Black glass
<b>Dimensions</b>	H635-1035 x W1200 x D500mm	H635-1035 x W900 x D500mm	H635-1035 x W600 x D500mm
<b>Fan ratings</b>			
Max. air movement	800m <sup>3</sup> /hr	800m <sup>3</sup> /hr	800m <sup>3</sup> /hr
Max. decibel rating	60dBA	60dBA	60dBA
<b>Performance</b>			
Centrifugal fan	●	●	●
Fan speeds	3	3	3
<b>Cleaning</b>			
Dishwasher-safe aluminium mesh filters	4	3	2
Easy-clean interior plate	●	●	●
<b>Installation</b>			
Two-piece adjustable flue with optional extensions	●	●	●
Ducted or recirculating options	●	●	●
<b>Controls</b>			
Capacitive touch controls	●	●	●
Timer function	●	●	●
Halogen lights	2 x 50W	2 x 50W	2 x 50W
Dimmable lights	●	●	●
Supply voltage	220-240V	220-240V	220-240V
<b>Optional accessories</b>			
Chimney extension	●	●	●
Ducting accessories	●	●	●
Recirculating kit	●	●	●
Charcoal filter	●	●	●
<b>Warranty</b>	1 year	1 year	1 year
<b>Available</b>	South East Asia/Middle East/India	South East Asia/Middle East/India	South East Asia/Middle East/India

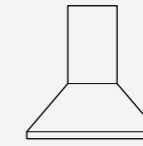
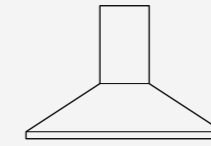

Type of appliance	90cm Wall Canopy Rangehood	60cm Wall Canopy Rangehood
<b>Model no.</b>	HC90PCHTX2	HC60PCHTX2
<b>Finish</b>	Brushed stainless steel	Brushed stainless steel
<b>Dimensions</b>	H648-1068 x W900 x D480mm	H648-1068 x W600 x D450mm
<b>Fan ratings</b>		
Maximum air movement	863M <sup>3</sup> /hr	812M <sup>3</sup> /hr
Maximum decibel rating	65dBA	65dBA
<b>Performance</b>		
Centrifugal fan	●	●
Fan speeds	3	3
<b>Cleaning</b>		
Dishwasher safe aluminium mesh filters	3	2
Easy-clean drip tray	●	●
<b>Installation</b>		
Two piece adjustable flue with optional extensions	●	●
Ducted or recirculating options	●	●
<b>Controls</b>		
Soft touch controls	●	●
Halogen lights	2 x 20W	2 x 20W
Supply voltage	220-240V	220-240V
<b>Optional accessories</b>		
Recirculating kit	●	●
Charcoal filter	●	●
Aluminium filter	●	●
<b>Warranty</b>	1 year	1 year
<b>Available</b>	South East Asia/India	South East Asia/Middle East/India





Type of appliance	90cm Splashback
Model no.	SB90X3
Finish	Stainless steel
Dimensions	H750 x W900 x D10mm



**Oven Light**

Remains lit while the oven is in use, but can also be used independently from the other cooking functions.



**Bake**

Heat is provided from the upper and lower elements. A traditional cooking mode, suitable for single shelf cooking of items like cakes, delicate items like sponges, custard tart and crème brûlée.



**Fan Bake**

The oven fan circulates hot air from upper and lower elements and distributes it around the cavity. Food browns more quickly, great for crisping pastry. Suitable for robust items like cookies, scones and muffins.



**Classic Bake**

Uses the heat from the lower element only. This is a traditional cooking mode which is suitable for recipes that were developed in older ovens. For best results, cook on only one shelf at a time. Perfect for foods that require delicate cooking and have a pastry base, like custard tarts, quiches and cheesecake or anything that does not require direct heat and browning on the top surface.



**Pastry Bake/Fan Forced with Lower Heat**

The lower heating element and fan provide outstanding cooking performance.



**Roast**

A two step programme that has been developed to help you cook delicious roasts effortlessly. This function is a combination of grill and bake, grilling your food for the first 20 minutes it then bakes at the set temperature for the rest of your cooking time. This sears the meat to keep in the juices.



**Grill**

The grill element delivers heat for fast, healthy grilling. Perfect for tender meat cuts, toasting and crisping.



**Fan Grill**

The oven fan circulates hot air from the top element for high speed grilling and produces food with a finish that is similar to a rotisserie. Food is crisp and brown on the outside while the inside remains moist and tender.



**Fan Forced**

A very flexible method of cooking. A concealed element surrounding the fan at the rear of the oven heats air which is then distributed evenly around the cavity. This is the ideal mode for multi-shelf cooking and complete oven meals.



**Defrost**

The oven fan circulates air around the oven, speeding up the defrosting process by up to 30%.



**Warm**

Use this function to keep cooked food hot and to warm plates and serving dishes.



**Warm**

Use this function to keep cooked food hot and to warm plates and serving dishes.



**Pyrolytic Self Clean**

During the self clean cycle, the oven reaches higher temperatures than it does for cooking, breaking down soil and grease deposits which can be wiped away with a damp cloth.



**Rotisserie**

A delicious way to cook meat and poultry. The slowly rotating food is basted continuously in its own juices, making it tender on the inside and well browned and full of flavour on the outside. A two step programme that has been developed to help you cook delicious roasts effortlessly. This function is a combination of grill and bake, grilling your food for the first 20 minutes it then bakes at the set temperature for the rest of your cooking time. This sears the meat to keep in the juices.

**Sabbath mode**

This setting is designed for religious faiths that observe a 'no work' requirement on the Sabbath. It is used in conjunction with the Bake function.

Note: Use all oven functions with the oven door closed.

C O O L

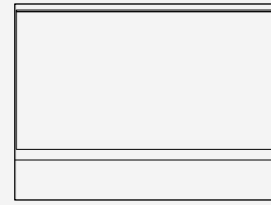

<b>Type of appliance</b>	CoolDrawer™
<b>Model no.</b>	RB90S64MKIW1
<b>Finish</b>	●
Integrated	●
EZKleen stainless steel drawer panel	● part number 840545
<b>Dimensions</b>	H640 x W855 x D557mm (excluding drawer panel, including power cord)
<b>Capacity</b>	
Total gross capacity	80 litres
<b>Energy rating</b>	
Refrigerator	4 ticks/Excellent
<b>Energy usage (kWh per year)</b>	149
<b>Modes</b>	
Chill (-0.5°C)	●
Pantry (12°C)	●
Wine (7–15°C)	●
Refrigerator (3°C)	●
Freezer (-18°C)	●
<b>Features</b>	
Touch control glass interface	●
Key lock	●
Variable temperature control	●
Fruit and vegetable drawer and pullout tray	●
Customisable storage container	●
Drawer alarm	●
<b>Warranty</b>	
Parts and labour	1 year
Sealed system parts	1 year
<b>Available</b>	South East Asia/Middle East/India

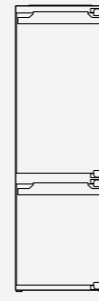

<b>Type of appliance</b>	Bottom Mount Integrated Refrigerator
<b>Model no.</b>	RB60V18
<b>Finish</b>	Integrated
<b>Dimensions (excluding handles)</b>	H1773 x W540 x D544mm
<b>Capacity (net)</b>	
Refrigerator	138 litres
Freezer	25 litres
Total	225 litres
Total gross capacity	266 litres
<b>Energy usage (kWh per year) (HK EMSD approved figures)</b>	99
<b>Performance</b>	
Frost free	●
Auto defrost	●
Fast freeze	●
Rapid cooling	●
Variable temperature drawer	●
Humidity controlled crisper bin	●
Holiday mode	●
<b>Refrigerator</b>	
Door alarm	●
Adjustable glass shelves	3
Split glass shelf	●
Fruit & vegetable bins	●
Adjustable door shelves	3
LED lighting	●
Egg trays	●
<b>Freezer</b>	
Clear plastic bins	3
<b>Warranty</b>	
Parts & labour	1 year
<b>Available</b>	South East Asia/Middle East/India

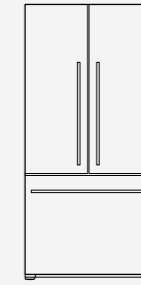
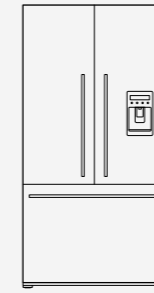

<b>Type of appliance</b>	French Door Refrigerator	French Door Refrigerator	French Door Refrigerator
<b>Model no.</b>	RF610ADUSX4	RF522ADUSX4	RF522ADX4
<b>Finish</b>	EZKleen stainless steel flat door Concealed hinge	EZKleen stainless steel flat door Concealed hinge	EZKleen stainless steel flat door Concealed hinge
<b>Dimensions (excluding handles)</b>	H1790 x W900 x D695mm	H1715 x W790 x D695mm	H1715 x W790 x D695mm
<b>Capacity (net)</b>			
Refrigerator	414 litres	337 litres	338 litres
Freezer	131 litres	103 litres	105 litres
Total	545 litres	440 litres	443 litres
Total gross capacity	614 litres	529 litres	529 litres
<b>Energy usage (kWh per year) (HK EMSD approved figures)</b>	HK EMSD N/A	486	450
<b>Performance</b>			
ActiveSmart™ technology	●	●	●
Frost free freezer	●	●	●
Adaptive defrost	●	●	●
Humidity control system	●	●	●
Sabbath mode	●	●	●
<b>Refrigerator</b>			
Water dispenser	●	●	●
Door alarm	●	●	●
Adjustable glass shelves	3	4	4
Fruit and vegetable bins	2	2	2
Stackable bottle holders	4	4	4
Adjustable door shelves	6	6	6
Covered door shelves	2	2	2
LED light	●	●	●
Deli storage bins	2		
<b>Freezer</b>			
Built-in ice maker	●	●	●
Large plastic bin	●	●	●
Small plastic bins	2	2	2
Ice bin and scoop	●	●	●
Ice tray	●	●	●
LED light	●	●	●
Door alarm	●	●	●
<b>Accessories</b>			
Water filter	Part number 836848	Part number 836848	
Stainless steel surround kit	Part number 23989	Part number 23990	Part number 23990
<b>Warranty</b>			
Parts & labour	1 year	1 year	1 year
Sealed system parts	4 years	4 years	4 years
<b>Available</b>	South East Asia/Middle East/India	South East Asia/Middle East/India	South East Asia/Middle East/India

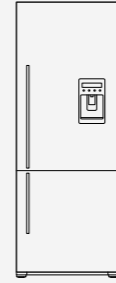
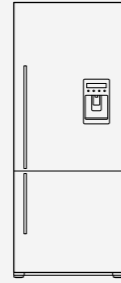
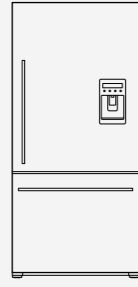

Type of appliance	Ice & Water Door Drawer Refrigerator	Ice & Water Bottom Freezer Refrigerator	Ice & Water Bottom Freezer Refrigerator
<b>Models no.</b>	RF522WDRUX4 RF522WDLUX4	E442BRXFDU4	E402BRXFDU4
<b>Finish</b>	EZKleen stainless steel flat door Concealed hinge	EZKleen stainless steel flat door Concealed hinge	EZKleen stainless steel flat door Concealed hinge
<b>Dimensions (excluding handles)</b>	H1715 x W790 x D695mm	H1715 x W680 x D695mm	H1715 x W635 x D695mm
<b>Capacity (net)</b>			
Refrigerator	103 litres	295 litres	272 litres
Freezer	342 litres	97 litres	88 litres
Total	445 litres	392 litres	360 litres
Total gross capacity	534 litres	448 litres	414 litres
<b>Energy usage (kWh per year) (HK EMSD approved figures)</b>	384	HK EMSD N/A	445
<b>Performance</b>			
ActiveSmart™ technology	●	●	●
Frost free freezer	●	●	●
Adaptive defrost	●	●	●
Humidity control system	●	●	●
Sabbath mode	●	●	●
<b>Refrigerator</b>			
Water dispenser	●	●	●
Door alarm	●	●	●
Adjustable glass shelves	4	4	4
Fruit and vegetable bins	2	2	2
Stackable bottle holders	4	2	2
Adjustable door shelves	4	4	4
Covered door shelves	2	2	2
Egg trays		2	2
LED light	●	●	●
<b>Freezer</b>			
Built-in ice maker	●	●	●
Large plastic bin	●	●	●
Small plastic bins	2	2	2
Ice bin and scoop	●	●	●
Centre roll out tray		●	●
Door alarm	●	●	●
<b>Accessories</b>			
Water filter	part number 836848	part number 836850	part number 836848
L-hand hinge	part number 23986	part number 23983	part number 23980
R-hand hinge	part number 23987	part number 23984	part number 23981
Pigeon Pair (two fridges joined)	part number 23988	part number 23985	part number 23982
Joiner kit	part number 819264	part number 819264	part number 819264
<b>Warranty</b>			
Parts & labour	1 year	1 year	1 year
<b>Available</b>	South East Asia/Middle East/India	South East Asia/Middle East/India	South East Asia/Middle East/India



Type of appliance	Door Drawer Refrigerator	Bottom Freezer Refrigerator
<b>Model no.</b>	RF522WDRX4 RF522WDLX4	E402BRXFD4
<b>Finish</b>	EZKleen stainless steel flat door Concealed hinge	EZKleen stainless steel flat door Concealed hinge
<b>Dimensions (excluding handles)</b>	H1715 x W790 x D695mm	H1715 x W635 x D695mm
<b>Capacity (net)</b>		
Refrigerator	342 litres	272 litres
Freezer	105 litres	88 litres
Total	447 litres	360 litres
Total gross capacity	534 litres	414 litres
<b>Energy usage (kWh per year) (HK EMSD approved figures)</b>	384	445
<b>Performance</b>		
ActiveSmart™ technology	●	●
Frost free freezer	●	●
Adaptive defrost	●	●
Humidity control system	●	●
Sabbath mode	●	●
<b>Refrigerator</b>		
Door alarm	●	●
Adjustable glass shelves	4	4
Fruit and vegetable bins	2	2
Stackable bottle holders	4	2
Adjustable door shelves	4	4
Covered door shelves	2	2
Egg trays		2
LED light	●	●
<b>Freezer</b>		
Large plastic bin	●	●
Small plastic bins	2	2
Ice tray	●	2
Centre roll out tray	●	●
Ice bin and scoop	●	●
Door alarm	●	●
<b>Accessories</b>		
Water filter	part number 836848	part number 836848
L-hand hinge	part number 23986	part number 23980
R-hand hinge	part number 23987	part number 23981
Pigeon Pair (two fridges joined)	part number 23988	part number 23982
Joiner kit	part number 819264	part number 819264
<b>Warranty</b>		
Parts & labour	1 year	1 year
<b>Available</b>	South East Asia/India	South East Asia/India

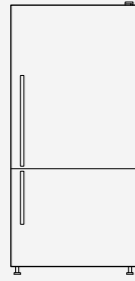

Type of appliance	Bottom Freezer Refrigerator	Bottom Freezer Refrigerator	Bottom Freezer Refrigerator
<b>Model no.</b>	<b>E522BRX4</b> E522BLX4	<b>E442BRX4</b> E442BLX4	<b>E402BRX4</b>
<b>Finish</b>	<b>EZKleen stainless steel curved door</b>	<b>EZKleen stainless steel curved door</b>	<b>EZKleen stainless steel curved door</b>
<b>Dimensions (excluding handles)</b>	H1695 x W790 x D715mm	H1695 x W680 x D715mm	H1695 x W635 x D715mm
<b>Capacity (net)</b>			
Refrigerator	352 litres	295 litres	272 litres
Freezer	121 litres	97 litres	88 litres
Total	473 litres	392 litres	360 litres
Total gross capacity	534 litres	448 litres	414 litres
<b>Energy usage (kWh per year) (HK EMSD approved figures)</b>	431	HK EMSD N/A	445
<b>Performance</b>			
ActiveSmart™ technology	●	●	●
Frost free freezer	●	●	●
Adaptive defrost	●	●	●
Humidity control system	●	●	●
Sabbath mode	●	●	●
<b>Refrigerator</b>			
Door alarm	●	●	●
Adjustable glass shelves	4	4	4
Fruit and vegetable bins	2	2	2
Stackable bottle holders	4	2	2
Adjustable door shelves	4	4	4
Covered door shelves	2	2	2
Egg trays	2	2	2
LED light	●	●	●
<b>Freezer</b>			
Large plastic bin	●	●	●
Small plastic bins	2	2	2
Ice trays	2	2	2
Centre roll out tray	●	●	●
Door alarm	●	●	●
<b>Warranty</b>			
Parts & labour	1 year	1 year	1 year
<b>Available</b>	South East Asia/India	South East Asia/India	South East Asia/India



Type of appliance	Bottom Freezer Refrigerator	Bottom Freezer Refrigerator
<b>Model no.</b>	<b>E522BRE4</b> E522BLE4	<b>E402BRE4</b>
<b>Finish</b>	<b>White curved door</b>	<b>White curved door</b>
<b>Dimensions (excluding handles)</b>	H1695 x W790 x D715mm	H1695 x W635 x D715mm
<b>Capacity (net)</b>		
Refrigerator	352 litres	272 litres
Freezer	121 litres	88 litres
Total	473 litres	360 litres
Total gross capacity	534 litres	414 litres
<b>Energy usage (kWh per year) (HK EMSD approved figures)</b>	431	445
<b>Performance</b>		
ActiveSmart™ technology	●	●
Frost free freezer	●	●
Adaptive defrost	●	●
Humidity control system	●	●
Sabbath mode	●	●
<b>Refrigerator</b>		
Door alarm	●	●
Adjustable glass shelves	4	4
Fruit and vegetable bins	2	2
Adjustable door shelves	4	4
Covered door shelves	2	2
Egg trays	2	2
LED light	●	●
<b>Freezer</b>		
Large plastic bin	●	●
Small plastic bins	2	2
Ice trays	2	2
Centre roll out tray	●	●
Door alarm	●	●
<b>Warranty</b>		
Parts & labour	1 year	1 year
<b>Available</b>	South East Asia	South East Asia



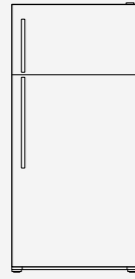

Type of appliance	Top Freezer Refrigerator	Top Freezer Refrigerator
Model no.	E521TRX3	E411TRX2
	E521TLX3	
Finish	EZKleen stainless steel curved door	EZKleen stainless steel curved door
Dimensions (excluding handles)	H1695 x W790 x D715mm	H1695 x W635 x D715mm
<b>Capacity (net)</b>		
Refrigerator	390 litres	302 litres
Freezer	97 litres	75 litres
Total	487 litres	377 litres
Total gross capacity	520 litres	404 litres
<b>Energy usage (kWh per year) (HK EMSD approved figures)</b>	369	454
<b>Performance</b>		
ActiveSmart™ technology	●	●
Frost free freezer	●	●
Adaptive defrost	●	●
Humidity control system	●	●
Sabbath mode	●	●
<b>Refrigerator</b>		
Door alarm	●	●
Adjustable glass shelves	4	4
Fruit and vegetable bins	1 (full width)	1 (full width)
Stackable bottle holders	4	2
Adjustable door shelves	4	4
Covered door shelves	2	2
Egg trays	2	2
LED light	●	●
<b>Freezer</b>		
Glass shelves	●	●
Door shelves	3	2
Ice trays	2	2
Door alarm	●	●
<b>Warranty</b>		
Parts & labour	1 year	1 year
<b>Available</b>	South East Asia/Middle East/India	South East Asia

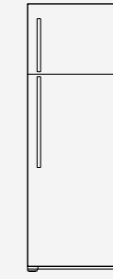
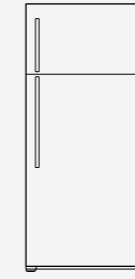

Type of appliance	Top Freezer Refrigerator	Top Freezer Refrigerator
Model no.	E521TRE3	E411TRE2
	E521TLE3	
Finish	White curved door	White curved door
Dimensions (excluding handles)	H1695 x W790 x D715mm	H1695 x W635 x D715mm
<b>Capacity (net)</b>		
Refrigerator	390 litres	302 litres
Freezer	97 litres	75 litres
Total	487 litres	377 litres
Total gross capacity	520 litres	404 litres
<b>Energy usage (kWh per year) (HK EMSD approved figures)</b>	369	454
<b>Performance</b>		
ActiveSmart™ technology	●	●
Frost free freezer	●	●
Adaptive defrost	●	●
Humidity control system	●	●
Sabbath mode	●	●
<b>Refrigerator</b>		
Door alarm	●	●
Adjustable glass shelves	4	4
Fruit and vegetable bins	1 (full width)	1 (full width)
Stackable bottle holders	4	2
Adjustable door shelves	4	4
Covered door shelves	2	2
Egg trays	2	2
LED light	●	●
<b>Freezer</b>		
Glass shelves	●	●
Door shelves	3	2
Ice trays	2	2
Door alarm	●	●
<b>Warranty</b>		
Parts & labour	1 year	1 year
<b>Available</b>	South East Asia	South East Asia/India

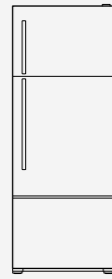

Type of appliance	Top Freezer Refrigerator	Top Freezer Refrigerator
Model no.	E415HRX2	E415HRE2
Finish	EZKleen stainless steel curved door	White curved door
Dimensions (excluding handles)	H1695 x W635 x D715mm	H1695 x W635 x D715mm
Capacity (net)		
Refrigerator	292 litres	292 litres
Freezer	75 litres	75 litres
Total	367 litres	367 litres
Total gross capacity	399 litres	399 litres
Energy usage (kWh per year) (HK EMSD approved figures)	569	569
Performance		
ActiveSmart™ technology	●	●
Frost free freezer	●	●
Adaptive defrost	●	●
Humidity control system	●	●
Sabbath mode	●	●
Refrigerator		
Door alarm	●	●
Adjustable glass shelves	3	3
Fruit and vegetable bins	●	●
Stackable bottle holders	2	2
Adjustable door shelves	3	3
Covered door shelves	2	2
Egg trays	2	2
LED light	●	●
Freezer		
Glass shelves	●	●
Door shelves	2	2
Ice trays	2	2
Door alarm	●	●
Warranty		
Parts & labour	1 year	1 year
Available	South East Asia	South East Asia

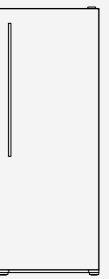

Type of appliance	Vertical Refrigerator
Models available	E450RXFD E450LXFD
Finish	EZKleen stainless steel flat door
Dimensions (excluding handles)	H1695 x W635 x D695mm
Capacity (net)	
Refrigerator	424 litres
Total	424 litres
Total gross capacity	447 litres
Energy usage (kWh per year)	186
Performance	
Air circulation fan	●
Adaptive defrost	●
Humidity control lid	●
Refrigerator	
Door alarm	●
Adjustable glass shelves	5
Crisper bin (full width)	●
Adjustable half width door shelves	4
Adjustable full width door shelves	3
Covered door shelves	2
Egg trays	2
Halogen light	●
Warranty	
Parts & labour	1 year
Available	South East Asia/India/Middle East

Type of appliance	Vertical Freezer
Model no.	E388RXFD E388LXFD
Finish	EZKleen stainless steel flat door
Dimensions (excluding handles)	H1695 x W635 x D695mm
Capacity (net)	
Freezer	288 litres
Total	288 litres
Total gross capacity	387 litres
Energy usage (kWh per year) (HK EMSD approved figures)	637
Performance	
Air circulation fan	●
Frost free freezer	●
Adaptive defrost	●
Freezer	
Door alarm	●
Freezer baskets	6
Ice trays	2
Warranty	
Parts & labour	1 year
Available	South East Asia/India/Middle East

**CoolDrawer™**

Model no:  
**RB90S64MKIW1**

Dimensions	mm
Ⓐ Overall height of product	640
Ⓚ Overall width of product	855
Ⓒ Overall depth of product	557
Ⓞ Height of product front	476*
Ⓛ Width of product front	896*
Ⓟ Depth of product front (excludes handle)	18*

\*Optional EZKleen Stainless Steel drawer panel, alternatively door and false panel to be manufactured and fitted by cabinetmaker.

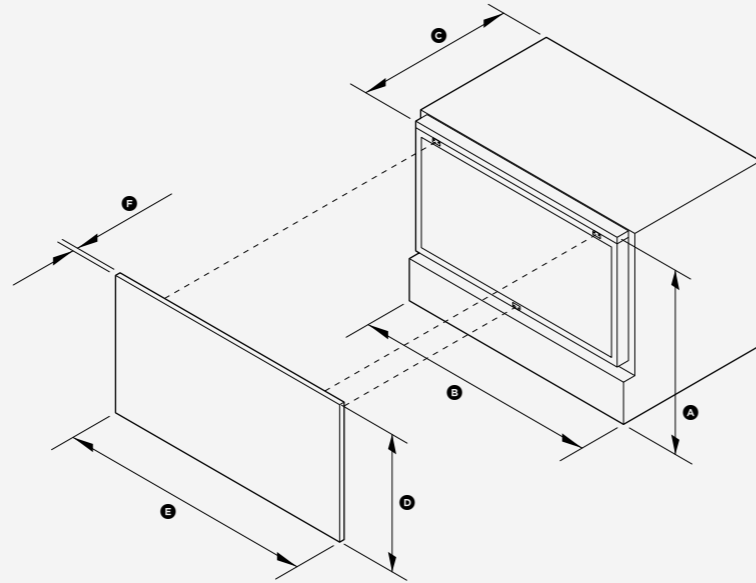

**Bottom Mount Integrated Refrigerator**

Model no:  
**RB60V18**

Dimensions	mm
Ⓐ Overall height of product	1773
Ⓚ Overall width of product	555
Ⓒ Overall depth of product (includes condenser and door brackets)	540*

\* Does not include door panels to be manufactured and fitted by cabinetmaker.

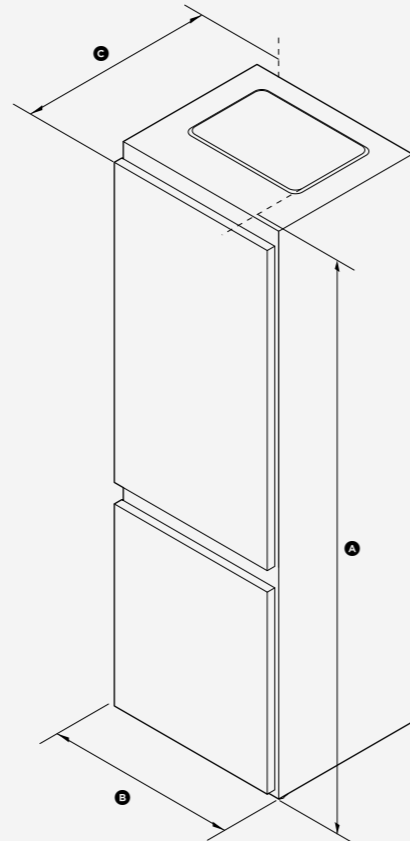

**French Door Refrigerator (Flat door)**

Model no:  
**RF610ADUSX4 (Ice & Water)**

Dimensions	mm
Ⓐ Overall height of product	1790
Ⓚ Overall width of product	900
Ⓒ Overall depth of product (excludes handle and evaporator)	695

**Cabinetry Dimensions**

Ⓞ Inside height of cavity	1810
---------------------------	------

**Flush with refrigerator chassis**

Ⓛ Inside width	940
Ⓟ Inside depth	620

**Flush with refrigerator door**

Ⓞ Inside width	1170
Ⓢ Inside depth flush to flat door	695

**Flush with refrigerator door - 90° rotation**

Ⓣ Inside width	1125
Ⓤ Inside depth flush to flat door	695

**Minimum Clearances**

Ⓧ Side clearance	20
Ⓦ Side clearance - hinge side flush with door - full rotation	135
Ⓨ Side clearance - hinge side flush with door - 90° rotation	90
Ⓩ Rear clearance (including evaporator tray)	30
ⓐ Vent (above refrigerator cabinet or around top of cupboard)	50
ⓑ Door clearance - hinge side flush with chassis - full rotation	365
ⓓ Door clearance - hinge side flush with door - full rotation	250

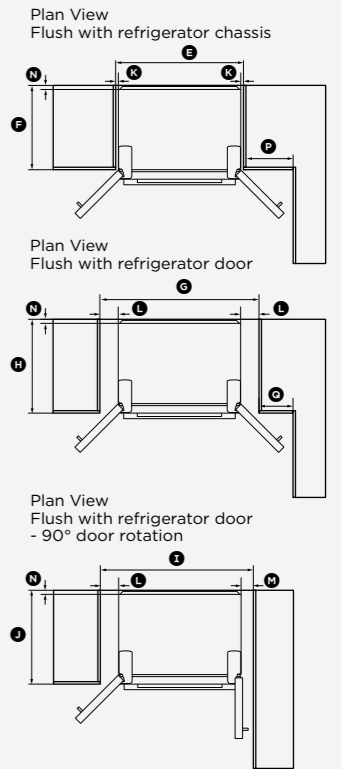
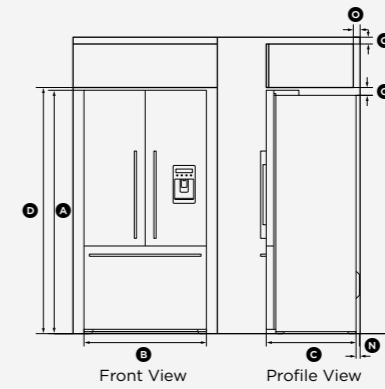

**French Door Refrigerator (Flat door)**

Model no:  
**RF522ADUSX4 (Ice & Water)**  
**RF522ADX4**

Dimensions	mm
Ⓐ Overall height of product	1715
Ⓚ Overall width of product	790
Ⓒ Overall depth of product (excludes handle and evaporator)	695

**Cabinetry Dimensions**

Ⓞ Inside height of cavity	1735
---------------------------	------

**Flush with refrigerator chassis**

Ⓛ Inside width	830
Ⓟ Inside depth	620

**Flush with refrigerator door**

Ⓞ Inside width	1060
Ⓢ Inside depth flush to flat door	695

**Flush with refrigerator door - 90° rotation**

Ⓣ Inside width	1015
Ⓤ Inside depth flush to flat door	695

**Minimum Clearances**

Ⓧ Side clearance	20
Ⓦ Side clearance - hinge side flush with door - full rotation	135
Ⓨ Side clearance - hinge side flush with door - 90° rotation	90
Ⓩ Rear clearance (including evaporator tray)	30
ⓐ Vent (above refrigerator cabinet or around top of cupboard)	50
ⓑ Door clearance - hinge side flush with chassis - full rotation	325
ⓓ Door clearance - hinge side flush with door - full rotation	210

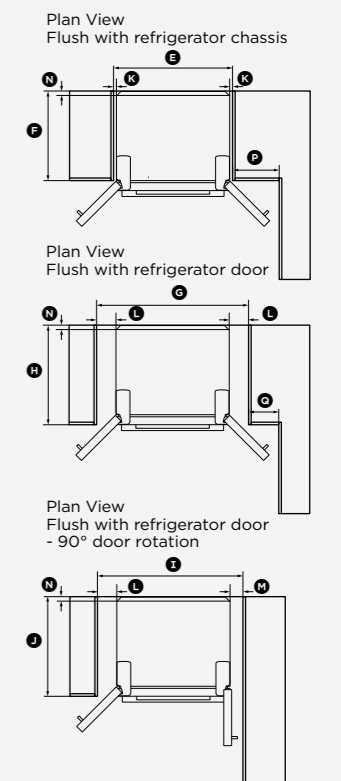
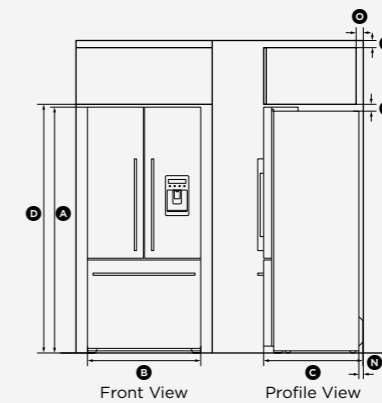

**Door Drawer Refrigerator (Flat door)**

Model no:  
**RF522WDRUX4, RF522WDLUX4 (Ice & Water)**  
**RF522WDRX4, RF522WDLX4**

Dimensions	mm
Ⓐ Overall height of product	1715
Ⓑ Overall width of product	790
Ⓒ Overall depth of product (excludes handle and evaporator)	695
<b>Cabinetry Dimensions</b>	
ⓐ Inside height of cavity	1735
<b>Flush with refrigerator chassis</b>	
ⓔ Inside width	830
ⓕ Inside depth	620
<b>Flush with refrigerator door</b>	
ⓖ Inside width	945
ⓗ Inside depth flush to flat door	695
<b>Flush with refrigerator door - 90° rotation</b>	
ⓙ Inside width	900
ⓚ Inside depth flush to flat door	695
<b>Minimum Clearances</b>	
Ⓧ Side clearance	20
Ⓛ Side clearance -hinge side flush with door -full rotation	135
Ⓜ Side clearance -hinge side flush with door -90° rotation	90
Ⓨ Rear clearance (including evaporator tray)	30
Ⓩ Vent (above refrigerator cabinet or around top of cupboard)	50
ⓐ Door clearance -hinge side flush with chassis -full rotation	645
ⓑ Door clearance -hinge side flush with door -full rotation	530

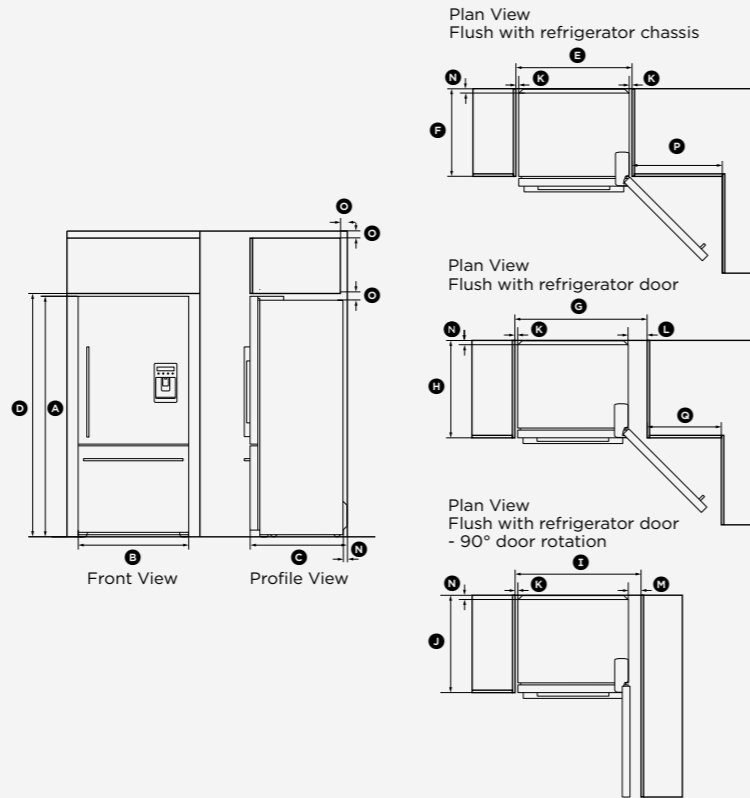

**Bottom Freezer Refrigerator (Flat door)**

Model no:  
**E402BRXFDU4 (Ice & Water)**

Dimensions	mm
Ⓐ Overall height of product	1715
Ⓑ Overall width of product	635
Ⓒ Overall depth of product (excludes handle, includes evaporator)	695
<b>Cabinetry dimensions</b>	
ⓐ Inside height of cavity	1735
<b>Flush with refrigerator chassis</b>	
ⓔ Inside width	675
ⓕ Inside depth	620
<b>Flush with refrigerator door</b>	
ⓖ Inside width	790
ⓗ Inside depth flush to flat door	695
<b>Flush with refrigerator door - 90° rotation</b>	
ⓙ Inside width	745
ⓚ Inside depth flush to flat door	695
<b>Minimum clearances</b>	
Ⓧ Side clearance	20
Ⓛ Side clearance -hinge side flush with door -full rotation	135
Ⓜ Side clearance -hinge side flush with door -90° rotation	90
Ⓨ Rear clearance (including evaporator tray)	30
Ⓩ Vent (above refrigerator cabinet or around top of cupboard)	50
ⓐ Door clearance -hinge side flush with chassis -full rotation	520
ⓑ Door clearance -hinge side flush with door -full rotation	405

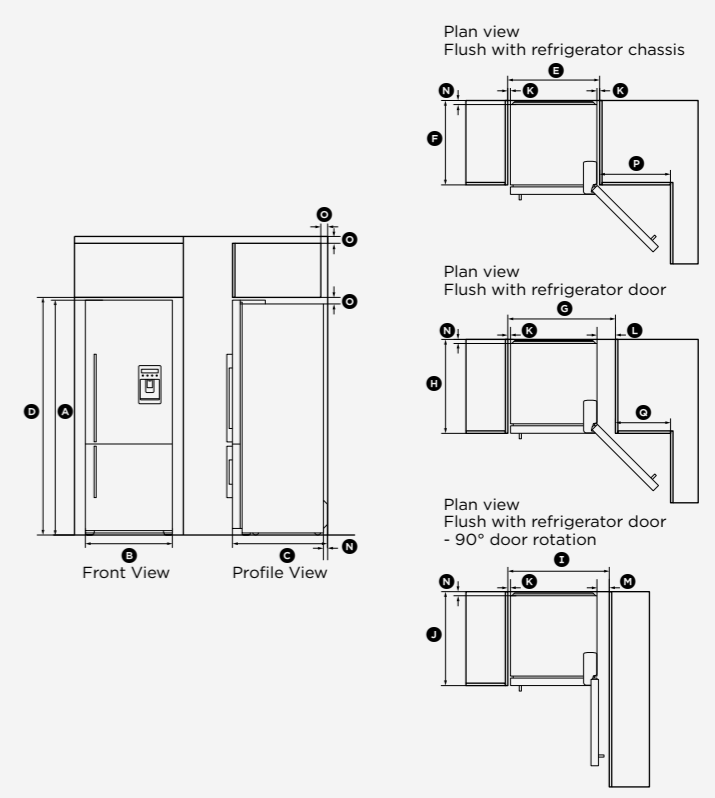

**Bottom Freezer Refrigerator (Flat door)**

Model no:  
**E442BRXFDU4**

Dimensions	mm
Ⓐ Overall height of product	1715
Ⓑ Overall width of product	680
Ⓒ Overall depth of product (excludes handle, includes evaporator)	695
<b>Cabinetry Dimensions</b>	
ⓐ Inside height of cavity	1735
<b>Flush with refrigerator chassis</b>	
ⓔ Inside width	720
ⓕ Inside depth	620
<b>Flush with refrigerator door</b>	
ⓖ Inside width	835
ⓗ Inside depth flush to flat door	695
<b>Flush with refrigerator door - 90° rotation</b>	
ⓙ Inside width	790
ⓚ Inside depth flush to flat door	695
<b>Minimum Clearances</b>	
Ⓧ Side clearance	20
Ⓛ Side clearance -hinge side flush with door -full rotation	135
Ⓜ Side clearance -hinge side flush with door -90° rotation	90
Ⓨ Rear clearance (including evaporator tray)	30
Ⓩ Vent (above refrigerator cabinet or around top of cupboard)	50
ⓐ Door clearance -hinge side flush with chassis -full rotation	555
ⓑ Door clearance -hinge side flush with door -full rotation	440

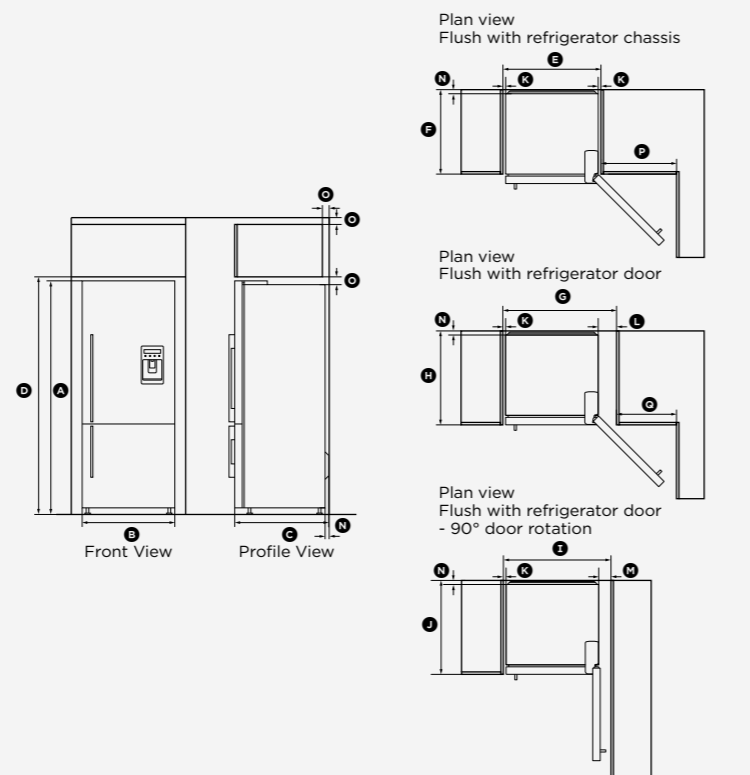

**Bottom Freezer Refrigerator (Flat door)**

Model no:  
**E402BRXFDU4**

Dimensions	mm
Ⓐ Overall height of product	1715
Ⓑ Overall width of product	635
Ⓒ Overall depth of product (excludes handle, includes evaporator)	695
<b>Cabinetry dimensions</b>	
ⓐ Inside height of cavity	1735
<b>Flush with refrigerator chassis</b>	
ⓔ Inside width	675
ⓕ Inside depth	620
<b>Flush with refrigerator door</b>	
ⓖ Inside width	790
ⓗ Inside depth flush to flat door	695
<b>Flush with refrigerator door - 90° rotation</b>	
ⓙ Inside width	745
ⓚ Inside depth flush to flat door	695
<b>Minimum clearances</b>	
Ⓧ Side clearance	20
Ⓛ Side clearance -hinge side flush with door -full rotation	135
Ⓜ Side clearance -hinge side flush with door -90° rotation	90
Ⓨ Rear clearance (including evaporator tray)	30
Ⓩ Vent (above refrigerator cabinet or around top of cupboard)	50
ⓐ Door clearance -hinge side flush with chassis -full rotation	520
ⓑ Door clearance -hinge side flush with door -full rotation	405

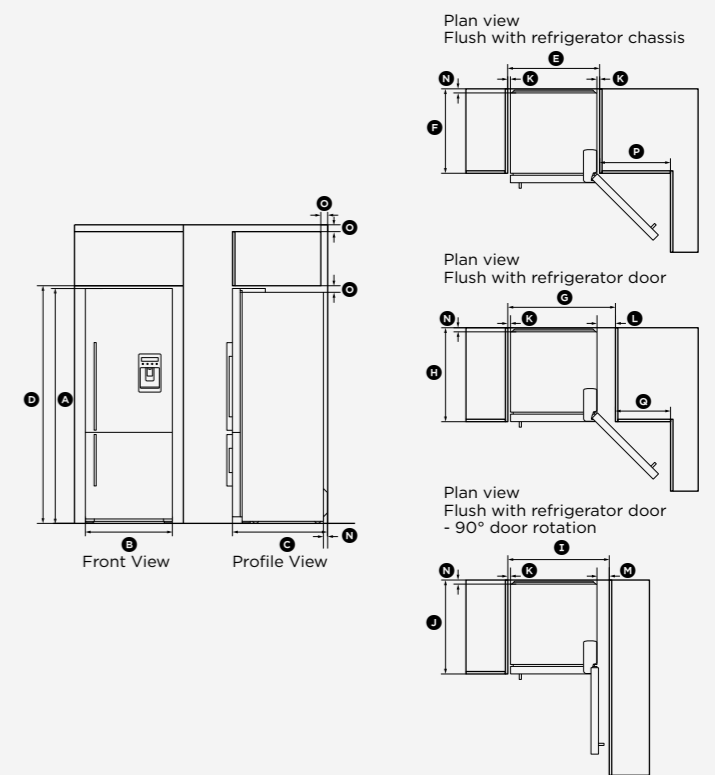

**Bottom Freezer Refrigerator** (Curved door)

Model no:  
E522BRX4, E522BLX4, E522BRE4, E522BLE4

Dimensions	mm
Ⓐ Overall height of product	1695
Ⓑ Overall width of product	790
Ⓒ Overall depth of product (excludes handle, includes evaporator)	715
<b>Cabinetry Dimensions</b>	
ⓐ Inside height of cavity	1735
<b>Flush with refrigerator chassis</b>	
ⓔ Inside width	830
ⓕ Inside depth	620
<b>Flush with refrigerator door</b>	
ⓖ Inside width	945
ⓗ Inside depth flush to curved door	680
<b>Flush with refrigerator door - 90° rotation</b>	
ⓓ Inside width	900
ⓓ Inside depth flush to curved door	680
<b>Minimum Clearances</b>	
Ⓧ Side clearance	20
Ⓛ Side clearance-hinge side flush with door-full rotation	135
Ⓜ Side clearance-hinge side flush with door-90° rotation	90
Ⓨ Rear clearance (including evaporator tray)	30
Ⓩ Vent (above refrigerator cabinet or around top of cupboard)	50
Ⓟ Door clearance-hinge side flush with chassis-full rotation	645
Ⓟ Door clearance-hinge side flush with door-full rotation	530

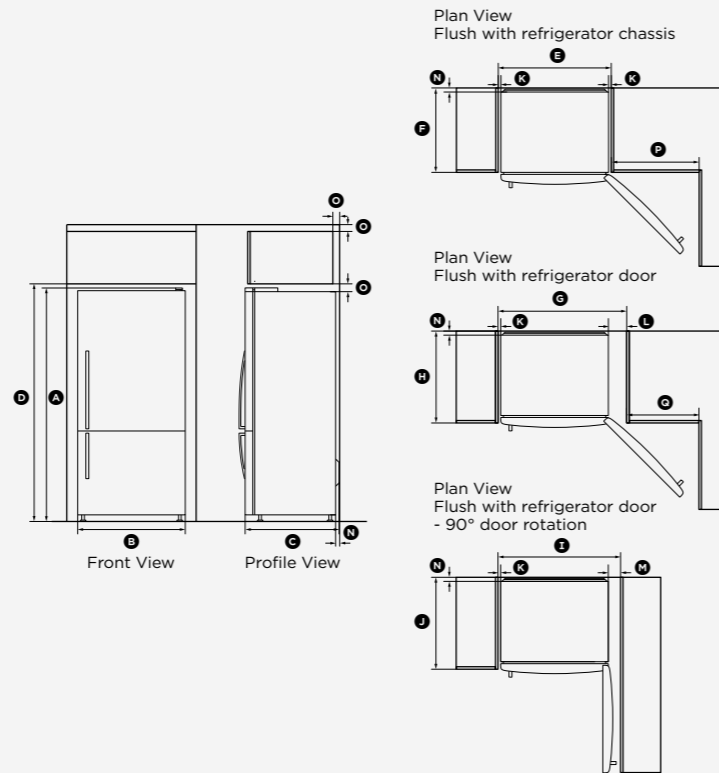

**Bottom Freezer Refrigerator** (Curved door)

Model no:  
E402BRX4, E402BRE4

Dimensions	mm
Ⓐ Overall height of product	1695
Ⓑ Overall width of product	635
Ⓒ Overall depth of product (excludes handle, includes evaporator)	715
<b>Cabinetry Dimensions</b>	
ⓐ Inside height of cavity	1735
<b>Flush with refrigerator chassis</b>	
ⓔ Inside width	675
ⓕ Inside depth	620
<b>Flush with refrigerator door</b>	
ⓖ Inside width	790
ⓗ Inside depth flush to curved door	680
<b>Flush with refrigerator door - 90° rotation</b>	
ⓓ Inside width	745
ⓓ Inside depth flush to curved door	680
<b>Minimum Clearances</b>	
Ⓧ Side clearance	20
Ⓛ Side clearance-hinge side flush with door-full rotation	135
Ⓜ Side clearance-hinge side flush with door-90° rotation	90
Ⓨ Rear clearance (including evaporator tray)	30
Ⓩ Vent (above refrigerator cabinet or around top of cupboard)	50
Ⓟ Door clearance-hinge side flush with chassis-full rotation	520
Ⓟ Door clearance-hinge side flush with door-full rotation	405

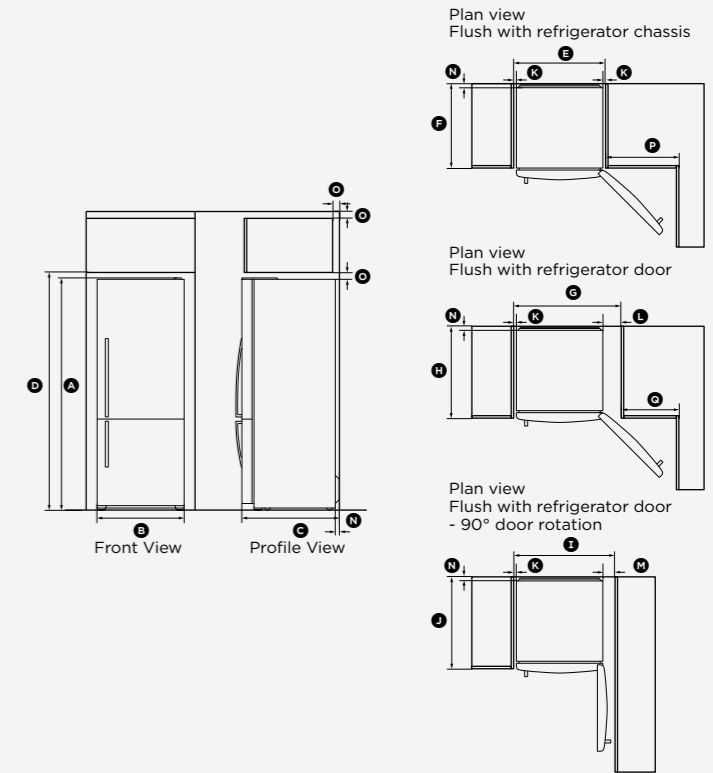

**Bottom Freezer Refrigerator** (Curved door)

Model no:  
E442BRX4, E442BLX4

Dimensions	mm
Ⓐ Overall height of product	1695
Ⓑ Overall width of product	680
Ⓒ Overall depth of product (excludes handle, includes evaporator)	715
<b>Cabinetry Dimensions</b>	
ⓐ Inside height of cavity	1735
<b>Flush with refrigerator chassis</b>	
ⓔ Inside width	720
ⓕ Inside depth	620
<b>Flush with refrigerator door</b>	
ⓖ Inside width	835
ⓗ Inside depth flush to curved door	680
<b>Flush with refrigerator door - 90° rotation</b>	
ⓓ Inside width	790
ⓓ Inside depth flush to curved door	680
<b>Minimum Clearances</b>	
Ⓧ Side clearance	20
Ⓛ Side clearance-hinge side flush with door-full rotation	135
Ⓜ Side clearance-hinge side flush with door-90° rotation	90
Ⓨ Rear clearance (including evaporator tray)	30
Ⓩ Vent (above refrigerator cabinet or around top of cupboard)	50
Ⓟ Door clearance-hinge side flush with chassis-full rotation	555
Ⓟ Door clearance-hinge side flush with door-full rotation	440

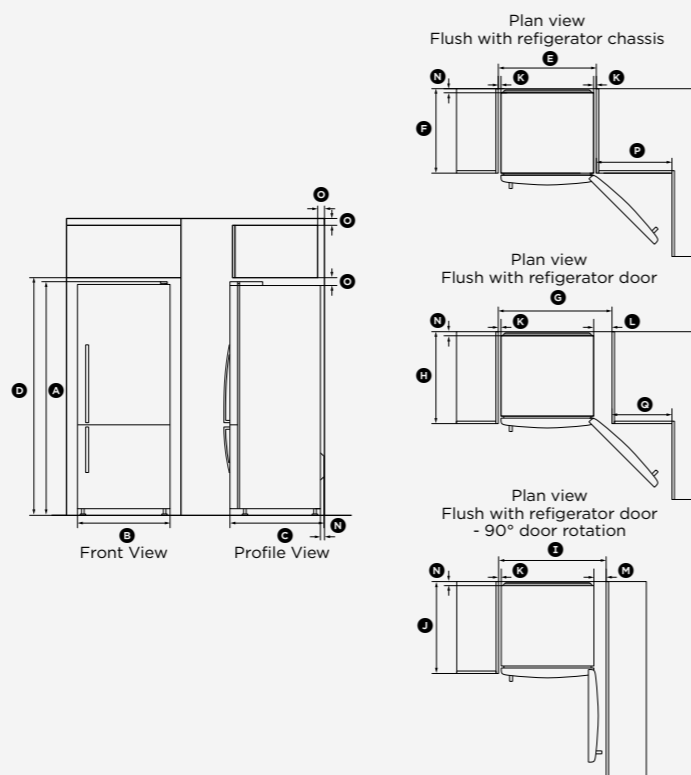

**Top Freezer Refrigerator** (Curved door)

Model no:  
E521TRX3, E521TLX3, E521TRE3, E521TLE3

Dimensions	mm
Ⓐ Overall height of product	1695
Ⓑ Overall width of product	790
Ⓒ Overall depth of product (excludes handle, includes evaporator)	715
<b>Cabinetry Dimensions</b>	
ⓐ Inside height of cavity	1735
<b>Flush with refrigerator chassis</b>	
ⓔ Inside width	830
ⓕ Inside depth	620
<b>Flush with refrigerator door</b>	
ⓖ Inside width	945
ⓗ Inside depth flush to curved door	680
<b>Flush with refrigerator door - 90° rotation</b>	
ⓓ Inside width	900
ⓓ Inside depth flush to curved door	680
<b>Minimum Clearances</b>	
Ⓧ Side clearance	20
Ⓛ Side clearance-hinge side flush with door-full rotation	135
Ⓜ Side clearance-hinge side flush with door-90° rotation	90
Ⓨ Rear clearance (including evaporator tray)	30
Ⓩ Vent (above refrigerator cabinet or around top of cupboard)	50
Ⓟ Door clearance-hinge side flush with chassis-full rotation	645
Ⓟ Door clearance-hinge side flush with door-full rotation	530

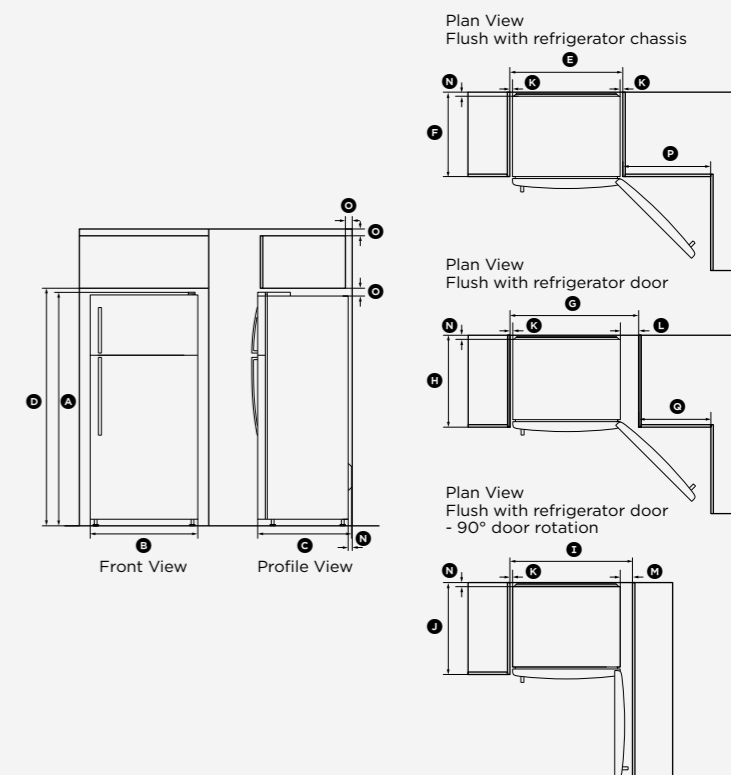



**Top Freezer Refrigerator** (Curved door)

Model no:  
**E411TRX2, E411TRE2**

Dimensions	mm
Ⓐ Overall height of product	1695
Ⓑ Overall width of product	635
Ⓒ Overall depth of product (excludes handle, includes evaporator)	715
<b>Cabinetry dimensions</b>	
Ⓓ Inside height of cavity	1735
<b>Flush with refrigerator chassis</b>	
Ⓔ Inside width	675
Ⓕ Inside depth	620
<b>Flush with refrigerator door</b>	
Ⓖ Inside width	790
Ⓜ Inside depth flush to curved door	680
<b>Flush with refrigerator door - 90° rotation</b>	
Ⓣ Inside width	745
Ⓟ Inside depth flush to curved door	680
<b>Minimum clearances</b>	
Ⓝ Side clearance	20
Ⓛ Side clearance-hinge side flush with door-full rotation	135
Ⓢ Side clearance-hinge side flush with door-90° rotation	90
Ⓝ Rear clearance (including evaporator tray)	30
Ⓞ Vent (above refrigerator cabinet or around top of cupboard)	50
Ⓟ Door clearance-hinge side flush with chassis-full rotation	520
Ⓞ Door clearance-hinge side flush with door-full rotation	405

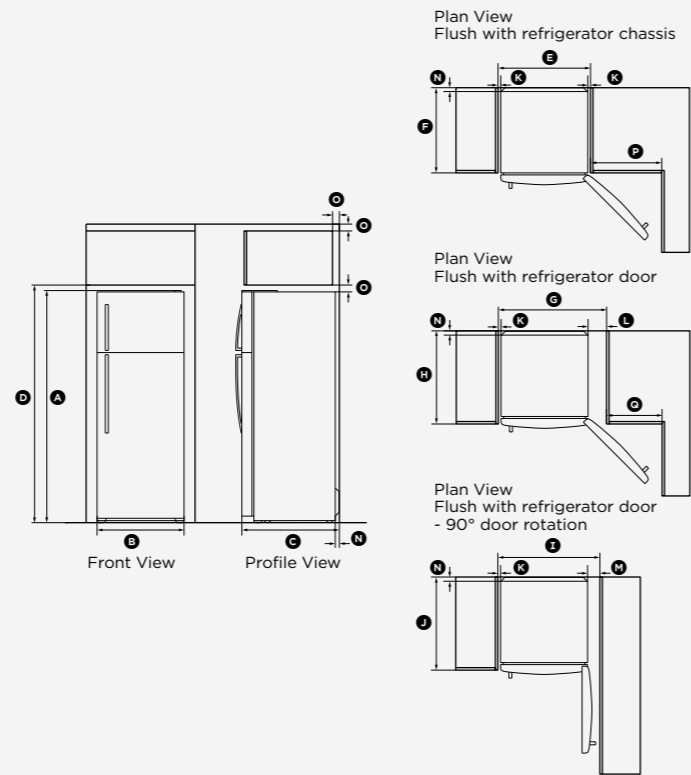

**Vertical Freezer** (Flat door)

Model no:  
**E388RXFD, E388LXFD**

Dimensions	mm
Ⓐ Overall height of product	1695
Ⓑ Overall width of product	635
Ⓒ Overall depth of product (excludes handle, includes evaporator)	695
<b>Cabinetry Dimensions</b>	
Ⓓ Inside height of cavity	1735
<b>Flush with refrigerator chassis</b>	
Ⓔ Inside width	675
Ⓕ Inside depth	620
<b>Flush with refrigerator door</b>	
Ⓖ Inside width	790
Ⓜ Inside depth flush to curved door	695
<b>Flush with refrigerator door - 90° rotation</b>	
Ⓣ Inside width	745
Ⓟ Inside depth flush to curved door	695
<b>Minimum Clearances</b>	
Ⓝ Side clearance	20
Ⓛ Side clearance-hinge side flush with door-full rotation	135
Ⓢ Side clearance-hinge side flush with door-90° rotation	90
Ⓝ Rear clearance (including evaporator tray)	30
Ⓞ Vent (above refrigerator cabinet or around top of cupboard)	50
Ⓟ Door clearance-hinge side flush with chassis-full rotation	520
Ⓞ Door clearance-hinge side flush with door-full rotation	405

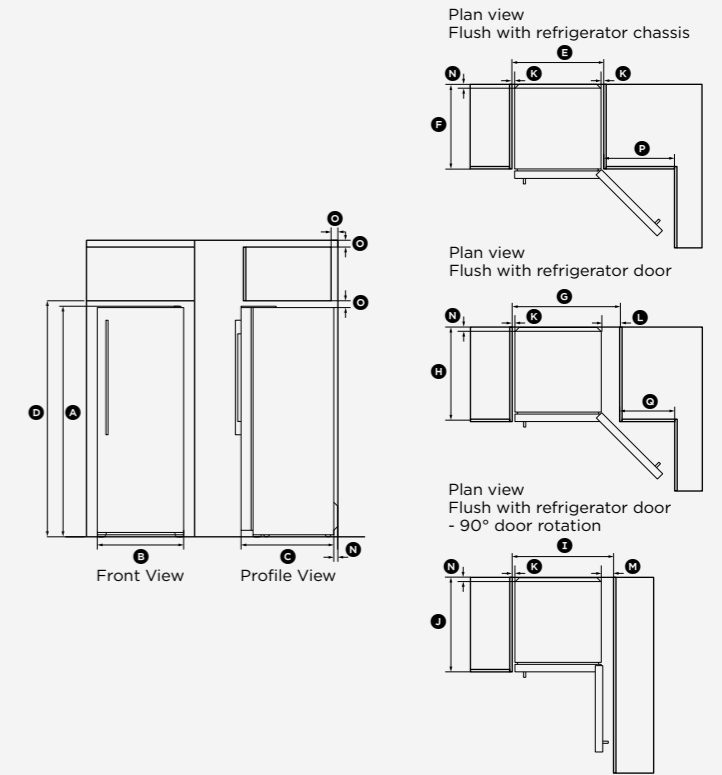

**Vertical Refrigerator** (Flat door)

Model no:  
**E450RXFD, E450LXFD**

Dimensions	mm
Ⓐ Overall height of product	1695
Ⓑ Overall width of product	635
Ⓒ Overall depth of product (excludes handle, includes evaporator)	695
<b>Cabinetry Dimensions</b>	
Ⓓ Inside height of cavity	1735
<b>Flush with refrigerator chassis</b>	
Ⓔ Inside width	675
Ⓕ Inside depth	620
<b>Flush with refrigerator door</b>	
Ⓖ Inside width	790
Ⓜ Inside depth flush to curved door	695
<b>Flush with refrigerator door - 90° rotation</b>	
Ⓣ Inside width	745
Ⓟ Inside depth flush to curved door	695
<b>Minimum Clearances</b>	
Ⓝ Side clearance	20
Ⓛ Side clearance-hinge side flush with door-full rotation	135
Ⓢ Side clearance-hinge side flush with door-90° rotation	90
Ⓝ Rear clearance (including evaporator tray)	30
Ⓞ Vent (above refrigerator cabinet or around top of cupboard)	50
Ⓟ Door clearance-hinge side flush with chassis-full rotation	520
Ⓞ Door clearance-hinge side flush with door-full rotation	405

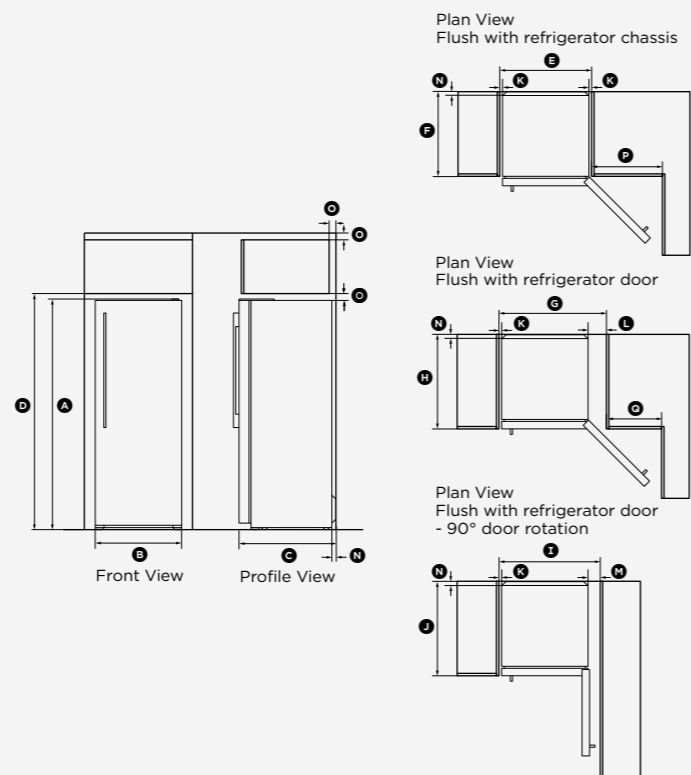

CLEAN

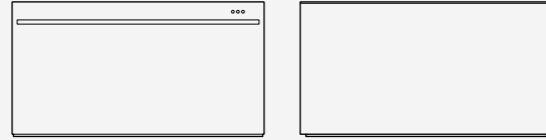

Type of appliance	DishDrawer™ Wide Dishwasher	DishDrawer™ Wide Dishwasher
<b>Model no.</b>	<b>DD90SDFTX2</b>	<b>DD90STI2</b>
<b>Finish</b>	<b>EZKleen stainless steel flat door</b>	<b>Integrated</b> <b>(apply your own cabinetry façade)</b>
<b>Dimensions (excluding handles)</b>	H478 x W895 x D571mm	H478 x W855 x D569-573mm
<b>Energy rating</b>	3 star	3 star
<b>Energy usage</b>	197kWh per year	210kWh per year
<b>Water rating</b>	4 star (WELS)	4 star (WELS)
<b>Water usage</b>	9.4 litres per wash cycle	9.4 litres per wash cycle
<b>Performance</b>		
SmartDrive™ technology	●	●
Water level sensing	●	●
Flow through detergent dispenser	●	●
Quiet operation	●	●
Fan assisted drying	●	●
<b>Capacity and loading</b>		
Place settings per drawer	9	9
Flexible racking system	●	●
Fold down tines	●	●
Adjustable racks and cup racks	●	●
Accommodates long stemmed wine glasses	●	●
Accommodates plates up to	315mm	315mm
<b>Wash programs</b>		
Nine wash programs	●	●
Eco options	●	●
Permanent memory of the last cycle used	●	●
<b>Safety</b>		
Three stage total flood protection	●	●
<b>Controls</b>		
Wireless remote		●
Concealed control panels with single touch programming	●	●
Key lock	●	
Child lock	●	●
End of cycle beeps	●	●
One button start	●	●
Energy saving delay start option up to 12 hours	●	●
Rinse aid indicator light and lens	●	●
Electronic fault/Diagnostic indicator	●	●
<b>AMP draw</b>	10A	10A
<b>Accessories</b>		
Cutlery basket	●	●
Knife clip	2	2
<b>Warranty</b>	1 year	1 year
<b>Available</b>	South East Asia	South East Asia

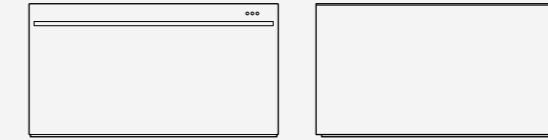

Type of appliance	DishDrawer™ Wide Dishwasher	DishDrawer™ Wide Dishwasher
<b>Model no.</b>	<b>DD90SDFHTX2</b>	<b>DD90SHTI2</b>
<b>Finish</b>	<b>EZKleen stainless steel flat door</b>	<b>Integrated</b> <b>(apply your own cabinetry façade)</b>
<b>Dimensions (excluding handles)</b>	H478 x W895 x D571mm	H478 x W855 x D569-573mm
<b>Energy rating</b>	A	A
<b>Noise level</b>	49dBA	49dBA
<b>Performance</b>		
SmartDrive™ technology	●	●
Water level sensing	●	●
Flow through detergent dispenser	●	●
Quiet operation	●	●
Fan assisted drying	●	●
Built-in water softener	●	●
<b>Capacity and loading</b>		
Place settings per drawer	9	9
Flexible racking system	●	●
Fold down tines	●	●
Adjustable racks and cup racks	●	●
Accommodates long stemmed glasses	●	●
Accommodates plates up to	315mm	315mm
<b>Wash programs</b>		
Nine wash programs	●	●
Eco options	●	●
Permanent memory of the last cycle used	●	●
<b>Safety</b>		
Three stage total flood protection	●	●
<b>Controls</b>		
Concealed control panels with single touch programming	●	●
Key lock	●	●
Child safety lock	●	●
End of cycle beeps	●	●
One button start	●	●
Energy saving delay start option of up to 12 hours	●	●
Rinse aid indicator light and lens	●	●
Electronic fault/Diagnostic indicator	●	●
<b>AMP draw</b>	10A	10A
<b>Accessories</b>		
Cutlery basket	●	●
Knife clip	2	2
Satin chrome badge		●
<b>Warranty</b>	1 year	1 year
<b>Available</b>	Middle East/India	Middle East/India



<b>Type of appliance</b>	DishDrawer™ Tall Dishwasher
<b>Model no.</b>	DD60SDFTX7
<b>Finish</b>	EZKleen stainless steel flat door
<b>Dimensions (excluding handles)</b>	H478 x W599 x D571mm
<b>Energy rating</b>	3.5 star
<b>Energy usage</b>	134kWh per year
<b>Water rating</b>	4.5 star (WELS)
<b>Water usage</b>	6.7 litres per wash cycle
<b>Performance</b>	
SmartDrive™ technology	●
Water level sensing	●
Flow through detergent dispenser	●
Quiet operation	●
Fan assisted drying	●
<b>Capacity and loading</b>	
Place settings per drawer	7
Flexible racking system	●
Fold down and pitch adjustable tines	●
Adjustable racks and cup racks	●
Accommodates long stemmed glasses	●
Accommodates plates up to	330mm
<b>Wash programs</b>	
Nine wash programs	●
Eco options	●
Permanent memory of the last cycle used	●
<b>Safety</b>	
Three stage total flood protection	●
<b>Controls</b>	
Wireless remote	
Concealed control panels with single touch programming	●
Key lock	●
Child lock	●
End of cycle beeps	●
One button start	●
Energy saving delay start option up to 12 hours	●
Rinse aid indicator light and lens	●
Electronic fault/Diagnostic indicator	●
<b>AMP draw</b>	4.5A
<b>Accessories</b>	
Cutlery basket	●
Knife clip	2
<b>Warranty</b>	1 year
<b>Available</b>	South East Asia

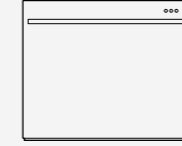

<b>Type of appliance</b>	DishDrawer™ Tall Dishwasher	DishDrawer™ Tall Dishwasher
<b>Model no.</b>	DD60SDFHTX7	DD60SHTI7
<b>Finish</b>	EZKleen stainless steel flat door	Integrated (apply your own cabinetry façade)
<b>Dimensions (excluding handles)</b>	H478 x W599 x D571mm	H454-478 x W599 x D569-573mm
<b>Energy rating</b>	A	A
<b>Noise level</b>	43dBA	43dBA
<b>Performance</b>		
SmartDrive™ technology	●	●
Water level sensing	●	●
Flow through detergent dispenser	●	●
Quiet operation	●	●
Fan assisted drying	●	●
Built-in water softener	●	●
<b>Capacity and loading</b>		
Place settings per drawer	6	6
Flexible racking system	●	●
Fold down tines	●	●
Adjustable racks and cup racks	●	●
Accommodates long stemmed glasses	●	●
Accommodates plates up to	330mm	330mm
<b>Wash programs</b>		
Nine wash programs	●	●
Eco options	●	●
Permanent memory of the last cycle used	●	●
<b>Safety</b>		
Three stage total flood protection	●	●
<b>Controls</b>		
Concealed control panels with single touch programming	●	●
Key lock	●	●
Child safety lock	●	●
End of cycle beeps	●	●
One button start	●	●
Energy saving delay start option of up to 12 hours	●	●
Rinse aid indicator light and lens	●	●
Electronic fault/Diagnostic indicator	●	●
<b>AMP draw</b>	4.5A	4.5A
<b>Accessories</b>		
Cutlery basket	●	●
Knife clip	2	2
Satin chrome badge		●
<b>Warranty</b>	1 year	1 year
<b>Available</b>	India	India

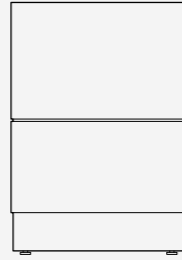
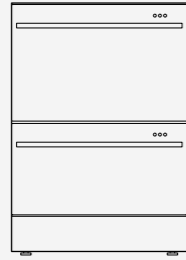

Type of appliance	DishDrawer™ Double Dishwasher	DishDrawer™ Double Dishwasher
<b>Model no.</b>	<b>DD60DDFX7</b>	<b>DD60DI7</b>
<b>Finish</b>	<b>EZKleen stainless steel flat door</b>	<b>Integrated</b> <b>(apply your own cabinetry façade)</b>
<b>Dimensions (excluding handles)</b>	H820-880 x W599 x D571mm	H820-880 x W599 x D569-573mm
<b>Energy rating</b>	3.5 star	3.5 star
<b>Energy usage</b>	134kWh per year	134kWh per year
<b>Water rating</b>	4.5 star (WELS)	4.5 star (WELS)
<b>Water usage</b>	6.7 litres per wash cycle	6.7 litres per wash cycle
<b>Performance</b>		
SmartDrive™ technology	●	●
Water level sensing	●	●
Flow through detergent dispenser	●	●
Quiet operation	●	●
Fan assisted drying	●	●
<b>Capacity and loading</b>		
Place settings per drawer	7	7
Flexible racking system	●	●
Fold down and pitch adjustable tines	●	●
Adjustable racks and cup racks	●	●
Accommodates long stemmed glasses	●	●
Accommodates plates up to	290mm	290mm
<b>Wash programs</b>		
Nine wash programs	●	●
Genuine half load wash option	●	●
Eco options	●	●
Permanent memory of the last cycle used	●	●
<b>Safety</b>		
Three stage total flood protection	●	●
<b>Controls</b>		
Wireless remote		●
Concealed control panels with single touch programming	●	●
Key lock	●	
Child lock	●	●
End of cycle beeps	●	●
One button start	●	●
Energy saving delay start option up to 12 hours	●	●
Rinse aid indicator light and lens	●	●
Electronic fault/Diagnostic indicator	●	●
<b>AMP draw</b>	9A	9A
<b>Accessories</b>		
Cutlery basket	2	2
Knife clip	4	4
Kickstrip	●	●
<b>Warranty</b>	1 year	1 year
<b>Available</b>	South East Asia	South East Asia

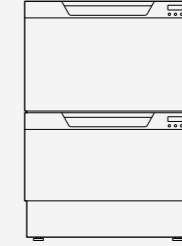
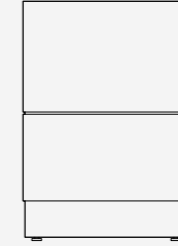
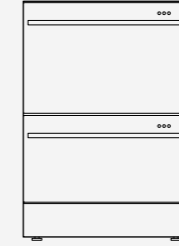

Type of appliance	DishDrawer™ Double Dishwasher	DishDrawer™ Double Dishwasher	DishDrawer™ Double Dishwasher
<b>Model no.</b>	<b>DD60DDFH7</b>	<b>DD60DIH7</b>	<b>DD60DCHX7</b>
<b>Finish</b>	<b>EZKleen stainless steel flat door</b>	<b>Integrated</b> <b>(apply your own cabinetry façade)</b>	<b>EZKleen stainless steel curved door</b>
<b>Dimensions (excluding handles)</b>	H820-880 x W599 x D571mm	H820-880 x W599 x D569-573mm	H820-880 x W599 x D582mm
<b>Energy rating</b>	A	A	A
<b>Noise level</b>	43dBA	43dBA	43dBA
<b>Performance</b>			
SmartDrive™ technology	●	●	●
Water level sensing	●	●	●
Flow through detergent dispenser	●	●	●
Quiet operation	●	●	●
Fan assisted drying	●	●	●
Built-in water softener	●	●	●
<b>Capacity and loading</b>			
Place settings per drawer	6	6	6
Flexible racking system	●	●	●
Fold down and pitch adjustable tines	●	●	●
Adjustable racks and cup racks	●	●	●
Accommodates long stemmed glasses	●	●	●
Accommodates plates up to	290mm	290mm	290mm
<b>Wash programs</b>			
Nine wash programs	●	●	●
Genuine half load wash option	●	●	●
Eco options	●	●	●
Permanent memory of the last cycle used	●	●	●
<b>Safety</b>			
Three stage total flood protection	●	●	●
<b>Controls</b>			
Concealed control panels with single touch programming	●	●	●
Key lock	●	●	●
Child safety lock	●	●	●
End of cycle beeps	●	●	●
One button start	●	●	●
Energy saving delay start option of up to 12 hours	●	●	●
Rinse aid indicator light and lens	●	●	●
Electronic fault/Diagnostic indicator	●	●	●
<b>AMP draw</b>	9A	9A	9A
<b>Accessories</b>			
Cutlery basket	2	2	2
Knife clip	4	4	4
Satin chrome badge		●	
Kickstrip	●	●	●
<b>Warranty</b>	1 year	1 year	1 year
<b>Available</b>	India	Middle East/India	Middle East



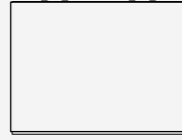

Type of appliance	DishDrawer™ Single Dishwasher	DishDrawer™ Single Dishwasher
<b>Model no.</b>	<b>DD60SDFX7</b>	<b>DD60SI7</b>
<b>Finish</b>	<b>EZKleen stainless steel flat door</b>	<b>Integrated (apply your own cabinetry façade)</b>
<b>Dimensions (excluding handles)</b>	H410 x W599 x D571mm	H410 x W599 x D569-573mm
<b>Energy rating</b>	3.5 star	3.5 star
<b>Energy usage</b>	134kWh per year	134kWh per year
<b>Water rating</b>	4.5 star (WELS)	4.5 star (WELS)
<b>Water usage</b>	6.7 litres per wash cycle	6.7 litres per wash cycle
<b>Performance</b>		
SmartDrive™ technology	●	●
Water level sensing	●	●
Flow through detergent dispenser	●	●
Quiet operation	●	●
Fan assisted drying	●	●
<b>Capacity and loading</b>		
Place settings per drawer	7	7
Flexible racking system	●	●
Fold down and pitch adjustable tines	●	●
Adjustable racks and cup racks	●	●
Accommodates long stemmed glasses	●	●
Accommodates plates up to	290mm	290mm
<b>Wash programs</b>		
Nine wash programs	●	●
Eco options	●	●
Permanent memory of the last cycle used	●	●
<b>Safety</b>		
Three stage total flood protection	●	●
<b>Controls</b>		
Wireless remote		●
Concealed control panels with single touch programming	●	●
Key lock	●	
Child lock	●	●
End of cycle beeps	●	●
One button start	●	●
Energy saving delay start option up to 12 hours	●	●
Rinse aid indicator light and lens	●	●
Electronic fault/Diagnostic indicator	●	●
<b>AMP draw</b>	4.5A	4.5A
<b>Accessories</b>		
Cutlery basket	●	●
Knife clip	2	2
<b>Warranty</b>	1 year	1 year
<b>Available</b>	South East Asia	South East Asia

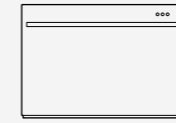

Type of appliance	DishDrawer™ Single Dishwasher	DishDrawer™ Single Dishwasher	DishDrawer™ Single Dishwasher
<b>Model no.</b>	<b>DD60SDFHX7</b>	<b>DD60SIH7</b>	<b>DD60SCHX7</b>
<b>Finish</b>	<b>EZKleen stainless steel flat door</b>	<b>Integrated (apply your own cabinetry façade)</b>	<b>EZKleen stainless steel curved door</b>
<b>Dimensions (excluding handles)</b>	H410 x W599 x D571mm	H410 x W599 x D569 - 573mm	H410 x W599 x D582mm
<b>Energy rating</b>	A	A	A
<b>Noise level</b>	43dBA	43dBA	43dBA
<b>Performance</b>			
SmartDrive™ technology	●	●	●
Water level sensing	●	●	●
Flow through detergent dispenser	●	●	●
Quiet operation	●	●	●
Fan assisted drying	●	●	●
Built-in water softener	●	●	●
<b>Capacity and loading</b>			
Place settings per drawer	6	6	6
Flexible racking system	●	●	●
Fold down and pitch adjustable tines	●	●	●
Adjustable racks and cup racks	●	●	●
Accommodates long stemmed glasses	●	●	●
Accommodates plates up to	290mm	290mm	290mm
<b>Wash programs</b>			
Nine wash programs	●	●	●
Eco options	●	●	●
Permanent memory of the last cycle used	●	●	●
<b>Safety</b>			
Three stage total flood protection	●	●	●
<b>Controls</b>			
Concealed control panels with single touch programming	●	●	●
Key lock	●	●	●
Child safety lock	●	●	●
End of cycle beeps	●	●	●
One button start	●	●	●
Energy saving delay start option of up to 12 hours	●	●	●
Rinse aid indicator light and lens	●	●	●
Electronic fault/Diagnostic indicator	●	●	●
<b>AMP draw</b>	4.5A	4.5A	4.5A
<b>Accessories</b>			
Cutlery basket	●	●	●
Knife clip	2	2	2
Satin chrome badge		●	
<b>Warranty</b>	1 year	1 year	1 year
<b>Available</b>	India	Middle East/India	Middle East

WASH

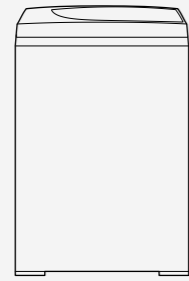

Type of appliance	10.5kg WashSmart™ Washer	8.5kg WashSmart™ Washer	7.5kg WashSmart™ Washer
<b>Model no.</b>	WA10T65GW1	WA85T60GW1	WA75T56GW1
<b>Finish</b>	White	White	White
<b>Dimensions</b>	H1030-1050 x W650 x D650mm	H1030-1050 x W600 x D600mm	H1030-1050 x W560 x D560mm
<b>Capacity (dry load)</b>	10.5kg	8.5kg	7.5kg
<b>Water usage (per wash cycle)</b>	98 litres	86 litres	78 litres
<b>Performance</b>			
SmartDrive™ technology	●	●	●
Load sensing	●	●	●
Wash profiles	16	16	16
Three spin speeds	●	●	●
Max spin speed	1000rpm	1000rpm	1000rpm
Detergent	Regular	Regular	Regular
<b>Wash cycles</b>			
Regular	●	●	●
Heavy	●	●	●
Handwash	●	●	●
Easy Iron	●	●	●
Allergy	●	●	●
Favourite	●	●	●
<b>Wash modes</b>			
Conventional	●	●	●
<b>Wash features</b>			
Auto water level	●	●	●
Manual water levels	5	5	5
Water temperature controls	6	6	6
Controlled cold	●	●	●
Rinse options	4	4	4
Soak	●	●	●
No spin/Spin hold	●	●	●
Eco	●	●	●
Quick wash	●	●	●
Time to go			●
Delay start:	1, 3, 9 hours	1, 3, 9 hours	1, 3, 9 hours
Customise cycle	●	●	●
Auto-lint disposal	●	●	●
Lid lock	●	●	●
Auto out of balance correction	●	●	●
Detergent dispenser	●	●	●
Fabric softener dispenser	●	●	●
Adjustable alert beeps	●	●	●
Stainless steel bowl	●	●	●
Agitator	Flexible finned	Flexible finned	Flexible finned
Lid	Solid ABS	Solid ABS	Solid ABS
<b>Warranty</b>			
Parts & labour	2 years	2 years	2 years
Parts only Direct Drive Motor	8 years	8 years	8 years
<b>Available</b>	South East Asia/India	South East Asia/India	South East Asia

Type of appliance	7.5kg QuickSmart™ Washer
<b>Model no.</b>	WA75T56M
<b>Finish</b>	White
<b>Dimensions</b>	H1030-1050 x W560 x D560mm
<b>Capacity (dry load)</b>	7.5kg
<b>Water usage (per wash cycle)</b>	77 litres
<b>Performance</b>	
SmartDrive™ technology	●
Load sensing	●
Wash profiles	10
Three spin speeds	●
1000 Max spin speed	●
Detergent	Regular
<b>Wash cycles</b>	
Regular	●
Heavy Duty	●
Delicate	●
Wool	●
<b>Wash modes</b>	
Conventional	●
<b>Wash features</b>	
Manual water levels	3
Water temperature controls	3
Rinse options	3
Spin hold option	●
Eco option	●
Auto-lint disposal	●
Lid lock	●
Auto out of balance correction	●
Detergent dispenser	●
Fabric softener dispenser	●
Stainless steel bowl	●
Agitator	Flexible finned
Lid	Solid ABS
<b>Warranty</b>	
Parts & labour	2 years
Parts only Direct Drive Motor	8 years
<b>Available</b>	South East Asia

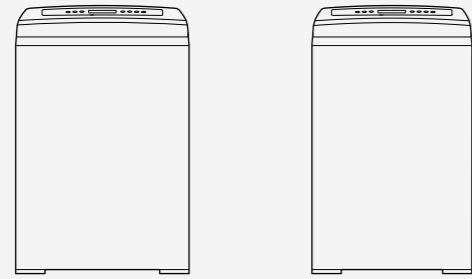

Type of appliance	10.5kg FabricSmart™ Washer	8.5kg FabricSmart™ Washer
<b>Model no.</b>	<b>WA10T65FW1</b>	<b>WA85T60FW1</b>
<b>Finish</b>	<b>White</b>	<b>White</b>
<b>Dimensions</b>	H1030-1050 x W650 x D650mm	H1030-1050 x W600 x D600mm
<b>Capacity (dry load)</b>	10.5kg	8.5kg
<b>Water usage (per wash cycle)</b>	98 litres	86 litres
<b>Performance</b>		
SmartDrive™ technology	●	●
Load sensing	●	●
Fabric sensing	●	●
Wash profiles	125	125
Three spin speeds	●	●
1000 Max spin speed	●	●
Detergent	Regular	Regular
<b>Wash cycles</b>		
Auto Sensing	●	●
Easy Iron	●	●
Wool	●	●
Handwash	●	●
Favourite	●	●
13 Lifestyle Cycles - (Allergy, Nappy Rinse, Duvet/Doona, Sweaty, Muddy, Sports Shoes, Beach Gear, Tomato, Chocolate, Blood/Grass, Fruit/Wine, Bowl Clean, Max Wash)	●	●
<b>Wash modes</b>		
Conventional	●	●
Eco-Active™	●	●
<b>Wash features</b>		
Auto water level	●	●
Manual water levels	5	5
Wash temperature controls	6	6
Controlled cold	●	●
How dirty?	●	●
Water saver options	●	●
Rinse options	6	6
Drip dry	●	●
Soak	●	●
Delay start:	15, 30 minutes, 1-10, 12, 15, 18 hours	15, 30 minutes, 1-10, 12, 15, 18 hours
Customise cycle	●	●
Save time	●	●
Auto-lint disposal	●	●
Lid lock	●	●
Auto out of balance correction	●	●
Detergent dispenser	●	●
Fabric softener dispenser	●	●
Adjustable alert beeps	●	●
Stainless steel bowl	●	●
Agitator	Flexible finned	Flexible finned
Lid	Solid ABS	Solid ABS
<b>Warranty</b>		
Parts & labour	2 years	2 years
Parts only Direct Drive Motor	8 years	8 years
<b>Available</b>	South East Asia	South East Asia/India

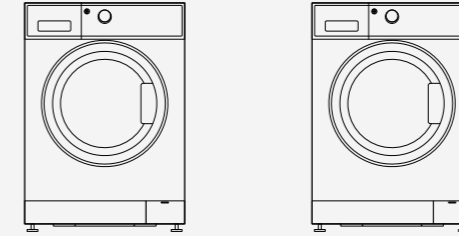

Type of appliance	8.5kg QuickSmart™ Front Load Washer	8.5kg WashSmart™ Front Load Washer
<b>Model no.</b>	<b>WH8560J1</b>	<b>WH8560P1</b>
<b>Finish</b>	<b>White</b>	<b>White</b>
<b>Dimensions</b>	H850 x W600 x D645mm	H850 x W600 x D645mm
<b>Capacity (dry load)</b>	8.5kg	8.5kg
<b>Water usage (per wash cycle)</b>	73 litres	73 litres
<b>Performance</b>		
SmartDrive™	●	●
Vortex Wash technology	●	●
Wash profiles	10	14
Spin speeds	3	4
Max spin speed	1100rpm	1400
Detergent	High Efficiency	High Efficiency
<b>Wash cycles</b>		
Cottons	●	●
Everyday	●	●
Heavy	●	●
Delicate	●	●
Easy Iron	●	●
Bulky	●	●
Allergy	●	●
Handwash	●	●
Quick	●	●
Super Quick	●	●
Drum Clean	●	●
Rinse	●	●
Spin	●	●
<b>Wash features</b>		
Water temperature controls	5	5
Soil level		3
Add a garment (immediate door opening)		●
Controlled cold	●	●
Extra rinse option	●	●
Pre Wash	●	●
No spin/Spin hold	●	●
Eco	●	●
Wrinkle Free	●	●
Time to go	●	●
Delay start	●	●
Customise cycle	●	●
Anti-fungal door gasket	●	●
Keylock	●	●
Auto out of balance correction	●	●
Excess foam detection	●	●
Flood protection	●	●
Detergent dispenser	●	●
Fabric softener dispenser	●	●
Hot and cold water inlets	●	●
Stainless steel drum	●	●
SmartTouch™ control dial	●	●
<b>Warranty</b>		
Parts & labour	2 years	2 years
Parts only Direct Drive Motor	8 years	8 years
<b>Available</b>	India	India

DRY

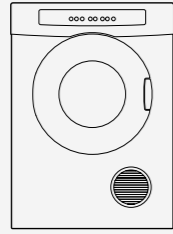

<b>Type of appliance</b>	<b>6kg AeroSense™ Dryer</b>
<b>Model no.</b>	<b>DE50F56E1</b>
<b>Finish</b>	<b>White</b>
<b>Dimensions</b>	H795 x W565 x D560mm
<b>Capacity (dry load)</b>	6kg
<b>Performance</b>	
Auto-sensing	●
Reverse tumbling	●
Quad Fin	●
LED control panel	●
Dryness settings	5
Wrinkle free option	●
Easy access lint filter	●
Manual time dry	1 hour
Delay start:	3, 6, 9 hours
Key lock	●
End of cycle signal	●
Stainless steel drum	●
Drying rack	●
Inverted panel	●
Rear venting	●
Safety restart switch	●
<b>Temperature settings</b>	
Regular	●
Low	●
Airing	●
<b>Warranty</b>	2 years
<b>Available</b>	South East Asia/India

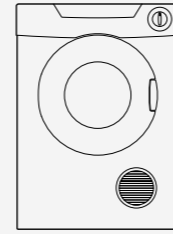

<b>Type of appliance</b>	<b>6kg AeroLogic™ Dryer</b>
<b>Model no.</b>	<b>DE50F56A2</b>
<b>Finish</b>	<b>White</b>
<b>Dimensions</b>	H795 x W565 x D560mm
<b>Capacity (dry load)</b>	6kg
<b>Performance</b>	
Reverse tumbling	●
Quad Fin	●
Easy access lint filter	●
Drying rack	●
Rear venting	●
Safety restart switch	●
<b>Temperature settings</b>	
Delicate	●
Regular	●
<b>Warranty</b>	2 years
<b>Available</b>	South East Asia

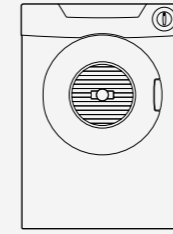

<b>Type of appliance</b>	<b>4kg AeroDry™ Timer Dryer</b>
<b>Model no.</b>	<b>DE40F56A2</b>
<b>Finish</b>	<b>White</b>
<b>Dimensions</b>	H795 x W565 x D440mm
<b>Capacity (dry load)</b>	4kg
<b>Performance</b>	
Lint filter	●
Front venting	●
<b>Temperature settings</b>	
Delicate	●
Regular	●
<b>Warranty</b>	2 years
<b>Available</b>	South East Asia



**1 Bangladesh**  
Sogo International  
Sobhan Mansion (3rd Floor)  
Suite#3, 46/1 Purana Paltan  
Dhaka-1000  
Bangladesh  
Ph: 880 2 9554590  
Fax: 880 2 9570078  
Email: sogoasian@gmail.com

**2 Dubai**  
Better Life  
Better Life & OFIS Building,  
Umm Hurair Road  
Karama, Dubai, U.A.E.  
Ph: +971 4 3309295  
Fax: +971 4 3309418  
Email: sunil@blife.ae

**3 Hong Kong**  
Kelvin Electric Trading Co., Ltd.  
Unit 1701-1703, Tower A Regent Centre  
63 Wo Yi Hop Road  
Kwai Chung  
N.T. Hong Kong  
Ph: +852 2421 1200  
Email: info@kelvinelectric.com

**4 India**  
Hi Handmade  
P-4, Satkrut Towers  
Parthsaathi Avenue  
Near Shyamai Row House II  
Satellite, Ahmedabad - 380015  
India  
Ph: +91 79 26767264/26752621  
Email: account@hifp.co.in  
customercare@hifp.co.in  
  
Shivam Industrial Corporation Ltd  
D-8, Sitapuri, Main Pankha Road  
Near Chanakya Place - I  
New Delhi - 110045  
India  
Email: fpashivam@gmail.com  
info@sicindia.org

**5 Malaysia**  
A.M. Marketing SDN. BHD  
Lot 5 Jalan Majistret U1/26  
Hicom-Glenmasie Industrial Park  
40150 Shah Alam  
Malaysia  
Ph: +60 3 78049889  
Fax: +60 3 78054348  
Email: michaelyeoh@ammarketing.com.my

**6 Philippines**  
TW & Company, Inc.  
1820 Paz Mendoza Guanzon Street  
Paco, Metro Manila  
Philippines 1007  
Ph: +63 (2) 564 1521 to 28  
Fax: +63 (2) 564 0429, 564 0434  
Email: abby\_lain3@yahoo.com

**7 Qatar**  
Almana & Partners W.L.L.  
1st floor, Nasralia Centre  
Al Khaleej Street  
P.O. Box 49, Doha  
Qatar  
Ph: +974 44422221  
Fax: +974 44439610  
Email: sales\_tech@almanapartners.com  
service\_tech@almanapartners.com

**8 Taiwan**  
Kingsware Corporation  
7F-5 No. 50 Lin Sen N. Rd  
Taipei 104  
Taiwan  
Ph: +886 2 2551 3830  
Fax: +886 2 2536 8023  
Email: info@kingsware.com.tw

**9 Thailand**  
Timsaeng 2000 Co Ltd  
2 Soi Suan Siam12, Yak12  
Kannayao, Khan Na Yao  
Bangkok 10230  
Thailand  
Ph: +66 2 9197371  
Fax: +66 2 9197493  
Email: info@ts2000.co.th  
marketing@ts2000.co.th

**10 Vietnam**  
Venus Company Limited  
32 Than Nhan Trung Str., Ward 13  
Dist. Tan Binh  
Hochiminh City  
Vietnam  
Ph: +84 83 8130569  
Fax: +84 83 8130570  
Email: info@venuscorp.com.vn

FPBR0520 MARCH 2013.  
Copyright © Fisher & Paykel 2013.  
All Rights Reserved.

Copyright © Fisher & Paykel 2013. All Rights Reserved. The product dimensions and specifications in this brochure apply to the specific products and models described at the date of issue. Under our policy of continuous product improvement, these dimensions and specifications may change at any time. You should therefore check with your dealer or Fisher & Paykel's Customer Care Centre to ensure this brochure correctly describes the products currently available.

Important Notice of Disclaimer: Our brochure contains information on a wide subject of products which we manufacture and/or sell internationally. Some particular products, models or sizes which are detailed in this brochure may not be available for sale and purchase in your area or country, if available the product may have different options to those depicted in the brochure. Before agreeing to purchase a particular product by reference to this brochure please check its availability and accuracy of its description.

