



TM

P<sup>3</sup> Architectural Solutions

# P<sup>3</sup> Architectural Solutions

PRESENTATION

ON

VAGHI

Perpetual

Project

Planning

1. 2. 1974, nuovo stabilimento,  
produzione annua 24.000 sedute.  
1974, new manufacturing,  
production per year 24,000 chairs.

1.



2.

## LA STORIA HISTORY

Vaghi nasce nel 1964 come “Tappezzeria dei Fratelli Vaghi” e, grazie all’intraprendenza dei suoi fondatori, si afferma sul mercato nazionale ed estero come azienda di riferimento per le sedute da ufficio.

**EN** Vaghi was established in 1964 as “Tappezzeria dei Fratelli Vaghi”, an upholstery shop, and thanks to entrepreneurial attitude of its founders it soon gained a position on the national and international markets, becoming a reference company in the domain of office chairs.

**FR** Vaghi naquit en 1964 comme tapisserie “Tappezzeria dei Fratelli Vaghi” et, grâce à l’esprit d’initiative de ses fondateurs, elle rejoint une position importante sur le marché national et étranger, comme point de référence dans le domaine des chaises pour bureaux.

**ES** “Tappezzeria Fratelli Vaghi”, dirigido por los hermanos Vaghi. Gracias a su espíritu emprendedor, pronto se asegura una posición en los mercados nacional e internacional, convirtiéndose así en una compañía de referencia en el sector de las sillas de oficina.

La collaborazione continua con architetti, istituti di ricerca e centri di certificazione ha permesso di proporre, in oltre cinquant'anni di storia, una serie vastissima di modelli esclusivi ispirati ai più innovativi principi del design e dell'ergonomia.

**EN** Our collaboration with architects, research organisations and certification agencies has allowed us to propose, in over fifty years of history, a number of exclusive models, inspired by the most innovative design and ergonomics.

**FR** La collaboration continue avec architectes, instituts de recherche et centres pour la certification nous a permis, en plus de cinquante ans d'histoire, de proposer une multitude de modale exclusifs, inspirées aux plus modernes principe du design et de l'ergonomie.

**ES** En más de cincuenta años de historia hemos colaborado con arquitectos, organizaciones de investigación y agencias de certificación, lo que nos ha permitido ofrecer una gran variedad de modelos exclusivos inspirados en el diseño y la ergonomía más innovadores.

1. 1973, Serie Union Group, Arch. De Matteis.
2. 1972, Serie Uno, Architetto Scolari, Griffini, Montagni.
3. 1975, Kiruna, Studio Tecnico Vaghi.

1.



2.



3.

Cura artigianale e tecnologia avanzata sono il binomio vincente, forti della conoscenza artigiana, che contraddistingue la migliore tradizione italiana, i nostri uomini sanno aggiungere alla cura dei particolari ed al design raffinato, una coraggiosa apertura alle tecnologie più avanzate, con cui affrontano problemi costruttivi ed ergonomici, assicurando il massimo del risultato ad una clientela sempre più attenta ed esigente.

**EN** Craftsmanship, combined with care and advanced technology is the winning formula, in accordance with the best Italian tradition, our artisans combine refined design with attention to detail and the most advanced technological research, in order to maximize customer satisfaction.

**FR** Soin artisanal et technologie avancée constituent le binôme gagnant, forts du bagage artisanal qui du reste distingue la meilleure tradition italienne, notre artisans savent ajouter aux soins des détails et au design raffiné une courageuse ouverture vers la recherche technologique la plus avancée, grâce à laquelle il est possible d'affronter des problèmes constructifs et ergonomiques en assurant à une clientèle toujours plus attentive et exigeante le maximum des résultats.

**ES** Las habilidades artesanales y la tecnología avanzada son la combinación ganadora, con la experiencia artesanal que distingue a la mejor tradición italiana, nuestros hombres añaden a la atención al detalle y al diseño refinado una apertura valiente a la investigación tecnológica más avanzada, con la que enfrentar problemas de construcción y ergonómicos, ofreciendo los máximos resultados a una clientela cada vez más atenta y exigente.

**OGGI TODAY**

1. 2019, Libera, Orlandini Design.

2. 2020, Mewa, Satyendra Pakhalé.

3. 2000, Union Executive, Vaghi R&D.

1.



2.



3.

I nostri prodotti sono progettati per essere facilmente disassemblati alla fine del ciclo di vita, in modo da ridurre l'impatto ambientale e permettere un futuro riutilizzo o riciclo. Our products are projected to be easily disassembled at the end of the life cycle, in order to reduce the environmental impact and to allow a future re-use or recycle.



SOSTENIBILITÀ SUSTAINABILITY



La sostenibilità,  
per noi, è un impegno  
reale: siamo sempre alla  
ricerca di nuovi metodi  
per allungare la durata  
dei nostri prodotti  
e ridurre il loro impatto  
sull'ambiente.  
Abbiamo elaborato  
politiche e rigidi  
standard operativi,  
per garantire a ognuno  
dei nostri dipendenti  
un ambiente di lavoro  
sano e sicuro.

**EN** We are continually investing in sustainability: we are always looking for new ways to extend product lifespan and reduce our impact on the environment, we work with suppliers to ensure that our products are as low-impact as possible. We have adopted strict operating standards that make sure all our employees enjoy a safe, healthy workplace.

**FR** Nous investissons en permanence dans le développement durable: cherchant continuellement de nouvelles manières d'accroître la durée de vie de nos produits, mais aussi de réduire notre impact sur l'environnement. Nous avons également adopté des normes d'exploitation strictes, qui garantissent à tous nos employés un environnement de travail sûr et sain.

**ES** Invertimos continuamente en sostenibilidad: buscando siempre nuevos modos de ampliar la duración del producto y reducir el impacto medioambiental. Adoptamos normas operativas estrictas para asegurar que todos nuestros empleados puedan disfrutar de un lugar de trabajo seguro y sano.

Le nostre certificazioni:

- Sistema di gestione della qualità  
UNI EN ISO 9001:2015
- Sistema di gestione ambientale  
UNI EN ISO 14001:2015

**EN** Our certifications:

- Quality Management System  
UNI EN ISO 9001:2015
- Environmental Management System  
UNI EN ISO 14001:2015

**FR** Nos certifications:

- Systèmes de management de la qualité  
UNI EN ISO 9001:2015
- Système de management environnemental  
UNI EN ISO 14001:2015

**ES** Nuestras certificaciones:

- Sistema de gestión de la calidad  
UNI EN ISO 9001:2015
- Sistema de gestión ambiental  
UNI EN ISO 14001:2015



# INDICE INDEX

## 001 DIREZIONALI EXECUTIVE

- 003 VIVA
- 019 YALTA
- 027 EXPO.15
- 035 SUONI
- 051 MODUS 150
- 063 GEMINI
- 077 MAEVA
- 095 UNION
- 115 AQABA
- 127 KIRUNA

## 141 OPERATIVE TASK

- 143 ASSIA EV
- 151 ASSIA CL
- 159 EXPO LIGHT LR/LI
- 167 EXPO LIGHT QX/LX E IQ/IX
- 183 BURSA RETE EVOLUTION WHITE
- 191 BURSA RETE EVOLUTION BLACK
- 199 BURSA RETE
- 211 AVILA BURSA
- 219 MOREA COMFORT
- 235 MALTA
- 241 LYBRA
- 247 SULKY

## 253 OSPITI GUEST

- 255 LIBERA LI/LC
- 271 GAIO
- 277 WIZARD E GIAVA
- 287 MALTA CONTRACT
- 293 101 RETE
- 301 SULKY 201
- 307 TARIFA 101

## 313 ATTESE WAITING

- 315 VIVA BENCH
- 323 MEWA
- 337 MODULIA
- 343 OREOTTO
- 351 MATIS
- 359 ALIAS
- 375 LIBERA LP/LS
- 383 LINEA R
- 389 LINEA TRE
- 397 LINEA M
- 405 COMPLEMENTI COFFEE TABLES

## 415 PELLI E TESSUTI FABRICS AND LEATHERS

# DIREZIONALI EXECUTIVE

003 VIVA

019 YALTA

027 EXPO.15

035 SUONI

051 MODUS 150

063 GEMINI

077 MAEVA

095 UNION

115 AQABA

127 KIRUNA





# VIVA EXECUTIVE ARMCHAIR

Design by ORLANDINIDESIGN

Seduta da lavoro  
s sofisticata,  
dall'estetica  
morbida e naturale.  
Colpisce per  
l'ergonomia  
e per il design  
che trasmette un  
senso di sicurezza  
e protezione.

**EN** Sophisticated work chair  
with a soft and organic  
aesthetic. It catches the eye  
with its ergonomics  
and a design in which one  
feels fully at home and at ease.

**FR** Chaise de travail sophistiquée,  
avec l'esthétique douce  
et organique. Il séduit par  
son ergonomie et un design  
rassurant qui fait que l'on  
s'y sent bien.

**ES** Silla de oficina sofisticada,  
con una estética suave  
y orgánica. Llama la atención  
por su ergonomía y por gozar  
de un diseño con el que uno  
se siente completamente  
a gusto y en casa.



Configura la tua seduta /  
Set up your chair



Guarda il video /  
Watch the video

DIREZIONALI EXECUTIVE  
VIVA EXECUTIVE ARMCHAIR



VB58X



VIS6L





DIREZIONALI EXECUTIVE  
VIVA EXECUTIVE ARMCHAIR

VBS8X



VIS6L



SCHIENALE REGOLABILE ADJUSTABLE BACKREST

## FINITURE FINISHES

### PARTI METALLICHE METAL PARTS

Verniciato nero / Black painted / Verni couleur noir / Acabado en negro

### PARTI IN PLASTICA PLASTIC PARTS

Nero / Black / Noir / Negro  
Bianco / White / Blanc / Blanco

### PARTI IN ALLUMINIO ALUMINIUM PARTS

Lucido o verniciato nero, bianco (RAL 9016) / Polished or black, white (RAL 9016) painted / Poli ou verni couleur noir, blanc (RAL 9016) / Pulido o acabado en negro, blanco (RAL 9016)

## ACCESSORI ACCESSORIES

### POGGIATESTA HEADREST

Imbottito / Upholstered / Rembouré / Tapizado

### BRACCIOLO ARMREST

Imbottito / Upholstered / Rembouré / Tapizado

### BASE GIREVOLE SWIVEL BASE

Alluminio a 5 razze / Aluminium 5 stars / Aluminium 5 branches / Aluminio de 5 radios

## RIVESTIMENTI COVERINGS



pelle  
leather  
cuir  
cuero

EP - FP



tessuto  
fabric  
tissu  
tela

AG - AR - BR - BB - BL  
CT - CE - DB - ET

## MISURE E VARIANTI SIZES AND VARIANTS

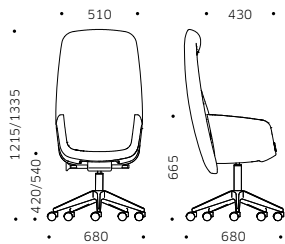

VBS8X

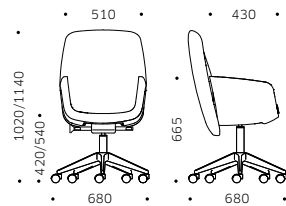

VIS6L

## CERTIFICAZIONI CERTIFICATIONS

Omologazione Ministeriale in Classe 11M

## DOTAZIONI MECCANICHE MECHANICAL FEATURES

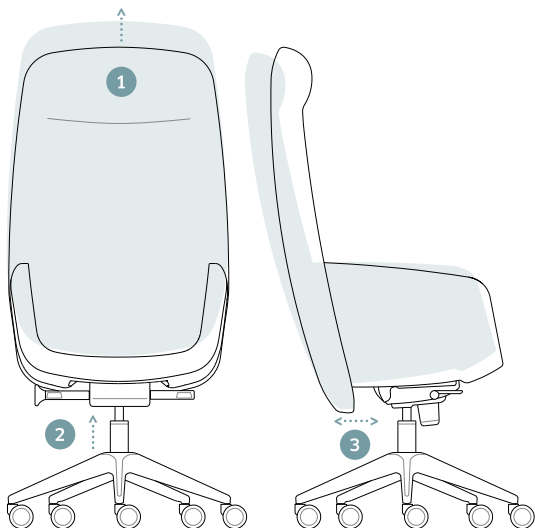

- 1 Schienale regolabile in altezza / Adjustable backrest / Dossier ajustable en hauteur / Respaldo regulable en altura
- 2 Sedile regolabile in altezza / Height adjustable seat / Siège réglable en hauteur / Asiento regulable en altura
- 3 Meccanismo di inclinazione sincronizzata / Seat and back synchronized inclination mechanism / Mécanisme d'inclinaison synchronisé du siège et du dossier / Mecanismo de inclinación de asiento y respaldo sincronizada

Dispositivo regolazione di tensione / Device for tension adjustment / Système d'ajustement de la tension / Dispositivo de ajuste de tensión de oscilación

Sistema di sicurezza antiritorno / Anti-return safety system / Système de sécurité anti-retour / Mecanismo de seguridad anti-retorno





# VIVA GUEST CHAIR

Design by ORLANDINIDESIGN

Il design  
accogliente  
offre un comfort  
di alto livello  
e tutto il relax  
di una seduta  
ospiti. Al contempo,  
la posizione  
di seduta consente  
di lavorare anche  
per lungo tempo.

**EN** Its inviting look provides great comfort in a lounge seating style. At the same time, the sitting posture allows working for extended periods.

**FR** Son caractère accueillant allie confort et détente. La position d'assise permet de travailler même sur une période prolongée.

**ES** Su carácter acogedor ofrece una gran comodidad y la sensación de estar sentado en un salón. La postura, pero al mismo tiempo fomenta el trabajo, incluso estando sentado durante mucho tiempo.



Configura la tua seduta /  
Set up your chair



Guarda il video /  
Watch the video

DIREZIONALI EXECUTIVE  
VIVA GUEST CHAIR



V120B



V12GN





V104L - V120N - VB20W - V12AL - V12GB

DIREZIONALI EXECUTIVE  
VIVA GUEST CHAIR

V104B



BASE GIREVOLE SWIVEL BASE

V12AL



V12GN



V120B



VB20W



BASE FISSA FIXED BASE

## MISURE E VARIANTI SIZES AND VARIANTS

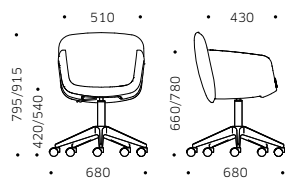

V104B

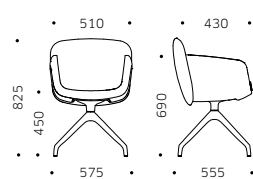

V12AL / V12GN

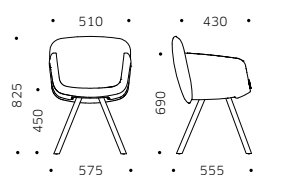

V120B

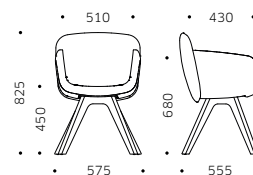

VB20W

## CERTIFICAZIONI CERTIFICATIONS

EN 16139 EN 1022 EN 1728 Test by CATAS  
Omologazione Ministeriale in Classe 1IM

## FINITURE FINISHING

### PARTI METALLICHE METAL PARTS

Cromato, verniciato nero o bianco (RAL 9016) / Chromed, black or white (RAL 9016) painted / Chrome, verni couleur noir ou blanc (RAL 9016) / Cromo, acabado en negro o blanco (RAL 9016)

### PARTI IN PLASTICA PLASTIC PARTS

Nero / Black / Noir / Negro  
Bianco / White / Blanc / Blanco

### PARTI IN LEGNO WOODEN PARTS

Faggio / Beechwood / Hêtre / Haya

### PARTI IN ALLUMINIO ALUMINIUM PARTS

Lucido, verniciato nero o bianco (RAL 9016) / Polished, black or white painted (RAL 9016) / Poli, verni couleur noir ou blanc (RAL 9016) / Pulido, acabado en negro o blanco (RAL 9016)

## ACCESSORI ACCESSORIES

### BRACCIOLO ARMREST

Imbottito / Upholstered / Rembouré / Tapizado

### BASE GIREVOLE SWIVEL BASE

Alluminio a 5 razze / Aluminium 5 stars / Aluminium 5 branches /  
Aluminio de 5 radios  
Alluminio a 4 razze / Aluminium 4 stars / Aluminium 4 branches /  
Aluminio de 4 radios  
Poliamide a 4 razze / Polyamide 4 spoke / Polyamide 4 branches /  
Poliamida de 4 radios

### BASE FISSA FIXED BASE

Legno a 4 gambe / Wooden 4 legs / Piètement 4 pieds en bois /  
4 patas de madera  
Acciaio a 4 gambe / Steel 4 legs / Piètement 4 pieds en acier /  
4 patas de acero

## RIVESTIMENTI COVERINGS



pelle  
leather  
cuir  
cuero

### EP - FP



tessuto  
fabric  
tissu  
tela

AG - AR - BR - BB - BL - CT - CE - DB - ET

## DOTAZIONI MECCANICHE TECHNICAL FEATURES

Sedile regolabile in altezza / Oscillante armonico

EN Height adjustable seat / Tilt mechanism

FR Siège réglable en hauteur / Mécanisme pivotant

ES Asiento regulable en altura / Mecanismo oscilante





# YALTA EXECUTIVE AND GUEST CHAIR

Design by Vaghi R&D

Grazie  
al suo design  
distintivo e  
contemporaneo,  
al comfort  
di seduta e alla  
funzionalità  
intuitiva, è  
perfetta per  
l'ufficio e per  
l'home office.

**EN** A distinctive, contemporary design, comfortable seating and intuitive functionality make it perfect for office areas and home offices as well.

**FR** Affichant des lignes modernes et agréables, ce siège se distingue par son grand confort et ses fonctionnalités intuitives. Il s'intègre à merveille dans tous les espaces de bureaux où d'home offices.

**ES** Gracias a su diseño diferencial y contemporáneo, su confort y sus funcionalidades intuitivas resulta idónea para la oficina y el home office.



Guarda il video /  
Watch the video

DIREZIONALI EXECUTIVE  
YALTA EXECUTIVE AND GUEST CHAIR



Y2A8L



Y1A6X





Y2A8X - Y2A6X - Y1A8X - Y1A6X

DIREZIONALI EXECUTIVE  
YALTA EXECUTIVE AND GUEST CHAIR

Y1A8X



Y1A6X



PLASTICA BIANCO AVORIO, BASE ALLUMINIO LUCIDO IVORY PLASTIC, POLISHED ALUMINIUM BASE

Y2A8L



Y2A6L



PLASTICA NERA, BASE ALLUMINIO NERO BLACK PLASTIC, BLACK ALUMINIUM BASE

## MODELLI DISPONIBILI AVAILABLE MODELS

### Y1

Plastica bianco avorio  
Ivory plastics  
Plastique blanc ivoire  
Plástico blanco marfil

### Y2

Plastica nera  
Black plastic  
Plastique noir  
Plástico negro

## MISURE E VARIANTI SIZES AND VARIANTS

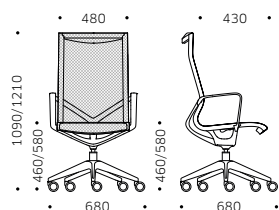

Y1A8X - Y2A8L

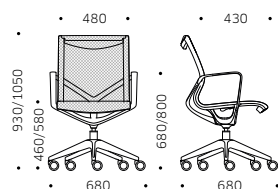

Y1A6X - Y2A6L

## CERTIFICAZIONI CERTIFICATIONS

EN 1335 Test by CATAS

## DOTAZIONI MECCANICHE MECHANICAL FEATURES

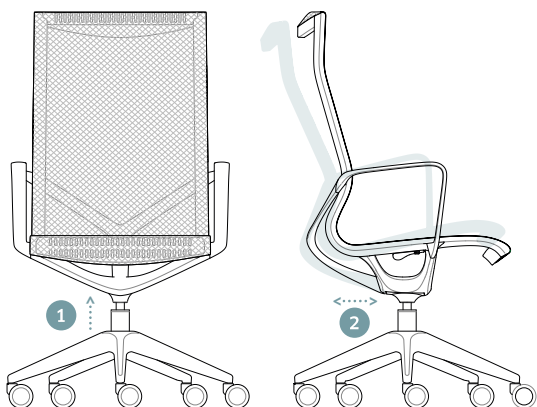

- 1 Sedile regolabile in altezza / Height adjustable seat / Siège réglable en hauteur / Asiento regulable en altura
- 2 Oscillante armonico / Tilt mechanism / Mécanisme pivotant / Mecanismo oscilante

## FINITURE FINISHES

### PARTI METALLICHE METAL PARTS

Cromato, verniciato nero / Chromed, black painted /  
Chrome, verni couleur noir / Cromo, acabado en negro

### PARTI IN ALLUMINIO ALUMINIUM PARTS

Lucido, verniciato nero / Polished, black painted /  
Poli, verni couleur noir / Pulido, acabado en negro

### PARTI IN PLASTICA PLASTIC PARTS

Nero o bianco avorio / Black or Ivory / Noir ou Blanc Ivoire /  
Negro o Blanco marfil

## ACCESSORI ACCESSORIES

### POGGIATESTA HEADREST

In rete / Mesh / Maille / De malla

### BRACCIOLI ARMREST

in plastica / Plastic / En plastique / En plástico

### BASE GIREVOLE SWIVEL BASE

Alluminio a 5 razze / Aluminium 5 stars / Aluminium 5 branches /  
Aluminio de 5 radios  
Poliammide a 5 razze / Polyamide 5 stars / Polyamide 5 branches /  
Poliamida de 5 radios

## RIVESTIMENTI COVERINGS



rete  
netting  
réseau  
red

RP





# EXPO.15 EXECUTIVE ARMCHAIR

Design by Baldanzi & Novelli

Che si scelga  
la classica versione  
imbottita  
o la variante  
in rete, tutti  
i modelli  
colpiscono  
per il design,  
l'innovazione  
e il comfort.

**EN** Whether classically upholstered or with a mesh backrest, all models impress with their design, innovation and comfort.

**FR** Qu'ils présentent un capitonnage classique ou un dossier e maille, tous les modèles séduisent par leur élégance, innovation et confort.

**ES** Ya sea con un tapizado clásico o con un respaldo de malla, todos los modelos impresionan por su diseño, innovación y comodidad.



Configura la tua seduta /  
Set up your chair





GDTXX < GDTMX ^





DIREZIONALI EXECUTIVE  
EXPO.15 EXECUTIVE ARMCHAIR

EDTXX



EDTMX



SCHIENALE IN RETE MESH BACKREST

GDTXX



GDTMX



SCHIENALE IN RETE CON CUSCINO MESH BACKREST WITH CUSHION

## MODELLI DISPONIBILI AVAILABLE MODELS

### EX

Schienale in rete / Mesh backrest  
Dossier en maille / Respaldo de malla

### GX

Schienale in rete con cuscino / Mesh backrest with cushion  
Dossier en maille avec coussin / Respaldo de malla con cojín

## MISURE E VARIANTI SIZES AND VARIANTS

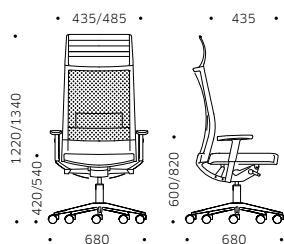

EDTXX

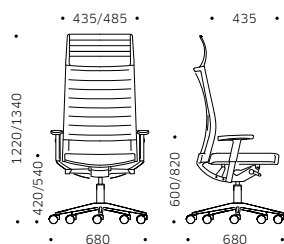

GDTXX

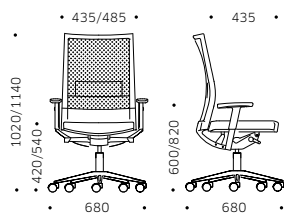

EDTMX

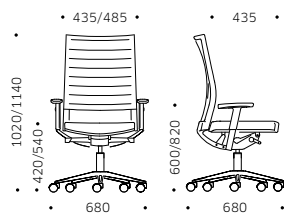

GDTMX

## DOTAZIONI MECCANICHE MECHANICAL FEATURES

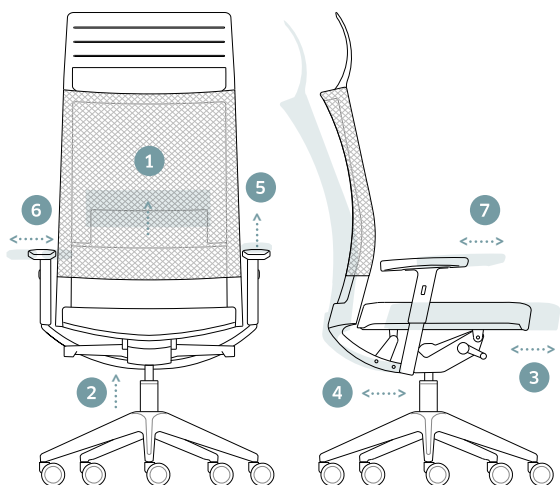

- 1 Appoggio lombare regolabile in altezza / Height adjustable lumbar support / Support lombaire ajustable en hauteur / Soporte lumbar regulable en altura /
- 2 Sedile regolabile in altezza / Height adjustable seat / Siège réglable en hauteur / Asiento regulable en altura /
- 3 Sedile regolabile in profondità / Depth-adjustable seat / Siège réglable en profondeur / Asiento regulable en profundidad /
- 4 Meccanismo di inclinazione sincronizzata / Seat and back synchronized inclination mechanism / Mécanisme d'inclinaison synchronisé du siège et du dossier / Mecanismo de inclinación de asiento y respaldo sincronizada /  
Dispositivo regolazione di tensione / Device for tension adjustment / Système d'ajustement de la tension / Dispositivo de ajuste de tensión de oscilación /  
Sistema di sicurezza antiritorno / Anti-return safety system / Système de sécurité anti-retour / Mecanismo de seguridad anti-retorno /
- 5 Bracciolo regolabile in altezza / Height-adjustable armrest / Accoudoir ajustable en hauteur / Reposabrazos ajustable en altura /
- 6 Appoggio bracciolo orientabile e regolabile in larghezza / Width-adjustable armrest, pivoting arm-cap / Accoudoir ajustable en largeur avec support pivotant / Reposabrazos ajustable en anchura con apoyobrazo orientable
- 7 Appoggio bracciolo regolabile in profondità / Depth-adjustable armrest / Accoudoir ajustable en profondeur / Reposabrazos ajustable en profundidad

## FINITURE FINISHES

### PARTI METALLICHE METAL PARTS

Verniciato nero / Black painted / Verni couleur noir / Acabado en negro

### PARTI IN PLASTICA PLASTIC PARTS

Nero / Black / Noir / Negro

### PARTI IN ALLUMINIO ALUMINIUM PARTS

Lucido, verniciato nero / Polished, black painted / Poli, verni couleur noir / Pulido, acabado en negro

## ACCESSORI ACCESSORIES

### POGGIATESTA HEADREST

Imbottito o polipropilene / Upholstered or polypropylene / Rembouré ou polypropylène / Tapizado o polipropileno

### BRACCIOLLO ARMREST

Forma a "T" con appoggio in poliuretano / "T" shaped with polyurethane pad / En forme de "T" avec soutien en polyuréthane / En forma de "T" con apoyo en poliuretano

### BASE GIREVOLE SWIVEL BASE

Alluminio a 5 razze / Aluminium 5 stars / Aluminium 5 branches / Aluminio de 5 radios

## RIVESTIMENTI COVERINGS



rete  
netting  
réseau  
red

RE - RS



pelle  
leather  
cuir  
cuero

EP - FP



tessuto  
fabric  
tissu  
tela

AG - AR - AL - BR

BB - BL - CR - CT

CE - DB - ET

## CERTIFICAZIONI CERTIFICATIONS

D.L. 81/08 EN 1335 Test by CATAS





# SUONI EXECUTIVE ARMCHAIR

Design by Vaghi R&D

Il design si combina con la migliore maestria artigianale: lo schienale alto scolpito e i contorni leggermente curvi favoriscono il comfort di seduta. Disponibile rivestita o con esterno impiallacciato in palissandro.

**EN** Design combines with the finest craftsmanship: the high sculpted back and gently curving contours enhance the seating comfort. Available fully upholstered or with a rosewood veneered outer back.

**FR** Le design combiné avec le plus grand savoir-faire: le haut dossier sculpté et les contours légèrement incurvés garantissent le confort d'assise. Disponible avec tapissage intégral ou extérieur plaqué en bois de rose.

**ES** El diseño se combina con la mejor artesanía: el respaldo esculpido alto y los contornos suavemente curvados prometen una comodidad al sentarse. Disponible tapizada completamente o con exterior chapado en palo de rosa.





SHD8X < SID6X ^





SLD8X - SID8X - SHD8X

DIREZIONALI EXECUTIVE  
SUONI EXECUTIVE ARMCHAIR

SHD8X



SCOCCA RIVESTITA, PROFILO IN CONTRASTO UPHOLSTERED SHELL, CONTRASTING PROFILED EDGE

SID8X



SID6X



SCOCCA RIVESTITA, PROFILO IN TINTA UPHOLSTERED SHELL, PLAIN PROFILED EDGE

SLD8X



SLD8L



SCOCCA IN LEGNO, PROFILO IN TINTA WOODEN SHELL, PLAIN PROFILE EDGE

## MODELLI DISPONIBILI AVAILABLE MODELS

### SL

Scocca in legno, profilo in tinta  
Wooden shell, plain profiled edge  
Coque en bois, profil dans teinte  
Cuerpo de madera, perfil en tinte

### SM

Scocca in legno, profilo in contrasto  
Wooden shell, contrasting profiled edge  
Coque en bois, profil contrastant  
Cuerpo de madera, perfil contrastante

### SI

Scocca rivestita, profilo in tinta  
Upholstered shell, plain profiled edge  
Coque rembouré, profil dans teinte  
Cuerpo tapizado, perfil en tinte

### SH

Scocca rivestita, profilo in contrasto  
Upholstered shell, contrasting profiled edge  
Coque rembouré, profil contrastant  
Cuerpo tapizado, perfil contrastante

## MISURE E VARIANTI SIZES AND VARIANTS

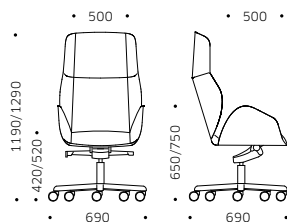

SID8X / SHD8X

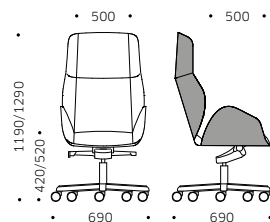

SLD8X / SLD8L

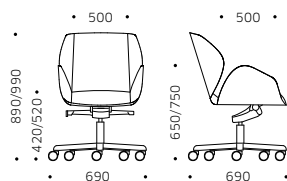

SID6X

## CERTIFICAZIONI CERTIFICATIONS

EN 1335 Test by CATAS

## FINITURE FINISHES

### PARTI METALLICHE METAL PARTS

Verniciato nero / Black painted / Verni couleur noir / Acabado en negro

### PARTI IN PLASTICA PLASTIC PARTS

Nero / Black / Noir / Negro

### PARTI IN LEGNO WOODEN PARTS

Palissandro / Rosewood / Bois de rose / Palo de rosa

### PARTI IN ALLUMINIO ALUMINIUM PARTS

Lucido o verniciato nero / Polished or black painted / Poli ou verni couleur noir / Pulido o acabado en negro

## ACCESSORI ACCESSORIES

### POGGIATESTA HEADREST

Imbottito / Upholstered / Rembouré / Tapizado

### BRACCIOLO ARMREST

Imbottito / Upholstered / Rembouré / Tapizado

### BASE GIREVOLE SWIVEL BASE

Alluminio a 5 razze / Aluminium 5 stars / Aluminium 5 branches / Aluminio de 5 radios

Alluminio a 5 razze con inserti in legno / Aluminium 5 stars with wood pads / Aluminium 5 branches avec inserts en bois / Aluminio de 5 radios con inserciones de madera

## RIVESTIMENTI COVERINGS



AG - AR - BR - BB - BL - CT - CE - DB - ET



EP - FP

## DOTAZIONI MECCANICHE TECHNICAL FEATURES

Sedile regolabile in altezza / Meccanismo oscillante / Dispositivo regolazione di tensione / Sistema di sicurezza antiritorno

EN Height adjustable seat / Tilt mechanism / Device for tension adjustment / Anti-return safety system

FR Siège réglable en hauteur / Mécanisme pivotant / Système d'ajustement de la tension / Système de sécurité anti-retour

ES Asiento regulable en altura / Mecanismo oscilante / Dispositivo de ajuste de tensión de oscilación / Mecanismo de seguridad anti-retorno





# SUONI GUEST CHAIR

Design by Vaghi R&D

Fusione tra classico e contemporaneo, il suo profilo distintivo la rende un pezzo unico per esaltare qualsiasi ambiente direzionale. Disponibile rivestita o con esterno impiallacciato in palissandro.

**EN** A fusion of classic and contemporary, its distinctive profile makes it a stand-alone statement piece to enhance any executive area. Available fully upholstered or with a rosewood veneered outer back.

**FR** Fusionne entre classique et contemporain, son profil original en fait un élément qui rehaussera tout salon de direction. Disponible avec tapissage intégral ou extérieur plaqué en bois de rose.

**ES** Una fusión de clásico y contemporáneo, su perfil distintivo lo hace una pieza exclusiva para mejorar cualquier área de salón ejecutivo. Disponible tapizada completamente o con exterior chapado en palo de rosa.

DIREZIONALI EXECUTIVE  
SUONI GUEST CHAIR



SLO6X



S106X





S106K

DIREZIONALI EXECUTIVE  
SUONI GUEST CHAIR

SI06X



SI06K



SCOCCA RIVESTITA, PROFILO IN TINTA UPHOLSTERED SHELL, PLAIN PROFILED EDGE

SL06X



SCOCCA IN LEGNO, PROFILO IN TINTA WOODEN SHELL, PLAIN PROFILED EDGE

## MODELLI DISPONIBILI AVAILABLE MODELS

### SL

Scocca in legno, profilo in tinta  
Wooden shell, plain profiled edge  
Coque en bois, profil dans teinte  
Cuerpo de madera, perfil en tinte

### SM

Scocca in legno, profilo in contrasto  
Wooden shell, contrasting profiled edge  
Coque en bois, profil contrastant  
Cuerpo de madera, perfil contrastante

### SI

Scocca rivestita, profilo in tinta  
Upholstered shell, plain profiled edge  
Coque rembouré, profil dans teinte  
Cuerpo tapizado, perfil en tinte

### SH

Scocca rivestita, profilo in contrasto  
Upholstered shell, contrasting profiled edge  
Coque rembouré, profil contrastant  
Cuerpo tapizado, perfil contrastante

## MISURE E VARIANTI SIZES AND VARIANTS

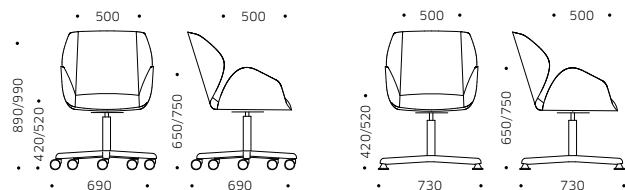

S106X / SL06X

S106K

## CERTIFICAZIONI CERTIFICATIONS

EN 16139 EN 1022 EN 1728 Test by CATAS

## FINITURE FINISHES

### PARTI METALLICHE METAL PARTS

Verniciato nero / Black painted / Verni couleur noir / Acabado en negro

### PARTI IN PLASTICA PLASTIC PARTS

Nero / Black / Noir / Negro

### PARTI IN LEGNO WOODEN PARTS

Palissandro / Rosewood / Bois de rose / Palo de rosa

### PARTI IN ALLUMINIO ALUMINIUM PARTS

Lucido o verniciato nero / Polished or black painted / Poli ou verni couleur noir / Pulido o acabado en negro

## ACCESSORI ACCESSORIES

### BRACCIOLO ARMREST

Imbottito / Upholstered / Rembouré / Tapizado

### BASE GIREVOLE SWIVEL BASE

Alluminio a 5 razze / Aluminium 5 stars / Aluminium 5 branches /  
Aluminio de 5 radios  
Alluminio a 5 razze con inserti in legno / Aluminium 5 stars with  
wood pads / Aluminium 5 branches avec inserts en bois / Aluminio  
de 5 radios con inserciones de madera  
Alluminio a 4 razze / Aluminium 4 stars / Aluminium 4 branches /  
Aluminio de 4 radios

## RIVESTIMENTI COVERINGS



tessuto  
fabric  
tissu  
tela

AG - AR - BR - BB - BL - CT - CE - DB - ET



pelle  
leather  
cuir  
cuero

EP - FP

## DOTAZIONI MECCANICHE TECHNICAL FEATURES

Sedile regolabile in altezza

EN Height adjustable seat

FR Siège réglable en hauteur

ES Asiento regulable en altura





# MODUS 150 EXECUTIVE ARMCHAIR

Design by Vaghi R&D

Eleganza  
e raffinatezza  
si abbinano  
ad un notevole  
comfort di seduta,  
rendendola idonea  
all'utilizzo  
in ambienti di  
rappresentanza.

**EN** High-quality elegance combined with its impressive seating comfort make it perfect for representative offices.

**FR** Se distingue par son élégance et sa haute qualité, le remarquable confort fait qu'il trouve aussi bien sa place dans les salles haut de gamme.

**ES** Elegancia y máxima calidad, lo que, unido a su extraordinario confort, lo convierte en la elección idónea para salas representativas.

DIREZIONALI EXECUTIVE

MODUS 150 EXECUTIVE ARMCHAIR



150SC ^ 154SC >



DIREZIONALI EXECUTIVE

## MODUS 150 EXECUTIVE ARMCHAIR

150SC



154SC



## MISURE E VARIANTI SIZES AND VARIANTS

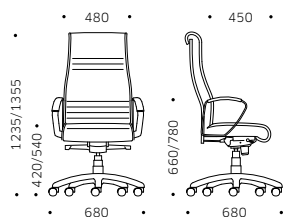

1505C

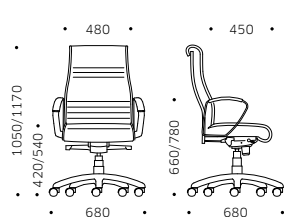

1545C

## CERTIFICAZIONI CERTIFICATIONS

EN 1335 Test by CATAS

## FINITURE FINISHES

### PARTI METALLICHE METAL PARTS

Verniciato nero o cromato / Black painted or chromed / Verni couleur noir ou chrome / Acabado en negro o cromo

### PARTI IN PLASTICA PLASTIC PARTS

Nero / Black / Noir / Negro

### PARTI IN ALLUMINIO ALUMINIUM PARTS

Lucido o verniciato nero / Polished or black painted / Poli ou verni couleur noir / Pulido o acabado en negro

## ACCESSORI ACCESSORIES

### POGGIATESTA HEADREST

Imbottito / Upholstered / Rembouré / Tapizado

### BRACCIOLLO ARMREST

Acciaio con appoggio rivestito / Steel with upholstered pad / Acier avec soutien rembouré / Acero con apoyo tapizado

### BASE GIREVOLE SWIVEL BASE

Alluminio a 5 razze / Aluminium 5 stars / Aluminium 5 branches / Aluminio de 5 radios

## RIVESTIMENTI COVERINGS



tessuto  
fabric  
tissu  
tela

AG - AR - BR - BB - BL - CT - CE - DB - ET



pelle  
leather  
cuir  
cuero

EP - FP

## DOTAZIONI MECCANICHE TECHNICAL FEATURES

Sedile regolabile in altezza / Meccanismo di inclinazione sincronizzata / Dispositivo regolazione di tensione / Sistema di sicurezza antiritorno

- EN Height adjustable seat / Seat and back synchronized inclination mechanism / Device for tension adjustment / Anti-return safety system
- FR Siège réglable en hauteur / Mécanisme d'inclinaison synchronisé du siège et du dossier / Système d'ajustement de la tension / Système de sécurité anti-retour
- ES Asiento regulable en altura / Mecanismo de inclinación de asiento y respaldo sincronizada / Dispositivo de ajuste de tensión de oscilación / Mecanismo de seguridad anti-retorno



# MODUS 150 GUEST CHAIR

Design by Vaghi R&D

Una variegata  
collezione  
di sedute per  
visitatori e  
sale riunioni  
utilizzabili in  
diversi ambienti.

**EN** Extensive range of versatile  
matching visitor  
and conference chairs.

**FR** Proposés dans de nombreux  
modèles, déclinant à la fois  
sièges visiteurs et sièges  
de conférence, ils présentent  
une grande polyvalence.

**ES** Amplia gama de versátiles  
sillas de conferencias y visitas  
que combinarán con cualquier  
estilo de oficina.







516FC - 512C < 512C ^

DIREZIONALI EXECUTIVE  
MODUS 150 GUEST CHAIR

512C



516FC



## MISURE E VARIANTI SIZES AND VARIANTS

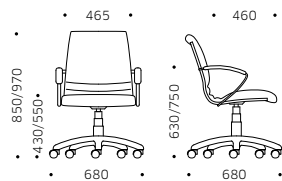

516FC

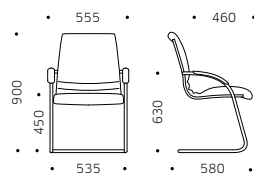

512C

## CERTIFICAZIONI CERTIFICATIONS

EN 16139 EN 1022 EN 1728 Test by CATAS

## FINITURE FINISHES

### PARTI METALLICHE METAL PARTS

Verniciato nero o cromato / Black painted or chromed / Verni couleur noir ou chrome / Acabado en negro o cromo

### PARTI IN PLASTICA PLASTIC PARTS

Nero / Black / Noir / Negro

### PARTI IN ALLUMINIO ALUMINIUM PARTS

Lucido o verniciato nero / Polished or black painted / Poli ou verni couleur noir / Pulido o acabado en negro

## ACCESSORI ACCESSORIES

### BRACCIOLO ARMREST

Acciaio con appoggio in poliuretano / Steel with polyurethane pad / Acier avec soutien en polyuréthane / Acero con apoyo en poliuretano

### BASE GIREVOLE SWIVEL BASE

Alluminio a 5 razze / Aluminium 5 stars / Aluminium 5 branches / Aluminio de 5 radios  
Poliammide a 5 razze / Polyamide 5 stars / Polyamide 5 branches / Poliamida de 5 radios

### BASE FISSA FIXED BASE

A cantilever con braccioli, appoggio in poliuretano / Cantilever with armrests, polyurethane pad / Piètement luge avec accoudoirs, soutien en polyuréthane / Trineo con apoyabrazos, apoyo en poliuretano

## RIVESTIMENTI COVERINGS



tessuto  
fabric  
tissu  
tela

AG - AR - BR - BB - BL - CT - CE - DB - ET



pelle  
leather  
cuir  
cuero

EP - FP

## DOTAZIONI MECCANICHE TECHNICAL FEATURES

Sedile regolabile in altezza

- EN Height adjustable seat
- FR Siège réglable en hauteur
- ES Asiento regulable en altura



# GEMINI EXECUTIVE ARMCHAIR

Design by Vaghi R&D

Le sue linee fluide,  
il carattere distintivo,  
le prestazioni  
ergonomiche, combinate  
con materiali caldi  
ed un livello di finiture  
eccellente, la rendono  
ideale per l'arredo  
degli uffici direzionali.

**EN** Its fluid lines, distinctive personality and ergonomic performance, combined with warm materials and an impeccable finish, make it the obvious choice when furnishing executive offices.

**FR** Ses lignes élancées, son caractère affirmé et ses performances ergonomiques combinés à des matériaux chaleureux et une finition irréprochable font d'elle une référence naturelle pour tout équipement de bureaux de direction.

**ES** Sus líneas rectas y a la vez esbeltas, su carácter afirmado y su ergonomía, combinados con materiales cálidos y un acabado perfecto hacen que sea ideal la opción ideal para cualquier espacio de oficina.

DIREZIONALI EXECUTIVE  
GEMINI EXECUTIVE ARMCHAIR



G15C



G4SRC







DIREZIONALI EXECUTIVE  
GEMINI EXECUTIVE ARMCHAIR

G1SC



G4SRC



G3TC



## FINITURE FINISHES

### PARTI METALLICHE METAL PARTS

Verniciato nero o cromato / Black painted or chromed / Verni couleur noir ou chrome / Acabado en negro o cromo

### PARTI IN PLASTICA PLASTIC PARTS

Nero / Black / Noir / Negro

### PARTI IN ALLUMINIO ALUMINIUM PARTS

Lucido o verniciato nero / Polished or black painted / Poli ou verni couleur noir / Pulido o acabado en negro

## ACCESSORI ACCESSORIES

### POGGIATESTA HEADREST

Imbottito / Upholstered / Rembouré / Tapizado

### BRACCIOLO ARMREST

Acciaio con appoggio in poliuretano / Steel with polyurethane pad / Acier avec soutien en polyuréthane / Acero con apoyo en poliuretano  
Forma a "T" con appoggio in poliuretano / "T" shaped with polyurethane pad / En forme de "T" avec soutien en polyuréthane / En forma de "T" con apoyo en poliuretano

### BASE GIREVOLE SWIVEL BASE

Alluminio a 5 razze / Aluminium 5 stars / Aluminium 5 branches / Aluminio de 5 radios  
Poliammide a 5 razze / Polyamide 5 stars / Polyamide 5 branches / Poliamida de 5 radios

## RIVESTIMENTI COVERINGS



tessuto  
fabric  
tissu  
tela



pelle  
leather  
cuir  
cuero

AG - AR - AL - BR - BB  
BL - CT - CE - DB - ET

EP - FP

## MISURE E VARIANTI SIZES AND VARIANTS

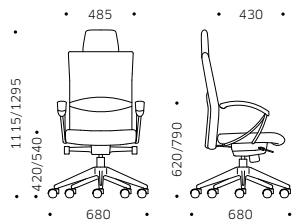

G15C

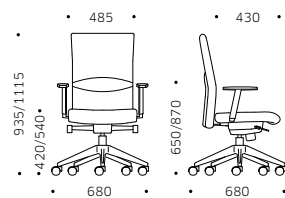

G4SRC

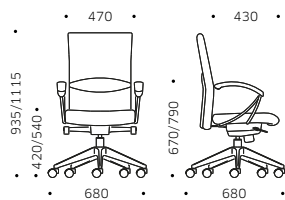

G3TC

## CERTIFICAZIONI CERTIFICATIONS

D.L. 81/08 EN 1335 Test by CATAS  
Omologazione Ministeriale in Classe 1M

## DOTAZIONI MECCANICHE TECHNICAL FEATURES

Schienale regolabile in altezza / Sedile regolabile in altezza / Sedile regolabile in profondità / Meccanismo di inclinazione sincronizzata / Meccanismo di inclinazione schienale / Dispositivo regolazione di tensione / Sistema di sicurezza antiritorno / Bracciolo regolabile in altezza / Bracciolo regolabile in larghezza

- EN Adjustable backrest / Height adjustable seat / Depth-adjustable seat / Seat and back synchronized inclination mechanism / Backrest inclination mechanism / Device for tension adjustment / Anti-return safety system / Height-adjustable armrest / Width-adjustable armrest
- FR Dossier ajustable en hauteur / Siège réglable en hauteur / Siège réglable en profondeur / Mécanisme d'inclinaison synchronisé du siège et du dossier / Mécanisme d'inclinaison du dossier / Système d'ajustement de la tension / Système de sécurité anti-retour / Accoudoir ajustable en hauteur / Accoudoir ajustable en largeur
- ES Respaldo regulable en altura / Asiento regulable en altura / Asiento regulable en profundidad / Mecanismo de inclinación de asiento y respaldo sincronizada / Mecanismo de inclinación de respaldo / Dispositivo de ajuste de tensión de oscilación / Mecanismo de seguridad anti-retorno / Reposabrazos ajustable en altura / Reposabrazos ajustable en anchura



# GEMINI GUEST CHAIR

Design by Vaghi R&D

Seduta comoda,  
dal profilo elegante  
e completamente  
rivestita, combina  
stile e personalità.  
Un'opzione che  
ben si presta come  
seduta ospiti  
o riunioni.

**EN** With a sleek profile,  
the comfortable and fully  
upholstered chair, combines  
style and versatility.  
It is a well-suited solution  
for meeting or visitor option.

**FR** Avec un profil élégant,  
la chaise, confortable  
et entièrement tapissée,  
allie style et polyvalence.  
Elle présente une option  
adaptée pour réunion  
et visiteur.

**ES** Con un perfil elegante, la silla,  
cómoda y totalmente tapizada,  
combina estilo y versatilidad.  
Presenta una opción adaptable  
para reuniones o visitas.





GE52C < G3FC A

DIREZIONALI EXECUTIVE  
GEMINI GUEST CHAIR

G3FC



GE52C





## MISURE E VARIANTI SIZES AND VARIANTS

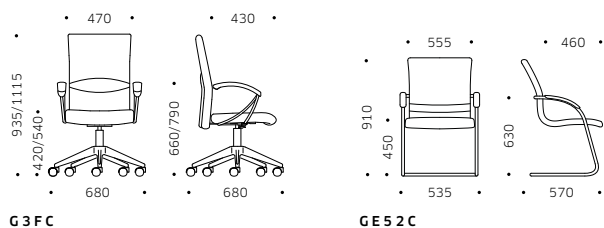

## CERTIFICAZIONI CERTIFICATIONS

**EN 16139** **EN 1022** **EN 1728** Test by CATAS  
Omologazione Ministeriale in Classe 1IM

## FINITURE FINISHES

### PARTI METALLICHE METAL PARTS

Verniciato nero o cromato / Black painted or chromed / Verni couleur noir ou chrome / Acabado en negro o cromo

### PARTI IN PLASTICA PLASTIC PARTS

Nero / Black / Noir / Negro

### PARTI IN ALLUMINIO ALUMINIUM PARTS

Lucido o verniciato nero / Polished or black painted / Poli ou verni couleur noir / Pulido o acabado en negro

## ACCESSORI ACCESSORIES

### BRACCIOLO ARMREST

Acciaio con appoggio in poliuretano / Steel with polyurethane pad / Acier avec soutien en polyuréthane / Acero con apoyo en poliuretano

### BASE GIREVOLE SWIVEL BASE

Alluminio a 5 razze / Aluminium 5 stars / Aluminium 5 branches / Aluminio de 5 radios  
Poliammide a 5 razze / Polyamide 5 stars / Polyamide 5 branches / Poliamida de 5 radios

### BASE FISSA FIXED BASE

A cantilever con braccioli, appoggio in poliuretano / Cantilever with armrests, polyurethane pad / Piètement luge avec accoudoirs, soutien en polyuréthane / Trineo con apoyabrazos, apoyo en poliuretano

## RIVESTIMENTI COVERINGS



**AG - AR - AL - BR - BB - BL - CT - CE - DB - ET**



**EP - FP**

## DOTAZIONI MECCANICHE TECHNICAL FEATURES

Sedile regolabile in altezza

- EN** Height adjustable seat
- FR** Siège réglable en hauteur
- ES** Asiento regulable en altura



# MAEVA EXECUTIVE ARMCHAIR

Design by Vaghi R&D

La soluzione ideale  
per chi cerca  
una seduta che  
non domini  
lo spazio, ma  
che s'inserisca  
senza sforzo  
e con discrezione  
negli ambienti  
lavorativi classici.

**EN** An ideal solution for people who are looking for a chair that does not dominate the room, but just fits, with effortless composure, into classical working environments.

**FR** La solution idéale pour ceux qui cherchent un siège non polarisant s'intégrant parfaitement aux environnements et ambiances classiques.

**ES** La solución ideal para quienes buscan una silla que no domine la sala, sino que simplemente encaje, con una serenidad sin esfuerzo, en entornos de trabajo clásicos.

DIREZIONALI EXECUTIVE  
MAEVA EXECUTIVE ARMCHAIR



GHS8D ^ GHSIX >







< GLSFX ^ GLSDX







DIREZIONALI EXECUTIVE  
MAEVA EXECUTIVE ARMCHAIR

GLSDX



GLSFX



TAPPEZZERIA CON CUSCINO UPHOLSTERY WITH CUSHION

GHS DX



GHS FX



GHS 8 D



GHS 6 D



TAPPEZZERIA LISCIA PLAIN UPHOLSTERY

## MODELLI DISPONIBILI AVAILABLE MODELS

### GL

Tappezzeria con cuscino / Upholstery with cushion  
Tapissierie rembourrée / Tapicería con cojín

### GH

Tappezzeria liscia / Plain upholstery  
Tapissierie simple / Tapicería simple

## MISURE E VARIANTI SIZES AND VARIANTS

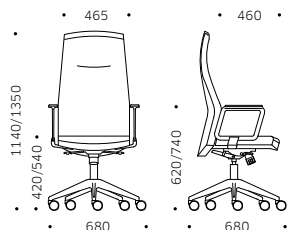

GHSDX / GLSDX

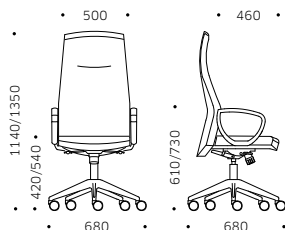

GHS8D

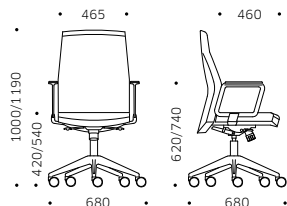

GHSFX / GLSFX

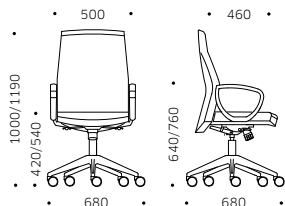

GHS6D

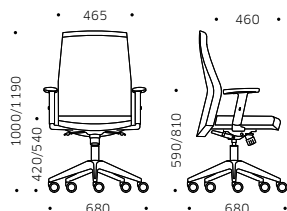

GHSIX

## FINITURE FINISHES

### PARTI METALLICHE METAL PARTS

Verniciato nero / Black painted / Verni couleur noir / Acabado en negro

### PARTI IN PLASTICA PLASTIC PARTS

Nero / Black / Noir / Negro

### PARTI IN ALLUMINIO ALUMINIUM PARTS

Lucido o verniciato nero / Polished or black painted / Poli ou verni couleur noir / Pulido o acabado en negro

## ACCESSORI ACCESSORIES

### POGGIATESTA HEADREST

Imbottito / Upholstered / Rembouré / Tapizado

### BRACCIOLO ARMREST

Alluminio con appoggio rivestito / Aluminium with upholstered pad / Aluminium avec soutien rembouré / Aluminium con apoyo tapizado  
Ad anello in poliuretano / Ring-shaped polyurethane / Accoudoirs en forme d'anneau en polyuréthane / En forma de anillo en poliuretano  
Forma a "T" con appoggio in poliuretano / "T" shaped with polyurethane pad / En forme de "T" avec soutien en polyuréthane / En forma de "T" con apoyo en poliuretano

### BASE GIREVOLE SWIVEL BASE

Alluminio a 5 razze / Aluminium 5 stars / Aluminium 5 branches / Aluminium de 5 radios  
Poliammide a 5 razze / Polyamide 5 stars / Polyamide 5 branches / Poliamida de 5 radios

## RIVESTIMENTI COVERINGS



pelle  
leather  
cuir  
cuero



tessuto  
fabric  
tissu  
tela

EP - FP

AG - AR - BR - BB - BL  
CT - CE - DB - ET

## CERTIFICAZIONI CERTIFICATIONS

D.L. 81/08 EN 1335 Test by CATAS

## DOTAZIONI MECCANICHE MECHANICAL FEATURES

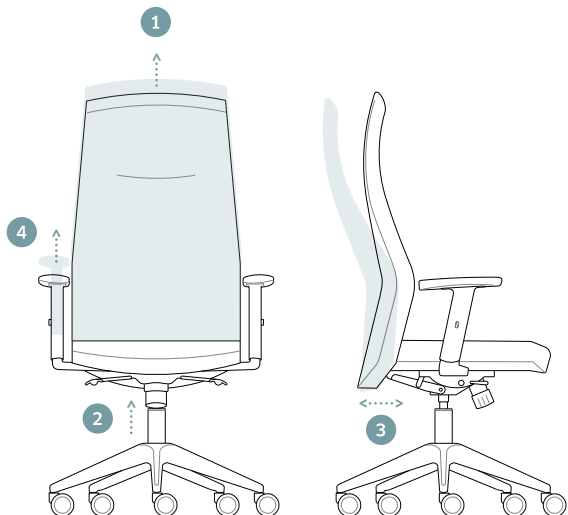

- 1 Schienale regolabile in altezza / Adjustable backrest / Dossier ajustable en hauteur / Respaldo regulable en altura
- 2 Sedile regolabile in altezza / Height adjustable seat / Siège réglable en hauteur / Asiento regulable en altura
- 3 Meccanismo di inclinazione sincronizzata / Seat and back synchronized inclination mechanism / Mécanisme d'inclinaison synchronisé du siège et du dossier / Mecanismo de inclinación de asiento y respaldo sincronizada  
Dispositivo regolazione di tensione / Device for tension adjustment / Système d'ajustement de la tension / Dispositivo de ajuste de tensión de oscilación  
Sistema di sicurezza antiritorno / Anti-return safety system / Système de sécurité anti-retour / Mecanismo de seguridad anti-retorno
- 4 Bracciolo regolabile in altezza / Height-adjustable armrest / Accoudoir ajustable en hauteur / Reposabrazos ajustable en altura



# MAEVA GUEST CHAIR

Design by Vaghi R&D

Seduta per ospiti  
dalle linee pure  
ed eleganti  
che le conferiscono  
agilità e  
dinamismo.

- EN** Guest chair with pure and elegant design. It looks flexible and dynamic with its slim-line figure.
- FR** Chaise d'accueil qui offre une esthétique épurée et élégante. La finesse de ses lignes lui confère agilité et dynamisme.
- ES** Silla para huéspedes que presenta formas de una elegancia máxima. Con su porte esbelto, refleja agilidad y espíritu deportivo.





GHOFX < GLOFX ^







DIREZIONALI EXECUTIVE  
MAEVA GUEST CHAIR

GLOFX



TAPPEZZERIA CON CUSCINO UPHOLSTERY WITH CUSHION

GHOFX



GH05X



GH2VL



TAPPEZZERIA LISCIA PLAIN UPHOLSTERY

## MODELLI DISPONIBILI AVAILABLE MODELS

### GL

Tappezzeria con cuscino  
Upholstery with cushion  
Tapisserie rembourrée  
Tapicería con cojín

### GH

Tappezzeria liscia  
Plain upholstery  
Tapisserie simple  
Tapicería simple

## MISURE E VARIANTI SIZES AND VARIANTS

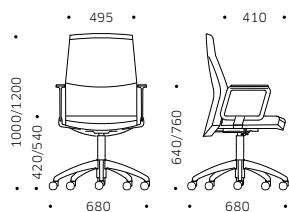

GHOFX / GLOFX

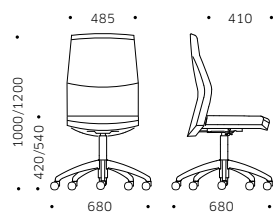

GH05X

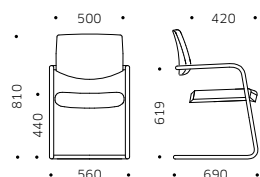

GH2VL

## CERTIFICAZIONI CERTIFICATIONS

EN 16139 EN 1022 EN 1728 Test by CATAS

## FINITURE FINISHES

### PARTI METALLICHE METAL PARTS

Verniciato nero o cromato / Black painted or chromed / Verni couleur noir ou chrome / Acabado en negro o cromo

### PARTI IN PLASTICA PLASTIC PARTS

Nero / Black / Noir / Negro

### PARTI IN ALLUMINIO ALUMINIUM PARTS

Lucido o verniciato nero / Polished or black painted / Poli ou verni couleur noir / Pulido o acabado en negro

## ACCESSORI ACCESSORIES

### BRACCIOLO ARMREST

Alluminio con appoggio rivestito / Aluminium with upholstered pad / Aluminium avec soutien rembourré / Aluminium con apoyo tapizado  
Ad anello in poliuretano / Ring-shaped polyurethane / accoudoirs en forme d'anneau en polyuréthane / En forma de anillo en poliuretano

### BASE GIREVOLE SWIVEL BASE

Alluminio a 5 razze / Aluminium 5 stars / Aluminium 5 branches / Aluminium de 5 radios  
Poliammide a 5 razze / Polyamide 5 stars / Polyamide 5 branches / Poliamida de 5 radios

### BASE FISSA FIXED BASE

A cantilever con braccioli / Cantilever with armrests / Piètement luge avec accoudoirs / Trineo con apoyabrazos

## RIVESTIMENTI COVERINGS



AG - AR - BR - BB - BL - CT - CE - DB - ET



EP - FP

## DOTAZIONI MECCANICHE TECHNICAL FEATURES

Sedile regolabile in altezza

EN Height adjustable seat

FR Siège réglable en hauteur

ES Asiento regulable en altura



# UNION EXECUTIVE ARMCHAIR

Design by Vaghi R&D

Ricercatezzazza  
di materiali e  
finiture per una  
seduta dal design  
intramontabile,  
che trova naturale  
impiego negli  
ambienti di  
lavoro che vivono  
l'atmosfera delle  
occasioni importanti.

**EN** High quality materials and finishings for a chair featuring an ageless design, which blends harmoniously executives business environments supposed to host important events.

**FR** Matériaux et finitions raffinées pour une chaise avec un design sans âge, qui trouve son utilisation naturelle dans les ambiances de travail qui vivent l'atmosphère des occasion importantes.

**ES** Materiales y acabados de alta calidad para una silla con un diseño atemporal, que encuentra su uso natural en entornos de trabajo que viven el ambiente de ocasiones importantes.

DIREZIONALI EXECUTIVE  
UNION EXECUTIVE ARMCHAIR



U3C8B ^ U3D8L >









U5C6B - U3C8B - U3C6B

DIREZIONALI EXECUTIVE  
UNION EXECUTIVE ARMCHAIR



U5C6B



U3D6L

DIREZIONALI EXECUTIVE  
UNION EXECUTIVE ARMCHAIR

U3D8X



U3D6X



BRACCIOLI E BASE IN ALLUMINIO, FINITURE CROMATE ALUMINIUM ARMREST AND BASE, CROMED FINISHES

U5C8B



U5C6B



BRACCIOLI IN ACCIAIO, FINITURE BIANCHE STEEL ARMREST, WHITE FINISHES

U3D8L



U3D6L



BRACCIOLI E BASE IN ALLUMINIO, FINITURE NERE ALUMINIUM ARMREST AND BASE, BLACK FINISHES

## MODELLI DISPONIBILI AVAILABLE MODELS

### U3

Braccioli e base in alluminio  
Aluminium armrests and base  
Accoudoirs et piètement en aluminium  
Reposabrazos y base de aluminio

### U5

Braccioli in acciaio  
Steel armrests  
Accoudoirs en acier  
Reposabrazos en acero

## MISURE E VARIANTI SIZES AND VARIANTS

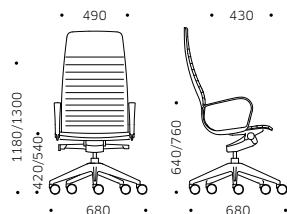

U3D8X / U3D8L

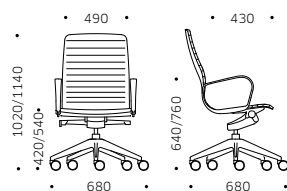

U3D6X / U3D6L

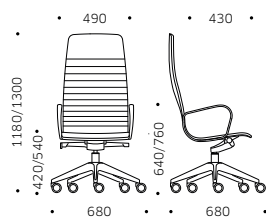

U5C8B

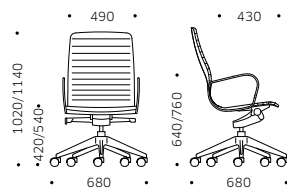

U5C6B

## CERTIFICAZIONI CERTIFICATIONS

**EN 1335** Test by CATAS  
Omologazione Ministeriale in Classe 11M

## FINITURE FINISHES

### PARTI METALLICHE METAL PARTS

Cromato, verniciato nero o bianco (RAL 9016) / Chromed, black or white painted (RAL 9016) / Chrome, verni couleur noir ou blanc (RAL 9016) / Cromo, acabado en negro o blanco (RAL 9016)

### PARTI IN PLASTICA PLASTIC PARTS

Nero / Black / Noir / Negro  
Bianco / White / Blanc / Blanco

### PARTI IN ALLUMINIO ALUMINIUM PARTS

Lucido, verniciato nero o bianco (RAL 9016) / Polished, black or white painted (RAL 9016) / Poli, verni couleur noir ou blanc (RAL 9016) / Pulido, acabado en negro o blanco (RAL 9016)

## ACCESSORI ACCESSORIES

### POGGIATESTA HEADREST

Imbottito / Upholstered / Rembouré / Tapizado

### BRACCIOLO ARMREST

Alluminio / Aluminium / Aluminium / Aluminio  
Acciaio / Steel / Acier / Acero

### BASE GIREVOLE SWIVEL BASE

Alluminio a 5 razze / Aluminium 5 stars / Aluminium 5 branches / Aluminio de 5 radios

## RIVESTIMENTI COVERINGS



AG - AR - AL - BB - CT - CE - DB - ET



EP - FP

## DOTAZIONI MECCANICHE TECHNICAL FEATURES

Sedile regolabile in altezza / Meccanismo oscillante / Dispositivo regolazione di tensione / Sistema di sicurezza antiritorno

**EN** Height adjustable seat / Tilt mechanism / Device for tension adjustment / Anti-return safety system

**FR** Siège réglable en hauteur / Mécanisme pivotant / Système d'ajustement de la tension / Système de sécurité anti-retour

**ES** Asiento regulable en altura / Mecanismo oscilante / Dispositivo de ajuste de tensión de oscilación / Mecanismo de seguridad anti-retorno



# UNION GUEST CHAIR

Design by Vaghi R&D

Discreta,  
ma con un  
tocco di brio,  
s'inserisce  
con facilità  
sia in ufficio  
che a casa.

**EN** Discreet, but with a fresh breeze, it is suitable for both office and residential environment.

**FR** Un siège discret dont l'esthétique épurée s'intègre parfaitement dans les bureaux ou à la maison.

**ES** Discreta pero con nuevos aires, preparada por igual para los espacios de oficinas y los lugares de trabajo en el hogar.







U504B - U54GL - U51DC - U504L < U306L ^

DIREZIONALI EXECUTIVE  
UNION GUEST CHAIR



U32TN



U52QN



U53GN



U51DC





U51PB - U52QN - U5SPB - U32TB

DIREZIONALI EXECUTIVE  
UNION GUEST CHAIR

U32TN



BASE FISSA IN ALLUMINIO ALUMINIUM FIXED BASE

U306L



U504L



BASE GIREVOLE ED ELEVABILE IN ALLUMINIO ALUMINIUM SWIVEL LIFTING BASE

U54GL



U53GN



U51DC



BASE GIREVOLE SWIVEL BASE

U52QN



U51PB



U55PB



BASE FISSA IN ACCIAIO STEEL FIXED BASE

## MODELLI DISPONIBILI AVAILABLE MODELS

### U3

Girevole, braccioli e base in alluminio / Swivel, aluminium armrests and base / Pivotant, accoudoirs et piètement en aluminium / Giratoria, reposabrazos y base de aluminio  
Base fissa in alluminio / Aluminium fixed base / Base fixe en aluminium / Base fija de aluminio

### U5

Girevole, braccioli in acciaio / Swivel, steel armrests / Pivotent, accoudoirs en acier / Giratoria, reposabrazos en acero  
Base fissa in acciaio / Steel fixed base / Base fixe en acier / Base fija de acero

## MISURE E VARIANTI SIZES AND VARIANTS

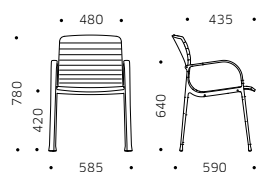

U32TB / U32TN

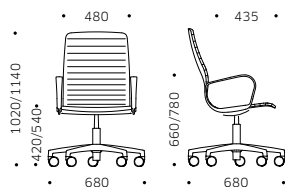

U306L

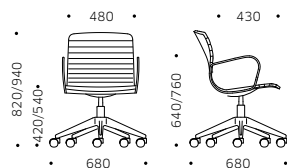

U504L

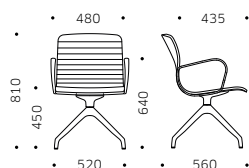

U54GL

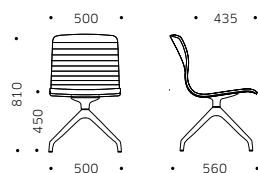

U53GN

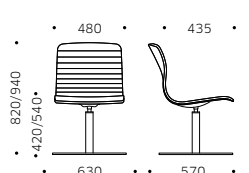

U51DC

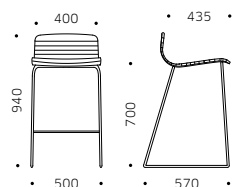

U55PB

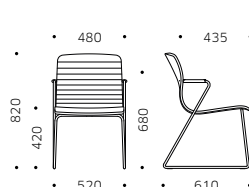

U52QN

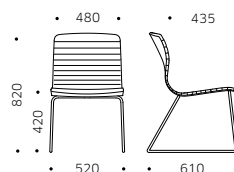

U51PB

## CERTIFICAZIONI CERTIFICATIONS

EN 16139 EN 1022 EN 1728 Test by CATAS  
Omologazione Ministeriale in Classe 1IM

## FINITURE FINISHES

### PARTI METALLICHE METAL PARTS

Cromato, verniciato nero o bianco (RAL 9016) / Chromed, black or white painted (RAL 9016) / Chrome, verni couleur noir ou blanc (RAL 9016) / Cromo, acabado en negro o blanco (RAL 9016)

### PARTI IN PLASTICA PLASTIC PARTS

Nero o bianco / Black or white / Noir ou blanc / Negro o blanco

### PARTI IN ALLUMINIO ALUMINIUM PARTS

Lucido, verniciato nero o bianco (RAL 9016) / Polished, black or white painted (RAL 9016) / Poli, verni couleur noir ou blanc (RAL 9016) / Pulido, acabado en negro o blanco (RAL 9016)

## ACCESSORI ACCESSORIES

### BRACCIOLO ARMREST

Alluminio / Aluminium / Aluminium / Aluminio  
Acciaio / Steel / Acier / Acero

### BASE GIREVOLE SWIVEL BASE

Alluminio a 5 razze / Aluminium 5 stars / Aluminium 5 branches / Aluminio de 5 radios

Alluminio a 4 razze / Aluminium 4 spoke / Aluminium 4 branches / Aluminio de 4 radios

Poliamide a 4 razze / Polyamide 4 stars / Polyamide 4 branches / Poliamida de 4 radios

A disco in acciaio inox / Stainless steel disk / Disk en acier inoxydable / Disco en acero inoxidable

### BASE FISSA FIXED BASE

Alluminio a 4 gambe / Aluminium 4 legs / Aluminium 4 pieds / Aluminio de 4 patas

Acciaio a slitta / Steel sledge shaped / Traîneau en acier / Trineo de scero

## RIVESTIMENTI COVERINGS



tessuto  
fabric  
tissu  
tela

AG - AR - AL - BB - CT - CE - DB - ET



pelle  
leather  
cuir  
cuero

EP - FP

## DOTAZIONI MECCANICHE TECHNICAL FEATURES

Sedile regolabile in altezza / Sedile girevole con colonna autoallineante / Meccanismo oscillante armonico

EN Height adjustable seat / Swivel seat with self-aligning column / Tilt mechanism

FR Siège réglable en hauteur / Siège pivotant avec retour automatique / Mécanisme pivotant

ES Asiento regulable en altura / Asiento giratorio con columna de alineación automática / Mecanismo oscilante





# AQABA EXECUTIVE ARMCHAIR

Design by Vaghi R&D

Dimensioni,  
comfort e  
prestazioni sono  
le parole chiave  
di questa serie  
di sedute  
direzionali che  
si caratterizzano  
per l'ottimo  
rapporto  
prezzo/qualità.

**EN** Size, comfort and performance are the key words to describe this range of value for money executive chairs.

**FR** Volume, confort et performance sont les maîtres-mots de cette gamme de fauteuils de direction au prix très étudié.

**ES** Volumen, comodidad y rendimiento son las palabras clave de esta nueva gama de sillones de dirección con precio muy estudiado.

DIREZIONALI EXECUTIVE  
AQABA EXECUTIVE ARMCHAIR



AQCFX ^ AQCDX >



DIREZIONALI EXECUTIVE  
AQABA EXECUTIVE ARMCHAIR

AQCDX



AQCFX



## MISURE E VARIANTI SIZES AND VARIANTS

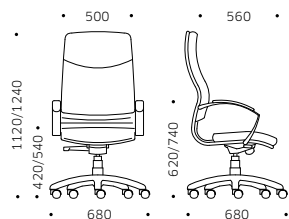

AQCDX

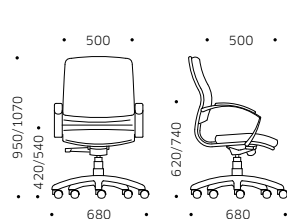

AQCFX

## CERTIFICAZIONI CERTIFICATIONS

EN 1335 Test by CATAS

## FINITURE FINISHES

### PARTI METALLICHE METAL PARTS

Verniciato nero / Black painted / Verni couleur noir / Acabado en negro

### PARTI IN PLASTICA PLASTIC PARTS

Nero / Black / Noir / Negro

### PARTI IN ALLUMINIO ALUMINIUM PARTS

Lucido / Polished / Poli / Pulido

## ACCESSORI ACCESSORIES

### POGGIATESTA HEADREST

Imbottito / Upholstered / Rembouré / Tapizado

### BRACCIOLO ARMREST

Alluminio con appoggio rivestito / Aluminium with upholstered pad / Aluminium avec soutien rembouré / Aluminium con apoyo tapizado

### BASE GIREVOLE SWIVEL BASE

Alluminio a 5 razze / Aluminium 5 stars / Aluminium 5 branches / Aluminium de 5 radios

## RIVESTIMENTI COVERINGS



tessuto  
fabric  
tissu  
tela

AG - AR - AL - BR - BB - BL - CT - CE - DB - ET



pelle  
leather  
cuir  
cuero

EP - FP

## DOTAZIONI MECCANICHE TECHNICAL FEATURES

Sedile regolabile in altezza / Meccanismo oscillante / Dispositivo regolazione di tensione / Sistema di sicurezza antiritorno

EN Height adjustable seat / Tilt mechanism / Device for tension adjustment / Anti-return safety system

FR Siège réglable en hauteur / Mécanisme pivotant / Système d'ajustement de la tension / Système de sécurité anti-retour

ES Asiento regulable en altura / Mecanismo oscilante / Dispositivo de ajuste de tensión de oscilación / Mecanismo de seguridad anti-retorno



# AQABA GUEST CHAIR

Design by Vaghi R&D

Seduta ospiti  
dalle linee  
contemporanee  
che offre  
un comfort  
rassicurante.

**EN** Guest chair with  
a modern design,  
offering a reassuring  
comfort.

**FR** Chaise d'accueil avec  
des lignes nettes  
et contemporaines  
qui offre un confort  
rassurant.

**ES** Silla de recepción  
con líneas nítidas  
y contemporáneas  
que ofrece comodidad  
reconfortante.







AQ2VL < AQOFX ^

DIREZIONALI EXECUTIVE  
AQABA GUEST CHAIR

AQOFX



AQ2VL



## MISURE E VARIANTI SIZES AND VARIANTS

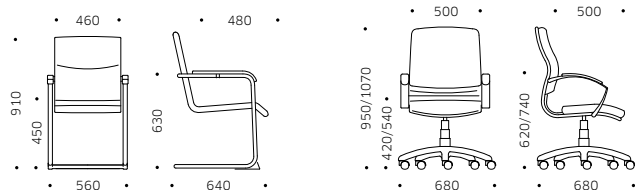

A Q2VL

A Q0FX

## CERTIFICAZIONI CERTIFICATIONS

EN 16139 EN 1022 EN 1728 Test by CATAS

## FINITURE FINISHES

### PARTI METALLICHE METAL PARTS

Verniciato nero o cromato / Black painted or chromed / Verni couleur noir ou chrome / Acabado en negro o cromo

### PARTI IN PLASTICA PLASTIC PARTS

Nero / Black / Noir / Negro

### PARTI IN ALLUMINIO ALUMINIUM PARTS

Lucido / Polished / Poli / Pulido

## ACCESSORI ACCESSORIES

### BRACCIOLO ARMREST

Alluminio con appoggio rivestito / Aluminium with upholstered pad / Aluminium avec soutien rembouré / Aluminio con apoyo tapizado

### BASE GIREVOLE SWIVEL BASE

Alluminio a 5 razze / Aluminium 5 stars / Aluminium 5 branches / Aluminio de 5 radios

### BASE FISSA FIXED BASE

A cantilever con braccioli, appoggio rivestito / Cantilever with armrests, upholstered pad / Piètement luge avec accoudoirs, soutien rembouré / Trineo con apoyabrazos, apoyo tapizado

## RIVESTIMENTI COVERINGS



tessuto  
fabric  
tissu  
tela

AG - AR - AL - BR - BB - BL - CT - CE - DB - ET



pelle  
leather  
cuir  
cuero

EP - FP

## DOTAZIONI MECCANICHE TECHNICAL FEATURES

Sedile regolabile in altezza

EN Height adjustable seat

FR Siège réglable en hauteur

ES Asiento regulable en altura



# KIRUNA EXECUTIVE ARMCHAIR

Design by Vaghi R&D

Questa seduta  
direzionale,  
dall'eleganza  
sobria e senza  
tempo, vanta  
proporzioni  
generose  
ed esprime  
una personalità  
potente.

- EN** This executive chair has a timeless, understated elegance, boasting generous proportions and is imbued with a powerful personality.
- FR** Ce siège de direction a l'allure intemporelle doté de volumes importants, dégageant une forte personnalité tout en reflétant élégance et sobriété.
- ES** Este sillón de dirección es un objeto con una imagen atemporal, con grandes volúmenes, con fuerte personalidad, otorgándole elegancia y sobriedad.





KIDDX - KIDFX < KIDFX ^







DIREZIONALI EXECUTIVE  
KIRUNA EXECUTIVE ARMCHAIR

KIDDX



KIDFX



SCOCCA RIVESTITA, PROFILO GRIGIO UPHOLSTERED SHELL, GREY PROFILED EDGE

KLDDX



KLDFX



SCOCCA RIVESTITA, PROFILO IN TINTA UPHOLSTERED SHELL, PLAIN PROFILED EDGE

## MODELLI DISPONIBILI AVAILABLE MODELS

### KI

Scocca rivestita, profilo grigio  
Upholstered shell, grey profiled edge  
Coque rembouré, profil gris  
Cuerpo tapizado, perfil gris

### KL

Scocca rivestita, profilo in tinta  
Upholstered shell, plain profiled edge  
Coque rembouré, profil dans teinte  
Cuerpo tapizado, perfil en tinte

## MISURE E VARIANTI SIZES AND VARIANTS

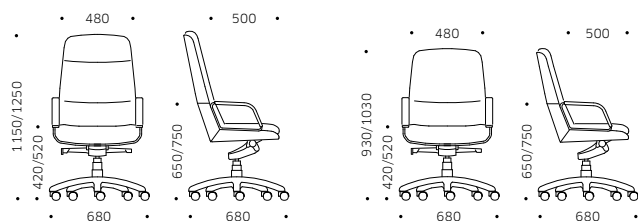

KIDDX / KLDDX

KIDFX / KLDFX

## CERTIFICAZIONI CERTIFICATIONS

EN 1335 Test by CATAS

## FINITURE FINISHES

### PARTI METALLICHE METAL PARTS

Verniciato nero / Black painted / Verni couleur noir / Acabado en negro

### PARTI IN PLASTICA PLASTIC PARTS

Nero / Black / Noir / Negro

### PARTI IN ALLUMINIO ALUMINIUM PARTS

Lucido o verniciato nero / Polished or black painted / Poli ou verni couleur noir / Pulido o acabado en negro

## ACCESSORI ACCESSORIES

### POGGIATESTA HEADREST

Imbottito / Upholstered / Rembouré / Tapizado

### BRACCIOLO ARMREST

Alluminio con appoggio rivestito / Aluminium with upholstered pad / Aluminium avec soutien rembouré / Aluminium con apoyo tapizado

### BASE GIREVOLE SWIVEL BASE

Alluminio a 5 razze / Aluminium 5 stars / Aluminium 5 branches / Aluminium de 5 radios

## RIVESTIMENTI COVERINGS



tessuto  
fabric  
tissu  
tela

AG - AR - BR - BB - BL - CT - CE - DB - ET



pelle  
leather  
cuir  
cuero

EP - FP

## DOTAZIONI MECCANICHE TECHNICAL FEATURES

Sedile regolabile in altezza / Meccanismo oscillante / Dispositivo regolazione di tensione / Sistema di sicurezza antiritorno

EN Height adjustable seat / Tilt mechanism / Device for tension adjustment / Anti-return safety system

FR Siège réglable en hauteur / Mécanisme pivotant / Système d'ajustement de la tension / Système de sécurité anti-retour

ES Asiento regulable en altura / Mecanismo oscilante / Dispositivo de ajuste de tensión de oscilación / Mecanismo de seguridad anti-retorno



# KIRUNA GUEST CHAIR

Design by Vaghi R&D

I contorni  
morbidamente  
scolpiti  
e le generose  
proporzioni  
promettono  
un ottimo  
comfort  
di seduta.

**EN** The gently sculpted contours and generous proportions promise outstanding sitting comfort.

**FR** Ses contours délicatement sculptés et ses proportions généreuses promettent un confort optimal.

**ES** Los contornos suavemente esculpidos y las proporciones generosas prometen una óptima comodidad.

DIREZIONALI EXECUTIVE  
KIRUNA GUEST CHAIR



KI2VL ^ KIOFX >



DIREZIONALI EXECUTIVE  
KIRUNA GUEST CHAIR

K10FX



K103Z



K12VL



SCocca RIVESTITA, PROFILO GRIGIO UPHOLSTERED SHELL, GREY PROFILED EDGE

KLOFX



SCocca RIVESTITA, PROFILO IN TINTA UPHOLSTERED SHELL, PLAIN PROFILED EDGE



## MODELLI DISPONIBILI AVAILABLE MODELS

### KI

Scocca rivestita, profilo grigio  
Upholstered shell, grey profiled edge  
Coque rembouré, profil gris  
Cuerpo tapizado, perfil gris

### KL

Scocca rivestita, profilo in tinta  
Upholstered shell, plain profiled edge  
Coque rembouré, profil dans teinte  
Cuerpo tapizado, perfil en tinte

## MISURE E VARIANTI SIZES AND VARIANTS

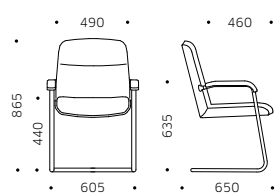

KI2VL

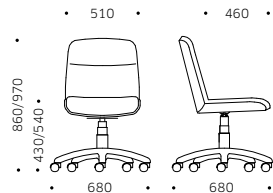

KI03Z

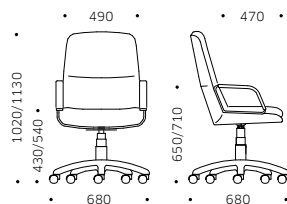

KLOFX / KI0FX

## CERTIFICAZIONI CERTIFICATIONS

EN 16139 EN 1022 EN 1728 Test by CATAS

## FINITURE FINISHES

### PARTI METALLICHE METAL PARTS

Verniciato nero o cromato / Black painted or chromed / Verni couleur noir ou chrome / Acabado en negro o cromo

### PARTI IN PLASTICA PLASTIC PARTS

Nero / Black / Noir / Negro

### PARTI IN ALLUMINIO ALUMINIUM PARTS

Lucido o verniciato nero / Polished or black painted / Poli ou verni couleur noir / Pulido o acabado en negro

## ACCESSORI ACCESSORIES

### BRACCIOLO ARMREST

Alluminio con appoggio rivestito / Aluminium with upholstered pad / Aluminium avec soutien rembouré / Aluminium con apoyo tapizado

### BASE GIREVOLE SWIVEL BASE

Alluminio a 5 razze / Aluminium 5 stars / Aluminium 5 branches / Aluminio de 5 radios

### BASE FISSA FIXED BASE

A cantilever con braccioli, appoggio rivestito / Cantilever with armrests, upholstered pad / Piètement luge avec accoudoirs, soutien rembouré / Trineo con apoyabrazos, apoyo tapizado

## RIVESTIMENTI COVERINGS



AG - AR - BR - BB - BL - CT - CE - DB - ET



EP - FP

## DOTAZIONI MECCANICHE TECHNICAL FEATURES

Sedile regolabile in altezza

EN Height adjustable seat

FR Siège réglable en hauteur

ES Asiento regulable en altura

# OPERATIVE TASK

- 143 ASSIA EV
- 151 ASSIA CL
- 159 EXPO LIGHT LR/LI
- 167 EXPO LIGHT QX/LX E IQ/IX
- 183 BURSA RETE EVOLUTION WHITE
- 191 BURSA RETE EVOLUTION BLACK
- 199 BURSA RETE
- 211 AVILA BURSA
- 219 MOREA COMFORT
- 235 MALTA
- 241 LYBRA
- 247 SULKY



# ASSIA EV ADVANCED SWIVEL CHAIR

Design by Vaghi R&D

Assia EV  
offre molteplici  
funzioni  
ergonomiche di  
facile regolazione,  
che permettono  
una postura sempre  
sana e confortevole  
anche in caso  
di utilizzo da parte  
di utenti diversi.

**EN** Assia Evo has various ergonomic functions easy to adjust, ensuring that alternating users will always have a healthy and comfortable sitting posture.

**FR** Assia Evo offre une grande facilité de réglage qui permet de profiter pleinement de son ergonomie et de ses fonctionnalités, en garantissant un confort bénéfique à tous ses utilisateurs.

**ES** Assia Evo ofrece el ajuste sencillo de las funciones ergonómicas, lo que permite mantener un confort saludable incluso al cambiar de usuarios.

OPERATIVE TASK  
ASSIA EV ADVANCED SWIVEL CHAIR



EBTID + ELG1D



ENP5D + ELG1D



ENSZD + ELG1D







OPERATIVE TASK  
ASSIA EV ADVANCED SWIVEL CHAIR

EBTZD + ELG1D



EBTID + ELG1D



EBP5D + ELG1D



PLASTICA BIANCA WHITE PLASTIC

ENSZD + ELG1D



ENSID + ELG1D



ENP5D + ELG1D



PLASTICA NERA BLACK PLASTIC

## AVVERTENZA NOTICE

Supporto lombare regolabile in polipropilene : a richiesta  
Polypropylene adjustable lumbar support: available on demand  
Support lombaire réglable en polypropylène: sur demande  
Soporte lumbar ajustable en polipropileno: opcional

## MODELLI DISPONIBILI AVAILABLE MODELS

### EN

Plastica nera / Black plastic / Plastique noir / Plástico negro

### EB

Plastica bianca / White plastic / Plastique blanc / Plástico blanco

## MISURE E VARIANTI SIZES AND VARIANTS

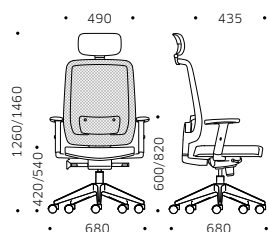

EBTZD / ENSZD + ELG1D

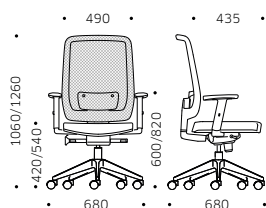

EBTID / ENSID + ELG1D

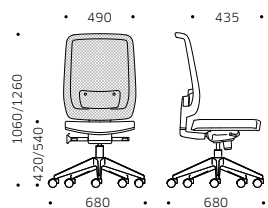

EBP5D / ENP5D + ELG1D

## DOTAZIONI MECCANICHE MECHANICAL FEATURES

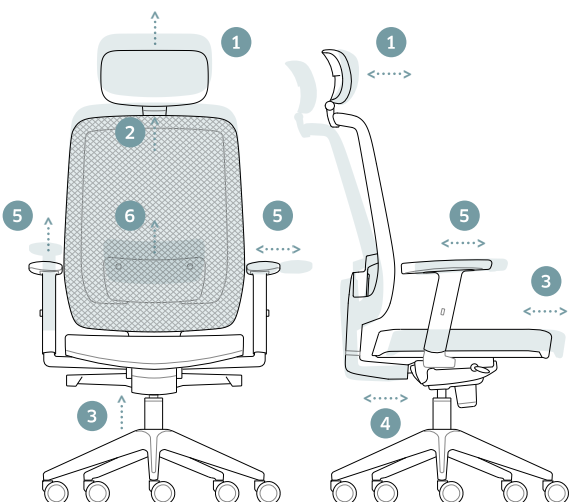

## FINITURE FINISHES

### PARTI METALLICHE METAL PARTS

Verniciato nero / Black painted / Verni couleur noir / Acabado en negro

### PARTI IN ALLUMINIO ALUMINIUM PARTS

Lucido, verniciato nero o bianco (RAL 9016) / Polished, black or white (RAL 9016) painted / Poli, verni couleur noir, ou blanc (RAL 9016) / Pulido, acabado en negro o blanco (RAL 9016)

### PARTI IN PLASTICA PLASTIC PARTS

Nero o grigio (RAL 7047) o bianco (RAL 9003) / Black or grey (RAL 7047) or white (RAL 9003) / Noir ou gris (RAL 7047) ou blanc (RAL 9003) / Negro o gris (RAL 7047) o blanco (RAL 9003)

## ACCESSORI ACCESSORIES

### POGGIATESTA HEADREST

Imbottito / Upholstered / Rembouré / Tapizado

### BRACCIOLO ARMREST

Forma a "T" / "T" shaped / En forme de "T" / En forma de "T"

### BASE GIREVOLE SWIVEL BASE

Alluminio a 5 razze / Aluminium 5 stars / Aluminium 5 branches / Aluminio de 5 radios  
Poliamide a 5 razze / Polyamide 5 stars / Polyamide 5 branches / Poliamida de 5 radios

## RIVESTIMENTI COVERINGS



rete  
netting  
réseau  
red



tessuto  
fabric  
tissu  
tela

RE

AG - AR - AL - BR - BB - BL - CR

CT - CE - DB - ET

## CERTIFICAZIONI CERTIFICATIONS

D.L. 81/08 EN 1335 Test by CATAS

- 1 Poggiatesta regolabile in altezza e inclinazione / Tilting headrest, height adjustable headrest / Appuie-tête inclinable et réglable en hauteur / Apoyacabezas regulable en inclinación y altura
- 2 Schienale regolabile in altezza / Tilting, height adjustable lumbar support / Support lombaire inclinable et ajustable en hauteur / Soporte lumbar regulable en inclinación y altura
- 3 Sedile regolabile in altezza e profondità / Height and depth adjustable seat / Siège réglable en hauteur et en profondeur / Asiento regulable en altura y en profundidad
- 4 Meccanismo di inclinazione sincronizzata / Seat and back synchronized inclination mechanism / Mécanisme d'inclinaison synchronisé du siège et du dossier / Mecanismo de inclinación de asiento y respaldo sincronizada  
Dispositivo regolazione di tensione / Device for tension adjustment / Système d'ajustement de la tension / Dispositivo de ajuste de tensión de oscilación  
Sistema di sicurezza antiritorno / Anti-return safety system / Système de sécurité anti-retour / Mecanismo de seguridad anti-retorno
- 5 Bracciolo regolabile in altezza, larghezza, profondità, con appoggio orientabile / Height, width, depth-adjustable armrest, pivoting arm-cap / Accoudoir ajustable en hauteur, largeur, profondeur avec support pivotant / Reposabrazos ajustable en altura, anchura, profundidad con apoyobrazo orientable
- 6 Supporto lombare regolabile in altezza / Height adjustable lumbar support / Support lombaire ajustable en hauteur / Soporte lumbar regulable en altura



# ASSIA CL ADVANCED SWIVEL CHAIR

Design by Vaghi R&D

Questa serie di sedute da lavoro si caratterizza per il design dalle linee morbide ed arrotondate evocando comfort, semplicità e benessere.

- EN** This range of operator chairs features a pleasing, softly rounded shape that evokes simplicity, comfort and well-being.
- FR** Ces gamme de sièges opérateurs se caractérise par des lignes soft et organiques, inspirant douceur, bien-être et simplicité.
- ES** Esta gama de sillas operativas se caracteriza por líneas suaves y orgánicas que inspiran confort, bienestar y sencillez.



Istruzioni d'uso /  
User manual



Configura la tua seduta /  
Set up your chair





A2TVL < A1TVX ^

OPERATIVE TASK  
ASSIA CL ADVANCED SWIVEL CHAIR



A2TZL





A2TVL

OPERATIVE TASK

# ASSIA CL ADVANCED SWIVEL CHAIR

A2TZL



A2TVL



PLASTICA NERA BLACK PLASTIC

A1TVX



A1T5X



PLASTICA GRIGIA GREY PLASTIC

## MODELLI DISPONIBILI AVAILABLE MODELS

### A2

Plastica nera / Black plastic / Plastique noir / Plástico negro

### A1

Plastica grigia / Grey plastic / Plastique gris / Plástico gris

## MISURE E VARIANTI SIZES AND VARIANTS

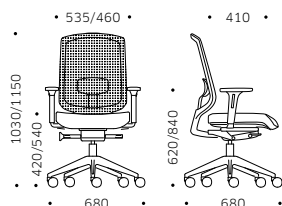

A1TVX / A2TVL

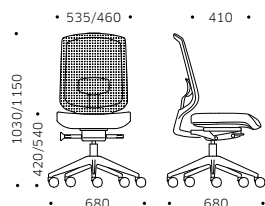

A1T5X

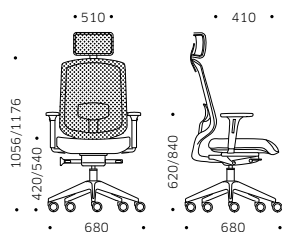

A2TZL

## CERTIFICAZIONI CERTIFICATIONS

D.L. 81/08 EN 1335 Test by CATAS

## DOTAZIONI MECCANICHE MECHANICAL FEATURES

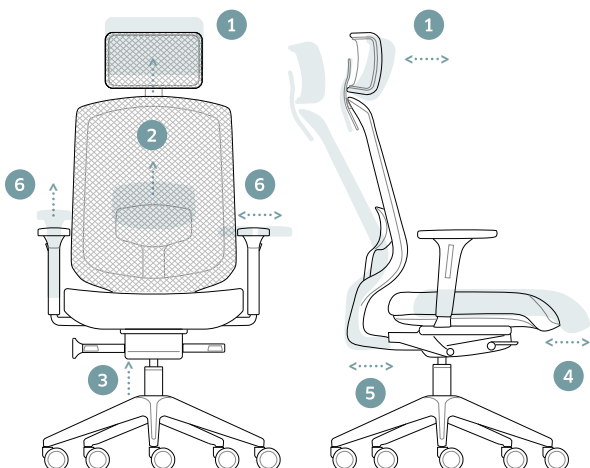

- 1 Poggiatesta regolabile in altezza e inclinazione / Tilting headrest, height adjustable headrest / Appuie-tête inclinable et réglable en hauteur / Apoyacabezas regulable en inclinación y altura
- 2 Supporto lombare regolabile in altezza / Height adjustable lumbar support / Support lombaire ajustable en hauteur / Soporte lumbar regulable en altura
- 3 Sedile regolabile in altezza / Height adjustable seat / Siège réglable en hauteur / Asiento regulable en altura
- 4 Sedile regolabile in profondità / Depth-adjustable seat / Siège réglable en profondeur / Asiento regulable en profundidad
- 5 Meccanismo di inclinazione sincronizzata / Seat and back synchronized inclination mechanism / Mécanisme d'inclinaison synchronisé du siège et du dossier / Mecanismo de inclinación de asiento y respaldo sincronizada  
Dispositivo regolazione di tensione / Device for tension adjustment / Système d'ajustement de la tension / Dispositivo de ajuste de tensión de oscilación
- 6 Bracciolo regolabile in altezza e larghezza / Height and width-adjustable armrest / Accoudoir ajustable en hauteur et largeur / Reposabrazos ajustable en altura y anchura

## FINITURE FINISHES

### PARTI METALLICHE METAL PARTS

Verniciato nero / Black painted / Verni couleur noir / Acabado en negro

### PARTI IN PLASTICA PLASTIC PARTS

Nero o grigio (RAL 7047) / Black or grey (RAL 7047) / Noir ou gris (RAL 7047) / Negro o gris (RAL 7047)

### PARTI IN ALLUMINIO ALUMINIUM PARTS

Lucido, verniciato nero o argento (RAL 9006) / Polished, black or silver (RAL 9006) painted / Poli, verni couleur noir, ou argent (RAL 9006) / Pulido, acabado en negro o plateado (RAL 9006)

## ACCESSORI ACCESSORIES

### POGGIATESTA HEADREST

In rete / Mesh / Maille / De malla

### BRACCIOLO ARMREST

Forma a "T" con appoggio in poliuretano / "T" shaped with polyurethane pad / En forme de "T" avec soutien en polyuréthane / En forma de "T" con apoyo en poliuretano

### BASE GIREVOLE SWIVEL BASE

Alluminio a 5 razze / Aluminium 5 stars / Aluminium 5 branches / Aluminio de 5 radios  
Poliamide a 5 razze / Polyamide 5 stars / Polyamide 5 branches / Poliamida de 5 radios

## RIVESTIMENTI COVERINGS



rete  
netting  
réseau  
red



tessuto  
fabric  
tissu  
tela

RE

AG - AR - AL - BR - BB - BL  
CR - CT - CE - DB - ET



# EXPO LIGHT LR/LI ADVANCED SWIVEL CHAIR

Design by Vaghi R&D

Queste sedute da lavoro, dal design rassicurante, equilibrato ed efficiente, sono il prodotto ideale per le lunghe giornate lavorative.

**EN** These operator chairs, with their reassuring, well-balanced, and efficient design, are the perfect partner during the long working day.

**FR** Rassurants, équilibrés et efficaces, ces sièges opérateur ont été dessinées et conçus pour en faire des partenaires parfaits pour les longues heures de travail.

**ES** Acogedoras y equilibradas, estas sillas operativas han sido diseñadas para actuar como aliadas perfectas para los largos días de trabajo.





LIS5X - LRSMX - LRSXX < LISMX ^

OPERATIVE TASK  
EXPO LIGHT LR/LI ADVANCED SWIVEL CHAIR



LISXX



LRSMX





PISXX

OPERATIVE TASK  
EXPO LIGHT LR/LI ADVANCED SWIVEL CHAIR

PRSXX



LRSXX



LRSMX



LRS5X



SCHIENALE IN RETE, FINITURE IN ALLUMINIO LUCIDO MESH BACKREST, POLISHED ALUMINIUM FINISHES

PISXX



LISXX



LISMX



LIS5X



SCHIENALE IMBOTTITO, FINITURE IN ALLUMINIO LUCIDO UPHOLSTERED BACKREST, POLISHED ALUMINIUM FINISHES

## MODELLI DISPONIBILI AVAILABLE MODELS

### LR

Schienale in rete e finiture in alluminio lucido / mesh backrest and polished aluminium finishes / Dossier en maille et finitions en aluminium poli / Respaldo de malla y acabado en aluminio pulido

### LI

Schienale imbottito e finiture in alluminio lucido / padded backrest and polished aluminium finishes / Dossier rembouré et finitions en aluminium poli / Respaldo tapizado y acabado en aluminio pulido

## MISURE E VARIANTI SIZES AND VARIANTS

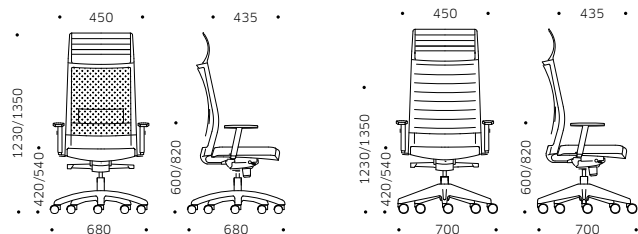

LRSXX / PRSXX

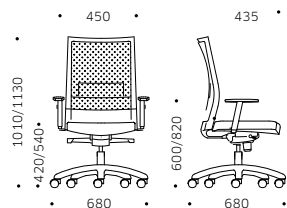

LISXX / PISXX

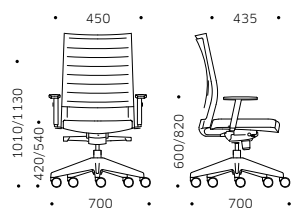

LRSMX

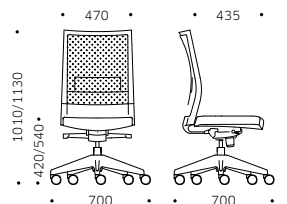

LISMX

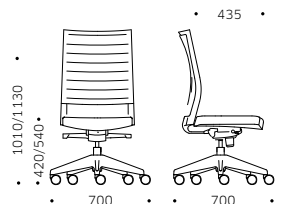

LXS5L

LIS5X

## DOTAZIONI MECCANICHE MECHANICAL FEATURES

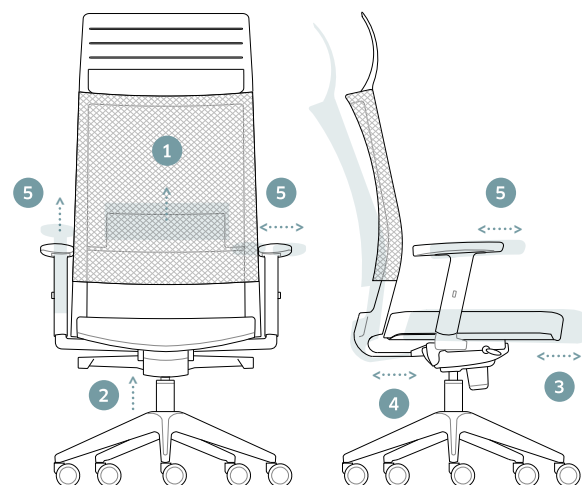

- 1 Appoggio lombare regolabile in altezza / Height adjustable lumbar support / Réglable en hauteur, support lombaire / Soporte lumbar regulable en altura
- 2 Sedile regolabile in altezza / Height adjustable seat / Siège réglable en hauteur / Asiento regulable en altura
- 3 Sedile regolabile in profondità / Depth-adjustable seat / Siège réglable en profondeur / Asiento regulable en profundidad
- 4 Meccanismo di inclinazione sincronizzata / Seat and back synchronized inclination mechanism / Mécanisme d'inclinaison synchronisé du siège et du dossier / Mecanismo de inclinación de asiento y respaldo sincronizada  
Dispositivo regolazione di tensione / Device for tension adjustment / Système d'ajustement de la tension / Dispositivo de ajuste de tensión de oscilación  
Sistema di sicurezza antiritorno / Anti-return safety system / Système de sécurité anti-retour / Mecanismo de seguridad anti-retorno
- 5 Bracciolo regolabile in altezza, larghezza, profondità, con appoggio orientabile / Height, width, depth-adjustable armrest, pivoting arm-cap / Accoudoir ajustable en hauteur, largeur, profondeur avec support pivotant / Reposabrazos ajustable en altura, anchura, profundidad con apoyobrazo orientable

## FINITURE FINISHES

### PARTI METALLICHE METAL PARTS

Verniciato nero / Black painted / Verni couleur noir / Acabado en negro

### PARTI IN PLASTICA PLASTIC PARTS

Nero / Black / Noir / Negro

### PARTI IN ALLUMINIO ALUMINIUM PARTS

Lucido / Polished / Poli / Pulido

## ACCESSORI ACCESSORIES

### POGGIATESTA HEADREST

Imbottito o polipropilene / Upholstered or polypropylene / Rembouré ou polypropylène / Tapizado o polipropileno

### BRACCIOLO ARMREST

Forma a "T" / "T" shaped / En forme de "T" / En forma de "T"

### BASE GIREVOLE SWIVEL BASE

Alluminio a 5 razze / Aluminium 5 stars / Aluminium 5 branches / Aluminio de 5 radios

## RIVESTIMENTI COVERINGS



rete  
netting  
réseau  
red

RE - RS



pelle  
leather  
cuir  
cuero

EP - FP



tessuto  
fabric  
tissu  
tela

AG - AR - AL - BR

BB - BL - CR - CT

CE - DB - ET

## CERTIFICAZIONI CERTIFICATIONS

D.L. 81/08 EN 1335 Test by CATAS

Omologazione Ministeriale in Classe 1IM - Solo per serie con schienale rivestito (modelli LI)



# EXPO LIGHT QX/LX E IQ/IX ADVANCED SWIVEL CHAIR

Design by Vaghi R&D

Queste sedute da lavoro, dal design rassicurante, equilibrato ed efficiente, sono il prodotto ideale per le lunghe giornate lavorative.

**EN** These operator chairs, with their reassuring, well-balanced, and efficient design, are the perfect partner during the long working day.

**FR** Rassurants, équilibrés et efficaces, ces sièges opérateur ont été dessinées et conçus pour en faire des partenaires parfaits pour les longues heures de travail.

**ES** Acogedoras y equilibradas, estas sillas operativas han sido diseñadas para actuar como aliadas perfectas para los largos días de trabajo.

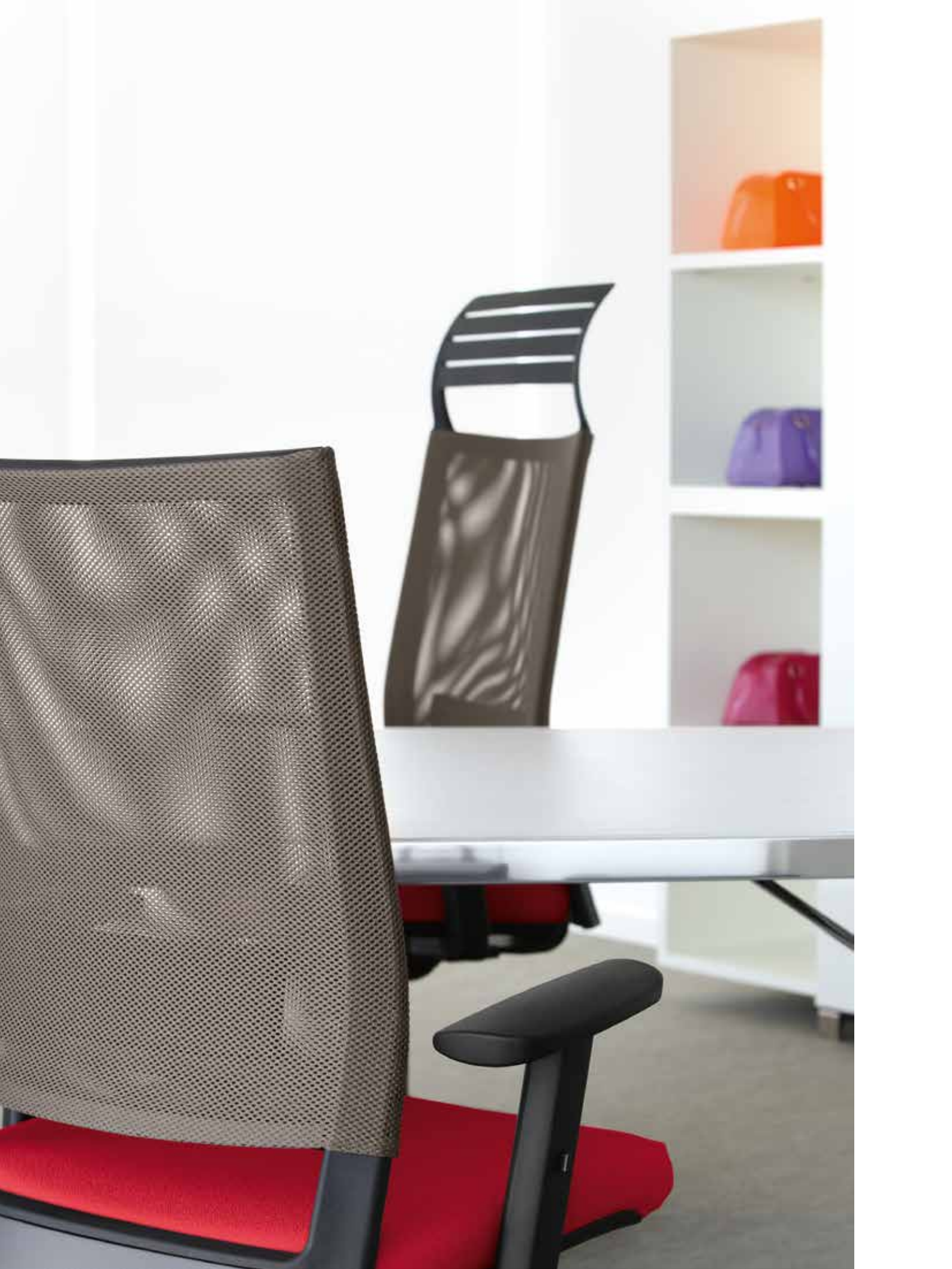



QXPKD - QXPID < QXPKD ^

OPERATIVE TASK

EXPO LIGHT QX/LX E IQ/IX ADVANCED SWIVEL CHAIR



IXTZX



IXSID





IQP5D





OPERATIVE TASK

## EXPO LIGHT QX/LX E IQ/IX ADVANCED SWIVEL CHAIR

IXTZX



IXSID



IQP5D



SCHIENALE IMBOTTITO UPHOLSTERED BACKREST

LYTYX



LXSZX



LXSIL



LXS5L



SCHIENALE IN RETE, BASE ALLUMINIO MESH BACKREST, ALUMINIUM BASE

## MODELLI DISPONIBILI AVAILABLE MODELS

### IX/IQ

Schienale imbottito / Upholstered backrest / Dossier rembouré / Respaldo tapizado

### QX/LX/LY

Schienale in rete / Mesh backrest / Dossier en maille / Respaldo de malla

## MISURE E VARIANTI SIZES AND VARIANTS

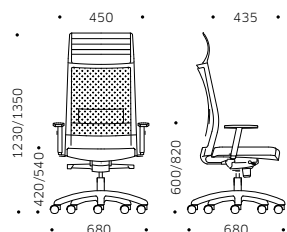

LXSZX / IXTZX

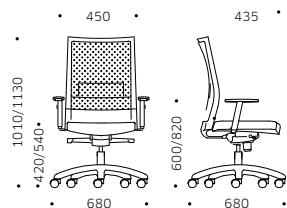

LXSIL

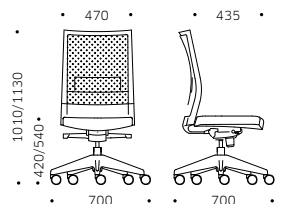

LXS5L

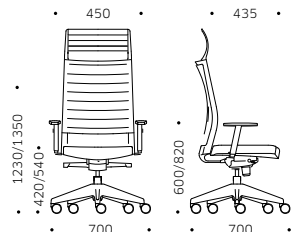

IXTZX

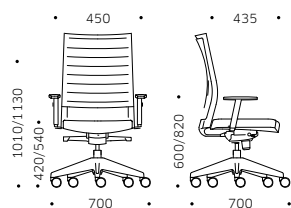

IXSID

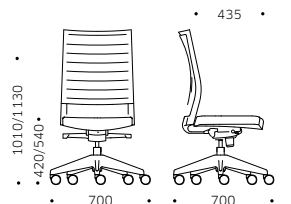

IQP5D

## DOTAZIONI MECCANICHE MECHANICAL FEATURES

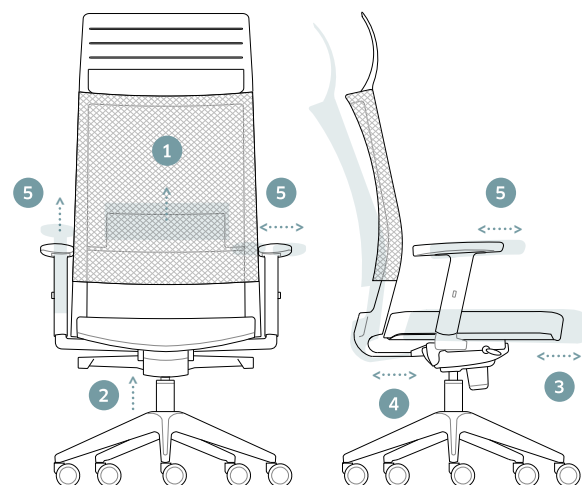

## FINITURE FINISHES

### PARTI METALLICHE METAL PARTS

Verniciato nero / Black painted / Verni couleur noir / Acabado en negro

### PARTI IN PLASTICA PLASTIC PARTS

Nero / Black / Noir / Negro

### PARTI IN ALLUMINIO ALUMINIUM PARTS

Lucido, verniciato nero o argento (RAL 9006) / Polished, black or silver (RAL 9006) painted / Poli, verni couleur noir, ou argent (RAL 9006) / Pulido, acabado en negro o plateado (RAL 9006)

## ACCESSORI ACCESSORIES

### POGGIATESTA HEADREST

Imbottito o polipropilene / Upholstered or polypropylene / Rembouré ou polypropylène / Tapizado o polipropileno

### BRACCIOLO ARMREST

Forma a "T" / "T" shaped / En forme de "T" / En forma de "T"

### BASE GIREVOLE SWIVEL BASE

Alluminio a 5 razze / Aluminium 5 stars / Aluminium 5 branches / Aluminio de 5 radios  
Poliamide a 5 razze / Polyamide 5 stars / Polyamide 5 branches / Poliamida de 5 radios

## RIVESTIMENTI COVERINGS



rete  
netting  
réseau  
red

RE - RS



pelle  
leather  
cuir  
cuero

EP - FP



tessuto  
fabric  
tissu  
tela

AG - AR - AL - BR

BB - BL - CR - CT

CE - DB - ET

## CERTIFICAZIONI CERTIFICATIONS

D.L. 81/08 EN 1335 Test by CATAS

Omologazione Ministeriale in Classe 11M - Solo per serie con schienale rivestito (modelli IX e IQ)

- 1 Appoggio lombare regolabile in altezza / Height adjustable lumbar support / Réglable en hauteur, support lombaire / Soporte lumbar regulable en altura
- 2 Sedile regolabile in altezza / Height adjustable seat / Siège réglable en hauteur / Asiento regulable en altura
- 3 Sedile regolabile in profondità / Depth-adjustable seat / Siège réglable en profondeur / Asiento regulable en profundidad
- 4 Meccanismo di inclinazione sincronizzata / Seat and back synchronized inclination mechanism / Mécanisme d'inclinaison synchronisé du siège et du dossier / Mecanismo de inclinación de asiento y respaldo sincronizada  
Dispositivo regolazione di tensione / Device for tension adjustment / Système d'ajustement de la tension / Dispositivo de ajuste de tensión de oscilación  
Sistema di sicurezza antiritorno / Anti-return safety system / Système de sécurité anti-retour / Mecanismo de seguridad anti-retorno
- 5 Bracciolo regolabile in altezza, larghezza, profondità, con appoggio orientabile / Height, width, depth-adjustable armrest, pivoting arm-cap / Accoudoir ajustable en hauteur, largeur, profondeur avec support pivotant / Reposabrazos ajustable en altura, anchura, profundidad con apoyobrazo orientable



# EXPO LIGHT GUEST CHAIR

Design by Vaghi R&D

Collezione elegante e raffinata, dalle linee leggere e fluide, che offre una serie di sedute dal design contemporaneo, ideale per ospiti e sale riunioni.

**EN** Elegant, stylish range with light, fluid lines, offering a highly contemporary selection of chairs for visitors and meetings.

**FR** Chic et élégante, arborant une ligne légère et épurée, qui propose une série très contemporaine de sièges pour visiteurs et réunion.

**ES** Distinguida y elegante, haciendo gala de una línea ligera y depurada, que propone una serie de sillas muy actual para visitas y salas de reunión.

OPERATIVE TASK  
EXPO LIGHT GUEST CHAIR



LX2VL ▲ LX2VN - LXOEX - QXOND >





OPERATIVE TASK

# EXPO LIGHT GUEST CHAIR

LXOEX



QXOND



BASE GIREVOLE SWIVEL BASE

LX2VL



LX2VN



BASE FISSA FIXED BASE

## MISURE E VARIANTI SIZES AND VARIANTS

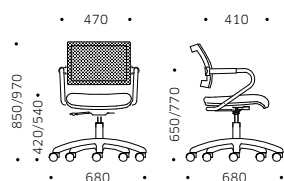

QXOND

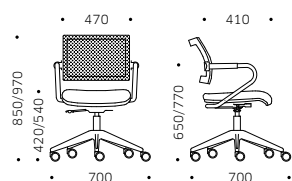

LXOEX

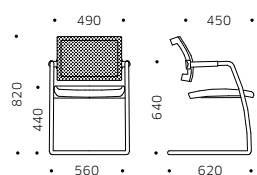

LX2VN / LX2VL

## CERTIFICAZIONI CERTIFICATIONS

EN 16139 EN 1022 EN 1728 Test by CATAS

## FINITURE FINISHES

### PARTI METALLICHE METAL PARTS

Cromato, verniciato nero o argento (RAL 9006) / Chromed, black or silver (RAL 9006) painted / Chrome, verni couleur noir, ou argent (RAL 9006) / Cromo, acabado en negro o plateado (RAL 9006)

### PARTI IN PLASTICA PLASTIC PARTS

Nero / Black / Noir / Negro

### PARTI IN ALLUMINIO ALUMINIUM PARTS

Lucido, verniciato nero o argento (RAL 9006) / Polished, black or silver (RAL 9006) painted / Poli, verni couleur noir, ou argent (RAL 9006) / Pulido, acabado en negro o plateado (RAL 9006)

## ACCESSORI ACCESSORIES

### BRACCIOLO ARMREST

Acciaio con appoggio in polipropilene / Steel with polypropylene pad / Acier avec soutien en polypropylène / Acero con apoyo en polipropileno

### BASE GIREVOLE SWIVEL BASE

Alluminio a 5 razze / Aluminium 5 stars / Aluminium 5 branches / Aluminio de 5 radios

Poliamide a 5 razze / Polyamide 5 stars / Polyamide 5 branches / Poliamida de 5 radios

### BASE FISSA FIXED BASE

A cantilever con braccioli, appoggio in polipropilene / Cantilever with armrests, polypropylene pad / Piètement luge avec accoudoirs, soutien en polypropylène / Trineo con apoyabrazos, apoyo en polipropileno

## RIVESTIMENTI COVERINGS



rete  
netting  
réseau  
red

RE - RS



tessuto  
fabric  
tissu  
tela

AG - AR - AL - BR - BB - BL - CR - CT - CE - DB - ET



pelle  
leather  
cuir  
cuero

EP - FP

## DOTAZIONI MECCANICHE TECHNICAL FEATURES

Sedile regolabile in altezza

EN Height adjustable seat

FR Siège réglable en hauteur

ES Asiento regulable en altura



# BURSA RETE EVOLUTION WHITE ADVANCED SWIVEL CHAIR

Design by Vaghi R&D

Lo schienale  
è stato disegnato  
per distribuire  
uniformemente  
il peso  
dell'utilizzatore  
ed è dotato  
di un appoggio  
lombare  
di facile utilizzo.

- EN** The backrest has been designed to distribute in an uniform way the user's weight and it is equipped with a friendly use lumbar support.
- FR** Le dossier a été conçu pour distribuer homogènement le poids de l'usager et est équipé d'un soutien lombaire qui s'active facilement.
- ES** El respaldo ha sido diseñado para distribuir de forma homogénea el peso del usuario y incorpora un refuerzo lumbar que se activa fácilmente.



Configura la tua seduta /  
Set up your chair

OPERATIVE TASK

## BURSA RETE EVOLUTION WHITE ADVANCED SWIVEL CHAIR



RB55B



IB5VB



RBSVB



IBS5B







OPERATIVE TASK

# BURSA RETE EVOLUTION WHITE ADVANCED SWIVEL CHAIR

RBSVB



RBS5B



SCHIENALE IN RETE MESH BACKREST

IBSVB



IBS5B



SCHIENALE IMBOTTITO UPHOLSTERED BACKREST

## MODELLI DISPONIBILI AVAILABLE MODELS

### RB

Struttura bianca e schienale in rete / white frame and mesh backrest /  
Structure blanche et dossier en maille / Estructura blanco y respaldo  
de malla

### IB

Struttura bianca e schienale rivestito e imbottito / white frame and  
upholstered backrest / Structure blanche et dossier rembouré /  
Estructura blanco y respaldo tapizado

## MISURE E VARIANTI SIZES AND VARIANTS

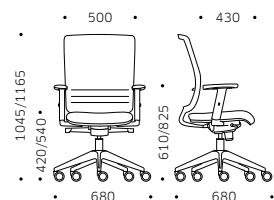

IB5VB

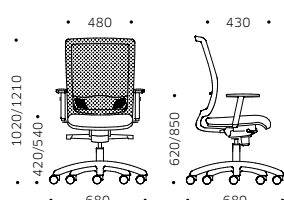

RB5VB

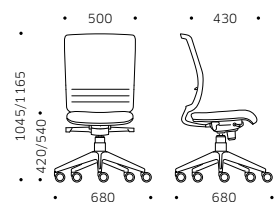

IB55B

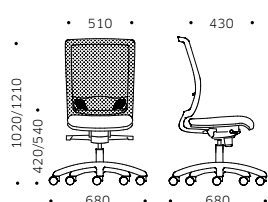

RB55B

## CERTIFICAZIONI CERTIFICATIONS

D.L. 81/08 EN 1335 Test by CATAS  
Omologazione Ministeriale in Classe 1IM

## FINITURE FINISHES

### PARTI METALLICHE METAL PARTS

Verniciato nero / Black painted / Verni couleur noir / Acabado  
en negro

### PARTI IN PLASTICA PLASTIC PARTS

Nero / Black / Noir / Negro  
Bianco / White / Blanc / Blanco

### PARTI IN ALLUMINIO ALUMINIUM PARTS

Verniciato bianco (RAL 9016) / White painted (RAL 9016) /  
Verni couleur blanc (RAL 9016) / Acabado en blanco (RAL 9016)

## ACCESSORI ACCESSORIES

### BRACCIOLO ARMREST

Forma a "T" / "T" shaped / En forme de "T" / En forma de "T"

### BASE GIREVOLE SWIVEL BASE

Alluminio a 5 razze / Aluminium 5 stars / Aluminium 5 branches /  
Aluminio de 5 radios  
Poliammide a 5 razze / Polyamide 5 stars / Polyamide 5 branches /  
Poliamida de 5 radios

## RIVESTIMENTI COVERINGS



rete  
netting  
réseau  
red



tessuto  
fabric  
tissu  
tela

RE

AG - AR - AL - BR - BB - BL - CR  
CT - CE - DB

## DOTAZIONI MECCANICHE MECHANICAL FEATURES

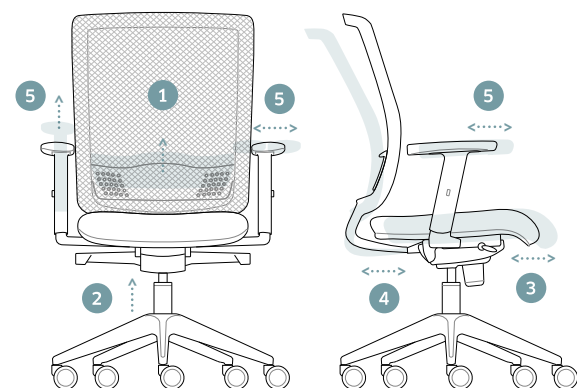

- 1 Appoggio lombare regolabile in altezza / Height adjustable lumbar support / Support lombaire ajustable en hauteur / Soporte lumbar regulable en altura
- 2 Sedile regolabile in altezza / Height adjustable seat / Siège réglable en hauteur / Asiento regulable en altura
- 3 Sedile regolabile in profondità / Depth-adjustable seat / Siège réglable en profondeur / Asiento regulable en profundidad
- 4 Meccanismo di inclinazione sincronizzata / Seat and back synchronized inclination mechanism / Mécanisme d'inclinaison synchronisé du siège et du dossier / Mecanismo de inclinación de asiento y respaldo sincronizada  
Dispositivo regolazione di tensione / Device for tension adjustment / Système d'ajustement de la tension / Dispositivo de ajuste de tensión de oscilación  
Sistema di sicurezza antiritorno / Anti-return safety system / Système de sécurité anti-retour / Mecanismo de seguridad anti-retorno
- 5 Bracciolo regolabile in altezza, larghezza, profondità, con appoggio orientabile / Height, width, depth-adjustable armrest, pivoting arm-cap / Accoudoir ajustable en hauteur, largeur, profondeur avec support pivotant / Reposabrazos ajustable en altura, anchura, profundidad con apoyobrazo orientable



# BURSA RETE EVOLUTION BLACK ADVANCED SWIVEL CHAIR

Design by Vaghi R&D

Lo schienale  
è stato disegnato  
per distribuire  
uniformemente  
il peso  
dell'utilizzatore  
ed è dotato  
di un appoggio  
lombare  
di facile utilizzo.

- EN** The backrest has been designed to distribute in an uniform way the user's weight and it is equipped with a friendly use lumbar support.
- FR** Le dossier a été conçu pour distribuer homogènement le poids de l'usager et est équipé d'un soutien lombaire qui s'active facilement.
- ES** El respaldo ha sido diseñado para distribuir de forma homogénea el peso del usuario y incorpora un refuerzo lumbar que se activa fácilmente.



Configura la tua seduta /  
Set up your chair

OPERATIVE TASK

BURSA RETE EVOLUTION BLACK ADVANCED SWIVEL CHAIR



IISKX



RESIX



REP KD



REP 6 D







OPERATIVE TASK

## BURSA RETE EVOLUTION BLACK ADVANCED SWIVEL CHAIR

IISKX



SCHIENALE E POGGIATESTA IMBOTTITO UPHOLSTERED BACKREST AND HEADREST

REPKD



RITZX



SCHIENALE IN RETE CON POGGIATESTA MESH BACKREST WITH HEADREST

RESIX



REP6D



REP5D



SCHIENALE IN RETE MESH BACKREST

## MODELLI DISPONIBILI AVAILABLE MODELS

### RE/RI

Struttura nera e schienale in rete / black frame and mesh backrest / Structure noire et dossier en maille / Estructura negro y respaldo de malla

### IE/II

Struttura nera e schienale imbottito / black frame and upholstered backrest / Structure noire et dossier rembouré / Estructura negro y respaldo tapizado

## MISURE E VARIANTI SIZES AND VARIANTS

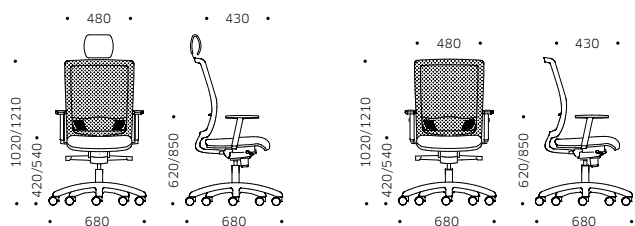

### REP KD

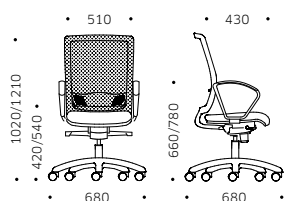

### RBS VB

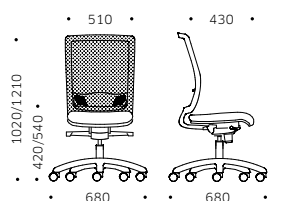

### REP 6 D

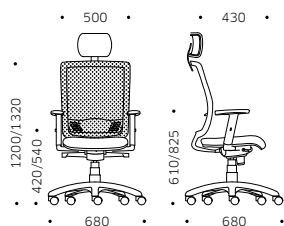

### RBS 5 B

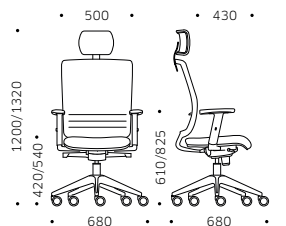

### RIT ZX

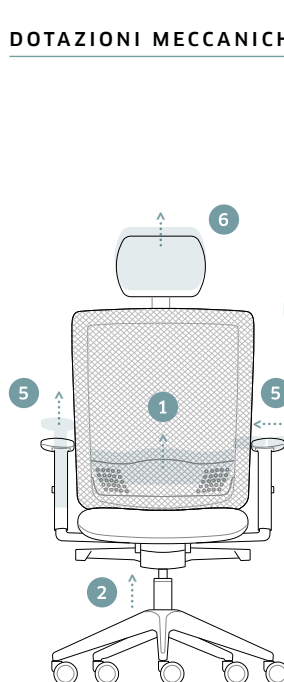

### IISK X



## DOTAZIONI MECCANICHE MECHANICAL FEATURES

## FINITURE FINISHES

### PARTI METALLICHE METAL PARTS

Verniciato nero / Black painted / Verni couleur noir / Acabado en negro

### PARTI IN PLASTICA PLASTIC PARTS

Nero / Black / Noir / Negro

### PARTI IN ALLUMINIO ALUMINIUM PARTS

Lucido, verniciato nero / Polished, black painted / Poli, verni couleur noir / Pulido, acabado en negro

## ACCESSORI ACCESSORIES

### POGGIATESTA HEADREST

Imbottito o poliuretano / Upholstered or polyurethane / Rembouré ou polyuréthane / Tapizado o poliuretano

### BRACCIOLLO ARMREST

Ad anello in polipropilene / Ring-shaped polypropylene / Accoudoirs en forme d'anneau en polypropylène / En forma de anillo en polipropileno

Forma a "T" / "T" shaped / En forme de "T" / En forma de "T"

### BASE GIREVOLE SWIVEL BASE

Alluminio a 5 razze / Aluminium 5 stars / Aluminium 5 branches / Aluminio de 5 radios

Poliammide a 5 razze / Polyamide 5 stars / Polyamide 5 branches / Poliamida de 5 radios

## RIVESTIMENTI COATING



rete  
netting  
réseau  
red



tessuto  
fabric  
tissu  
tela

RE

AG - AR - AL - BR - BB - BL - CR  
CT - CE - DB

## CERTIFICAZIONI CERTIFICATIONS

D.L. 81/08 EN 1335 Test by CATAS

Omologazione Ministeriale in Classe 11M

- 1 Appoggio lombare regolabile in altezza / Height adjustable lumbar support / Support lombaire ajustable en hauteur / Soporte lumbar regulable en altura
- 2 Sedile regolabile in altezza / Height adjustable seat / Siège réglable en hauteur / Asiento regulable en altura
- 3 Sedile regolabile in profondità / Depth-adjustable seat / Siège réglable en profondeur / Asiento regulable en profundidad
- 4 Meccanismo di inclinazione sincronizzata / Seat and back synchronized inclination mechanism / Mécanisme d'inclinaison synchronisé du siège et du dossier / Mecanismo de inclinación de asiento y respaldo sincronizada  
Dispositivo regolazione di tensione / Device for tension adjustment / Système d'ajustement de la tension / Dispositivo de ajuste de tensión de oscilación  
Sistema di sicurezza antiritorno / Anti-return safety system / Système de sécurité anti-retour / Mecanismo de seguridad anti-retorno
- 5 Bracciolo regolabile in altezza, larghezza, profondità, con appoggio orientabile / Height, width, depth-adjustable armrest, pivoting arm-cap / Accoudoir ajustable en hauteur, largeur, profondeur avec support pivotant / Reposabrazos ajustable en altura, anchura, profundidad con apoyobrazo orientable
- 6 Poggiatesta regolabile in altezza e inclinazione / Titing headrest, height adjustable headrest / Appuie-tête inclinable et réglable en hauteur / Apoyacabezas regulable en inclinación y altura



LAZIO  
MADE IN ITALY

311

# BURSA RETE STANDARD SWIVEL CHAIR

Design by Vaghi R&D

Si caratterizza  
per la forma  
sagomata dello  
schienale in rete,  
progettato per  
offrire il massimo  
comfort di seduta

**EN** It features a very attractive and distinctive curved mesh backrest, designed to provide maximum comfort.

**FR** Se distingue notamment par son ravissant dossier incurvé en maille, étudié pour offrir un confort optimal.

**ES** Se distingue sobre todo por su precioso respaldo curvado de malla, estudiado para ofrecer un confort óptimo.

OPERATIVE TASK  
BURSA RETE STANDARD SWIVEL CHAIR



RGS4D ^ RISID >



OPERATIVE TASK  
BURSA RETE STANDARD SWIVEL CHAIR

RISID



PLASTICA NERA BLACK PLASTIC

RGS4D



RGS3D



PLASTICA GRIGIA GREY PLASTIC



## MISURE E VARIANTI SIZES AND VARIANTS

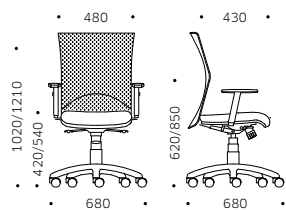

RISID

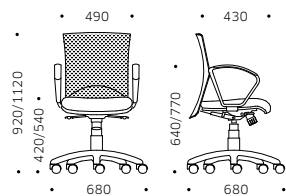

RGS4D

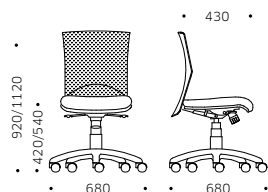

RGS3D

## CERTIFICAZIONI CERTIFICATIONS

D.L. 81/08 EN 1335 Test by CATAS

## FINITURE FINISHES

### PARTI METALLICHE METAL PARTS

Verniciato nero / Black painted / Verni couleur noir / Acabado en negro

### PARTI IN PLASTICA PLASTIC PARTS

Nero o grigio (RAL 7040) / Black or grey (RAL 7040) / Noir ou gris (RAL 7040) / Negro o gris (RAL 7040)

### PARTI IN ALLUMINIO ALUMINIUM PARTS

Lucido, verniciato nero o argento (RAL 9006) / Polished, black or silver (RAL 9006) painted / Poli, verni couleur noir, ou argent (RAL 9006) / Pulido, acabado en negro o plateado (RAL 9006)

## ACCESSORI ACCESSORIES

### BRACCIOLO ARMREST

Ad anello o di forma a "T" in polipropilene / Ring or "T"-shaped polypropylene / Accoudoirs en forme d'anneau ou de "T" en polypropylène / En forma de anillo o de "T" en polipropileno

### BASE GIREVOLE SWIVEL BASE

Alluminio a 5 razze / Aluminium 5 stars / Aluminium 5 branches / Aluminio de 5 radios

Acciaio a 5 razze / Steel 5 stars / Acier 5 branches / Acero de 5 radios  
Poliamide a 5 razze / Polyamide 5 stars / Polyamide 5 branches / Poliamida de 5 radios

## RIVESTIMENTI COVERINGS



rete  
netting  
réseau  
red

### RE



tessuto  
fabric  
tissu  
tela

AG - AR - AL - BR - BB - BL - CR - CT - CE - DB - ET

## DOTAZIONI MECCANICHE TECHNICAL FEATURES

Schienale regolabile in altezza / Sedile regolabile in altezza / Meccanismo di inclinazione sincronizzata / Dispositivo regolazione di tensione / Sistema di sicurezza antiritorno / Bracciolo regolabile in altezza

- EN Adjustable backrest / Height adjustable seat / Seat and back synchronized inclination mechanism / Device for tension adjustment / Anti-return safety system / Height-adjustable armrest
- FR Dossier ajustable en hauteur / Siège réglable en hauteur / Mécanisme d'inclinaison synchronisé du siège et du dossier / Système d'ajustement de la tension / Système de sécurité anti-retour / Accoudoir ajustable en hauteur
- ES Respaldo regulable en altura / Asiento regulable en altura / Mecanismo de inclinación de asiento y respaldo sincronizada / Dispositivo de ajuste de tensión de oscilación / Mecanismo de seguridad anti-retorno / Reposabrazos ajustable en altura



# BURSA RETE GUEST CHAIR

Design by Vaghi R&D

Seduta ospiti  
con schienale  
in rete portante  
ad elevata  
resistenza  
e sedile imbottito,  
progettata  
per garantire  
il massimo comfort  
di seduta.

**EN** Guest chair with top quality mesh backrest and upholstered seat, this chair has been designed to ensure a comfortable sitting position.

**FR** Siège visiteur avec dossier en maille portante haute qualité et assise tapissée, a été étudié pour offrir un confort intégral.

**ES** Silla de visita con respaldo en malla auto portante de alta calidad y con asiento tapizado, ha sido diseñado para ofrecer el máximo confort.





RN03D < RG2CA ^

OPERATIVE TASK  
BURSA RETE GUEST CHAIR

RN03D



PLASTICA NERA BLACK PLASTIC

RN1CN



RG04D



PLASTICA GRIGIA GREY PLASTIC

RG2CA



## MISURE E VARIANTI SIZES AND VARIANTS

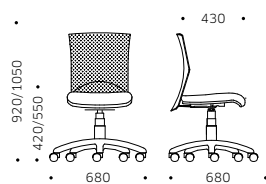

RNO3D

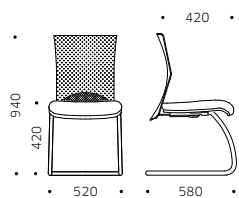

RN1CN

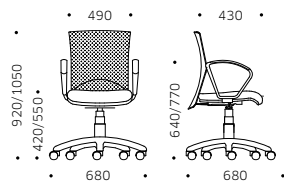

RGO4D

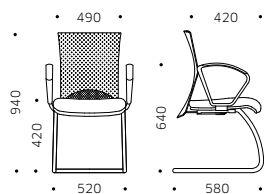

RG2CA

## CERTIFICAZIONI CERTIFICATIONS

EN 16139 EN 1022 EN 1728 Test by CATAS

## FINITURE FINISHES

### PARTI METALLICHE METAL PARTS

Verniciato nero o argento (RAL 9006) / Black or silver (RAL 9006) painted / Verni couleur noir, ou argent (RAL 9006) / Acabado en negro o plateado (RAL 9006)

### PARTI IN PLASTICA PLASTIC PARTS

Nero o grigio (RAL 7040) / Black or grey (RAL 7040) / Noir ou gris (RAL 7040) / Negro o gris (RAL 7040)

### PARTI IN ALLUMINIO ALUMINIUM PARTS

Lucido, verniciato nero o argento (RAL 9006) / Polished, black or silver (RAL 9006) painted / Poli, verni couleur noir, ou argent (RAL 9006) / Pulido, acabado en negro o plateado (RAL 9006)

## ACCESSORI ACCESSORIES

### BRACCIOLO ARMREST

Ad anello in polipropilene / Ring-shaped polypropylene / Accoudoirs en forme d'anneau en polypropylène / En forma de anillo en polipropileno

### BASE GIREVOLE SWIVEL BASE

Alluminio a 5 razze / Aluminium 5 stars / Aluminium 5 branches / Aluminio de 5 radios  
 Poliammide a 5 razze / Polyamide 5 stars / Polyamide 5 branches / Poliamida de 5 radios

### BASE FISSA FIXED BASE

Acciaio a cantilever / Steel cantilever shaped / Piètement luge en acier / Tipo trineo de acero

## RIVESTIMENTI COVERINGS



rete  
netting  
réseau  
red

RE



tessuto  
fabric  
tissu  
tela

AG - AR - AL - BR - BB - BL - CR - CT - CE - DB - ET

## DOTAZIONI MECCANICHE TECHNICAL FEATURES

Sedile regolabile in altezza

- EN Height adjustable seat
- FR Siège réglable en hauteur
- ES Asiento regulable en altura





# AVILA BURSA STANDARD SWIVEL CHAIR

Design by Vaghi R&D

Schienale  
e sedile dalle  
forme generose  
ed avvolgenti,  
questo prodotto  
offre tutti i  
vantaggi della  
classica seduta  
da lavoro.

**EN** Wide back and seat  
to enfold the user,  
this product offers  
all the advantages  
of a standard office chair.

**FR** Assise et dossier  
volumineux et enveloppants,  
ce produit réunit tous  
les atouts d'un siège  
de bureautique standard.

**ES** Asiento y respaldo  
voluminosos y envolventes,  
este product combina todas  
las ventajas de una sillade  
oficina estándar.

OPERATIVE TASK  
AVILA BURSA STANDARD SWIVEL CHAIR



BISID ^ GNS8D >







OPERATIVE TASK

## AVILA BURSA STANDARD SWIVEL CHAIR



SCHIENALE IMBOTTITO CON POGGIATESTA UPHOLSTERED BACKREST WITH HEADREST



SCHIENALE IMBOTTITO UPHOLSTERED BACKREST

## MISURE E VARIANTI SIZES AND VARIANTS

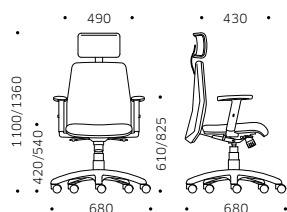

BRSKD

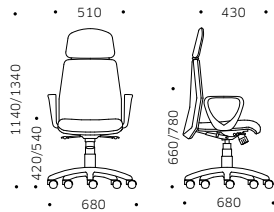

GNS8D

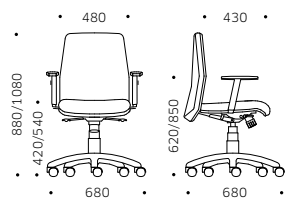

BISID

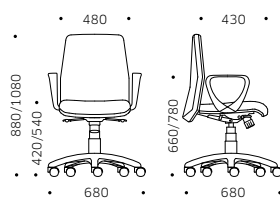

GNS6D

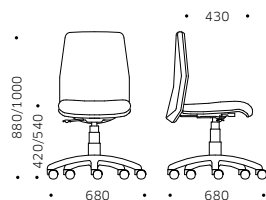

BNS5D

## CERTIFICAZIONI CERTIFICATIONS

D.L. 81/08 EN 1335 Test by CATAS  
Omologazione Ministeriale in Classe 1M

## FINITURE FINISHES

### PARTI METALLICHE METAL PARTS

Verniciato nero / Black painted / Verni couleur noir / Acabado en negro

### PARTI IN PLASTICA PLASTIC PARTS

Nero / Black / Noir / Negro

### PARTI IN ALLUMINIO ALUMINIUM PARTS

Lucido, verniciato nero o argento (RAL 9006) / Polished, black or silver (RAL 9006) painted / Poli, verni couleur noir, ou argent (RAL 9006) / Pulido, acabado en negro o plateado (RAL 9006)

## ACCESSORI ACCESSORIES

### POGGIATESTA HEADREST

Imbottito / Upholstered / Rembouré / Tapizado

### BRACCIOLO ARMREST

Ad anello o di forma a "T" in polipropilene / Ring or "T"-shaped polypropylene / Accoudoirs en forme d'anneau ou de "T" en polypropylène / En forma de anillo o de "T" en polipropileno

### BASE GIREVOLE SWIVEL BASE

Alluminio a 5 razze / Aluminium 5 stars / Aluminium 5 branches / Aluminio de 5 radios  
Poliamide a 5 razze / Polyamide 5 stars / Polyamide 5 branches / Poliamida de 5 radios

## RIVESTIMENTI COVERINGS



tessuto  
fabric  
tissu  
tela

AG - AR - AL - BR - BB - BL - CR - CT - CE - DB - ET

## DOTAZIONI MECCANICHE TECHNICAL FEATURES

Schienale regolabile in altezza / Sedile regolabile in altezza /  
Meccanismo di inclinazione sincronizzata / Dispositivo regolazione di tensione / Sistema di sicurezza antiritorno / Bracciolo regolabile in altezza / Poggiatesta regolabile in altezza e inclinazione

**EN** Adjustable backrest / Height adjustable seat / Seat and back synchronized inclination mechanism / Device for tension adjustment / Anti-return safety system / Height-adjustable armrest / Tilting headrest, height adjustable headrest

**FR** Dossier ajustable en hauteur / Siège réglable en hauteur / Mécanisme d'inclinaison synchronisé du siège et du dossier / Système d'ajustement de la tension / Système de sécurité anti-retour / Accoudoir ajustable en hauteur / Appuie-tête inclinable et réglable en hauteur

**ES** Respaldo regulable en altura / Asiento regulable en altura / Mecanismo de inclinación de asiento y respaldo sincronizada / Dispositivo de ajuste de tensión de oscilación / Mecanismo de seguridad anti-retorno / Reposabrazos ajustable en altura / Apoyacabezas regulable en inclinación y altura





# MOREA COMFORT ADVANCED SWIVEL CHAIR

Design by Vaghi R&D

Le proporzioni  
sottilmente generose  
e ben arrotondate  
sono il risultato  
di un design  
caratterizzato  
e tuttavia universale  
e moderno. Scocca  
nera o bianca.

**EN** Their subtly generous,  
well-rounded proportions  
are distinctive,  
universal and modern.  
Black or white shell.

**FR** Ils s'imposent par leurs  
volumes subtilement travaillés  
autour de formes généreuses  
et arrondies mais résolument  
modernes et universelles.  
Coques noires ou blanches.

**ES** Destacan por sus volúmenes  
generosos, sutilmente  
trabajados, inspirando  
modernidad y universalidad.  
Acabado negro o blanco.







CMPID - CMPKD < CBSDX ^





OPERATIVE TASK  
MOREA COMFORT ADVANCED SWIVEL CHAIR

CMPKD



CMPID



CMP6D



CMP5D



BASE PLASTICA PLASTIC BASE

CBSDX



CBSYX



CBSFB



CBSVB



BASE ALLUMINIO ALUMINIUM BASE

## MISURE E VARIANTI SIZES AND VARIANTS

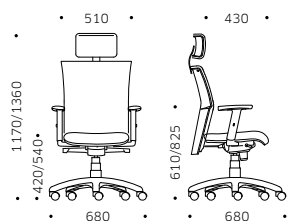

**CMPKD**

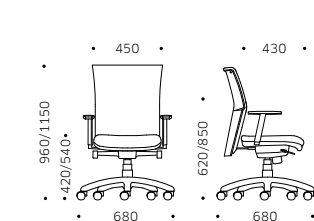

**CMPID**

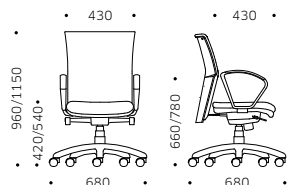

**CMP6D**

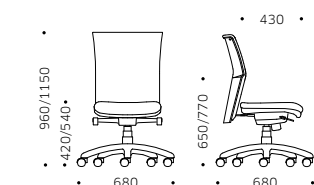

**CMP5D**

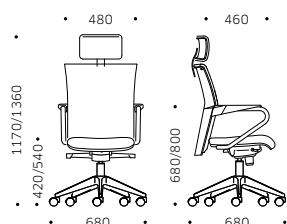

**CBSDX**

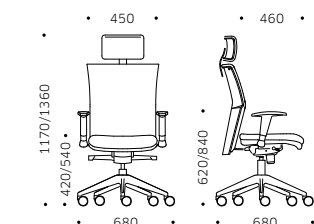

**CBSYX**

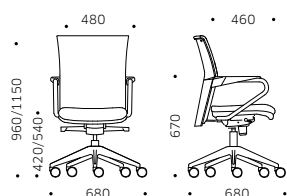

**CBSFB**

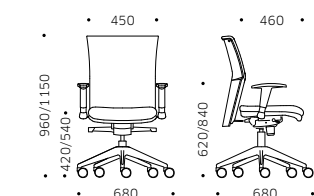

**CBSVB**

## CERTIFICAZIONI CERTIFICATIONS

D.L. 81/08 EN 1335 Test by CATAS

Omologazione Ministeriale in Classe 11M

## DOTAZIONI MECCANICHE MECHANICAL FEATURES

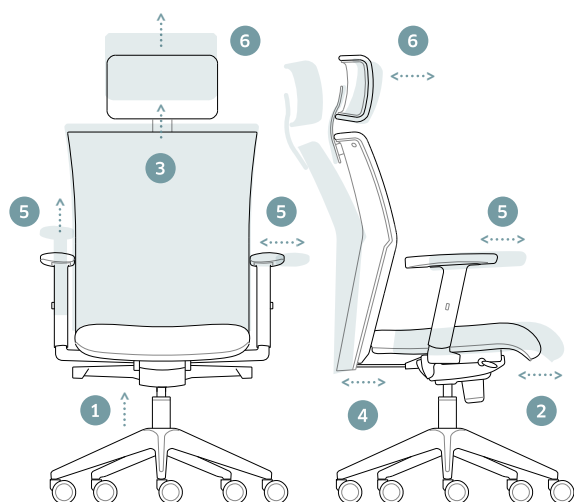

- 1 Sedile regolabile in altezza / Height adjustable seat / Siège réglable en hauteur / Asiento regulable en altura
- 2 Sedile regolabile in profondità / Depth-adjustable seat / Siège réglable en profondeur / Asiento regulable en profundidad
- 3 Schienale regolabile in altezza / Height adjustable backrest / Dossier ajustable en hauteur / respaldo regulable en altura
- 4 Meccanismo di inclinazione sincronizzata / Seat and back synchronized inclination mechanism / Mécanisme d'inclinaison synchronisé du siège et du dossier / Mecanismo de inclinación de asiento y respaldo sincronizada  
Dispositivo regolazione di tensione / Device for tension adjustment / Système d'ajustement de la tension / Dispositivo de ajuste de tensión de oscilación  
Sistema di sicurezza antiritorno / Anti-return safety system / Système de sécurité anti-retour / Mecanismo de seguridad anti-retorno
- 5 Bracciolo regolabile in altezza, larghezza, profondità, con appoggio orientabile / Height, width, depth-adjustable armrest, pivoting arm-cap / Accoudoir ajustable en hauteur, largeur, profondeur avec support pivotant / Reposabrazos ajustable en altura, anchura, profundidad con apoyobrazo orientable
- 6 Poggiatesta regolabile in altezza e inclinazione / Titing headrest, height adjustable headrest / Appuie-tête inclinable et réglable en hauteur / Apoyacabezas regulable en inclinación y altura

## MODELLI DISPONIBILI AVAILABLE MODELS

### CM

Plastica nera / Black plastic / Plastique noir / Plástico negro

### CB

Plastica bianca / White plastic / Plastique blanc / Plástico blanco

## FINITURE FINISHES

### PARTI METALLICHE METAL PARTS

Verniciato nero o bianco (RAL 9016) / Black or white painted (RAL 9016) / Verni couleur noir ou blanc (RAL 9016) / Acabado en negro o blanco (RAL 9016)

### PARTI IN PLASTICA PLASTIC PARTS

Nero o bianco (RAL 9003) / Black or white (RAL 9003) / Noir ou blanc (RAL 9003) / Negro o blanco (RAL 9003)

### PARTI IN ALLUMINIO ALUMINIUM PARTS

Lucido, verniciato nero, argento (RAL 9006) o bianco (RAL 9016) / Polished, black, silver (RAL 9006) or white (RAL 9016) painted / Poli, verni couleur noir, argent (RAL 9006) ou blanc (RAL 9016) / Pulido, acabado en negro, plateado (RAL 9006) o blanco (RAL 9016)

## ACCESSORI ACCESSORIES

### POGGIATESTA HEADREST

Imbottito / Upholstered / Rembouré / Tapizado

### BRACCIOLA ARMREST

Ad anello in polipropilene / Ring-shaped polypropylene / Accoudoirs en forme d'anneau en polypropylène / En forma de anillo en polipropileno  
Forma a "T" / "T" shaped / En forme de "T" / En forma de "T"  
Acciaio con appoggio in polipropilene / Steel with polypropylene pad / Acier avec soutien en polypropylène / Acero con apoyo en polipropileno

### BASE GIREVOLE SWIVEL BASE

Alluminio a 5 razze / Aluminium 5 stars / Aluminium 5 branches / Aluminio de 5 radios  
Poliamide a 5 razze / Polyamide 5 stars / Polyamide 5 branches / Poliamida de 5 radios

## RIVESTIMENTI COVERINGS



pelle  
leather  
cuir  
cuero

EP - FP



tessuto  
fabric  
tissu  
tela

AG - AR - AL - BR - BB - BL - CR

CT - CE - DB - ET





# MOREA COMFORT GUEST CHAIR

Design by Vaghi R&D

Questo prodotto è la soluzione ideale come seduta ospiti ed è adatto anche per sale riunioni e conferenze.

- EN** This product is the ideal visitor chair and is equally suited to boardroom, meeting and conference spaces.
- FR** Ce produit est le siège d'accompagnement idéal pour les visiteurs et convient également aux salles de réunion et de conférence.
- ES** Esta gama es la silla ideal para acompañantes y se adapta por igual a salas de juntas, reuniones y conferencias.

OPERATIVE TASK

# MOREA COMFORT GUEST CHAIR



CBOEX ^ CMOEX >







CB2VB - CM2VN - CB2VL

OPERATIVE TASK

# MOREA COMFORT GUEST CHAIR

CBOEB



CBOEX



CMONL



BASE GIREVOLE SWIVEL BASE

CB2VB



CB2VL



CM2VN



BASE FISSA FIXED BASE

## MODELLI DISPONIBILI AVAILABLE MODELS

### CM

Plastica nera  
Black plastic  
Plastique noir  
Plástico negro

### CB

Plastica bianca  
White plastic  
Plastique blanc  
Plástico blanco

## MISURE E VARIANTI SIZES AND VARIANTS

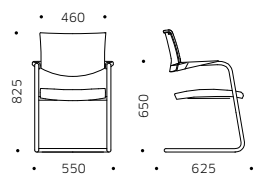

CB2VB / CM2VN / CB2VL

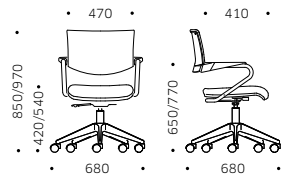

CBOEX / CBOEB / CMONL

## CERTIFICAZIONI CERTIFICATIONS

EN 16139 EN 1022 EN 1728 Test by CATAS  
Omologazione Ministeriale in Classe 1IM

## FINITURE FINISHES

### PARTI METALLICHE METAL PARTS

Cromato, verniciato nero, bianco (RAL 9016) o argento (RAL 9006) /  
Chromed, black, white (RAL 9016) or silver (RAL 9006) painted /  
Chrome, verni couleur noir, blanc (RAL 9016) ou argent (RAL 9006) /  
Cromo, acabado en negro, blanco (RAL 9016) o plateado (RAL 9006)

### PARTI IN PLASTICA PLASTIC PARTS

Nero o bianco (RAL 9003) / Black or white (RAL 9003) / Noir ou blanc  
(RAL 9003) / Negro o blanco (RAL 9003)

### PARTI IN ALLUMINIO ALUMINIUM PARTS

Lucido, verniciato nero, argento (RAL 9006) o bianco (RAL 9016) /  
Polished, black, silver (RAL 9006) or white (RAL 9016) painted / Poli,  
verni couleur noir, argent (RAL 9006) ou blanc (RAL 9016) / Pulido,  
acabado en negro, plateado (RAL 9006) o blanco (RAL 9016)

## ACCESSORI ACCESSORIES

### BRACCILO ARMREST

Acciaio con appoggio in polipropilene / Steel with polypropylene pad /  
Acier avec soutien en polypropylène / Acero con apoyo en polipropileno

### BASE GIREVOLE SWIVEL BASE

Alluminio a 5 razze / Aluminium 5 stars / Aluminium 5 branches /  
Aluminio de 5 radios  
Poliamide a 5 razze / Polyamide 5 stars / Polyamide 5 branches /  
Poliamida de 5 radios

### BASE FISSA FIXED BASE

A cantilever con braccioli, appoggio in polipropilene / Cantilever with  
armrests, polypropylene pad / Piètement luge avec accoudoirs, soutien  
en polypropylène / Trineo con apoyabrazos, apoyo en polipropileno

## RIVESTIMENTI COVERINGS



AG - AR - AL - BR - BB - BL CR - CT - CE - DB - ET



EP - FP

## DOTAZIONI MECCANICHE TECHNICAL FEATURES

Sedile regolabile in altezza

EN Height adjustable seat  
FR Siège réglable en hauteur  
ES Asiento regulable en altura





# MALTA STANDARD SWIVEL CHAIR

Design by Vaghi R&D

Sedute di  
elevata qualità  
per l'attività  
quotidiana.  
Le sue varianti  
sono tanto  
numerose quanto  
le tipologie  
di utilizzatori.  
Scocca nera  
o grigia.

**EN** Top-quality solution  
for everyday activity.

Its models are as different  
as the persons using them.  
Black or grey shell.

**FR** Sièges de bureau hautement  
qualitative pour l'activité  
quotidienne. Disponible  
en de nombreuses variantes  
et finitions. Cadre noir ou gris.

**ES** Solución de primera calidad  
que para el trabajo diario.  
Los modelos son tan  
variados como los usuarios.  
Acabado negro o gris.

OPERATIVE TASK  
MALTA STANDARD SWIVEL CHAIR



MFS4D ^ MGS4D >



OPERATIVE TASK

## MALTA STANDARD SWIVEL CHAIR

MIPID



PLASTICA NERA, SCHIENALE MEDIO BLACK PLASTIC, MEDIUM BACK

MHPHD

MFS4D

MFP3D



PLASTICA NERA, SCHIENALE BASSO BLACK PLASTIC, LOW BACK

MGS4D

MGP3D



PLASTICA GRIGIA, SCHIENALE BASSO GREY PLASTIC, LOW BACK

## FINITURE FINISHES

### PARTI METALLICHE METAL PARTS

Verniciato nero / Black painted / Verni couleur noir / Acabado en negro

### PARTI IN PLASTICA PLASTIC PARTS

Nero o grigio (RAL 7040) / Black or grey (RAL 7040) / Noir ou gris (RAL 7040) / Negro o gris (RAL 7040)

### PARTI IN ALLUMINIO ALUMINIUM PARTS

Lucido, verniciato nero o argento (RAL 9006) / Polished, black or silver (RAL 9006) painted / Poli, verni couleur noir, ou argent (RAL 9006) / Pulido, acabado en negro o plateado (RAL 9006)

## ACCESSORI ACCESSORIES

### BRACCIOLLO ARMREST

Ad anello in polipropilene / Ring-shaped polypropylene / Accoudoirs en forme d'anneau en polypropylène / En forma de anillo en polipropileno

Ad anello in poliuretano / Ring-shaped polyurethane / Accoudoirs en forme d'anneau en polyuréthane / En forma de anillo en poliuretano  
Forma a "T" / "T" shaped / En forme de "T" / En forma de "T"

### BASE GIREVOLE SWIVEL BASE

Alluminio a 5 razze / Aluminium 5 stars / Aluminium 5 branches / Aluminio de 5 radios

Acciaio a 5 razze / Steel 5 stars / Acier 5 branches / Acero de 5 radios  
Poliammide a 5 razze / Polyamide 5 stars / Polyamide 5 branches / Poliamida de 5 radios

## RIVESTIMENTI COVERINGS



tessuto  
fabric  
tissu  
tela

AG - AR - AL - BR - BB - BL - CR - CT - CE - DB

## MISURE E VARIANTI SIZES AND VARIANTS

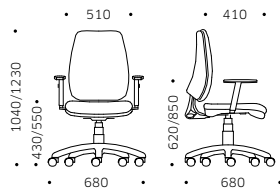

MIPID

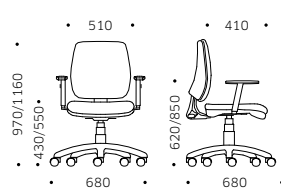

MHPHD

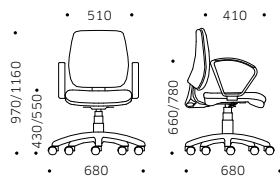

MGS4D / MFS4D

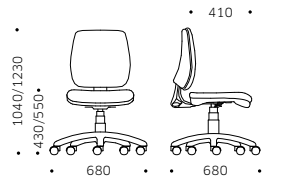

MFP3D / MGP3D

## CERTIFICAZIONI CERTIFICATIONS

D.L. 81/08 EN 1335 Test by CATAS  
Omologazione Ministeriale in Classe 11M

## DOTAZIONI MECCANICHE TECHNICAL FEATURES

Schienale regolabile in altezza / Sedile regolabile in altezza / Sedile regolabile in profondità / Meccanismo di inclinazione sincronizzata / Meccanismo di inclinazione schienale / Dispositivo regolazione di tensione / Sistema di sicurezza antiritorno / Bracciolo regolabile in altezza / Colonna con anello poggiatesta regolabile in altezza

- EN Adjustable backrest / Height adjustable seat / Depth-adjustable seat / seat and back synchronized inclination mechanism / Backrest inclination mechanism / Device for tension adjustment / Anti-return safety system / Height-adjustable armrest / Column with height-adjustable footrest ring
- FR Dossier ajustable en hauteur / Siège réglable en hauteur / Siège réglable en profondeur / Mécanisme d'inclinaison synchronisé du siège et du dossier / Mécanisme d'inclinaison du dossier / Système d'ajustement de la tension / Système de sécurité anti-retour / Accoudoir ajustable en hauteur / Colonne avec repose-pieds ajustable en hauteur
- ES Respaldo regulable en altura / Asiento regulable en altura / Asiento regulable en profundidad / Mecanismo de inclinación de respaldo / Dispositivo de ajuste de tensión de oscilación / Mecanismo de seguridad anti-retorno / Reposabrazos ajustable en altura / Columna con anillo reposapiés regulable en altura



# LYBRA STANDARD SWIVEL CHAIR

Design by Vaghi R&D

Soluzione ideale  
per chi cerca  
una seduta  
che s'inserisca  
negli ambienti  
lavorativi classici.

- EN** An ideal solution for people who are looking for a chair that fits into classical working environments.
- FR** Solution idéale pour ceux qui cherchent un siège s'intégrant aux environnements et ambiances classiques.
- ES** Solución ideal para quienes buscan una silla que sino que simplemente encaje en entornos de trabajo clásicos.

OPERATIVE TASK  
LYBRA STANDARD SWIVEL CHAIR



144T ^ 144T - 143T >





OPERATIVE TASK

## LYBRA STANDARD SWIVEL CHAIR

13SR



144T



143T



MODELLI PER SCRIVANIA MODELS FOR DESK

14T



MODELLI PER TAVOLO ALTO MODELS FOR HIGH DESK

## MISURE E VARIANTI SIZES AND VARIANTS

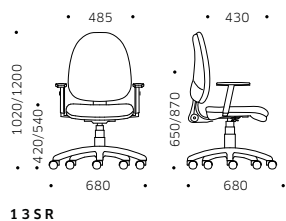

135R

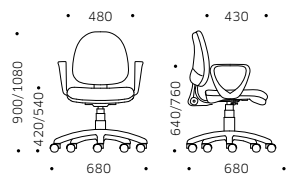

144T

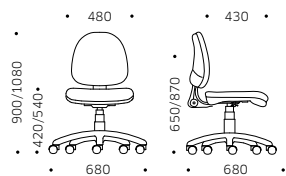

143T

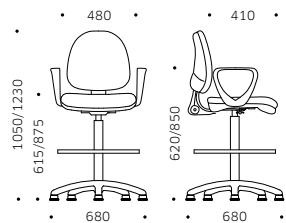

14T

## CERTIFICAZIONI CERTIFICATIONS

D.L. 81/08 EN 1335 Test by CATAS  
Omologazione Ministeriale in Classe 1IM

## FINITURE FINISHES

### PARTI METALLICHE METAL PARTS

Verniciato nero / Black painted / Verni couleur noir / Acabado en negro

### PARTI IN PLASTICA PLASTIC PARTS

Nero / Black / Noir / Negro

### PARTI IN ALLUMINIO ALUMINIUM PARTS

Lucido, verniciato nero o argento (RAL 9006) / Polished, black or silver (RAL 9006) painted / Poli, verni couleur noir, ou argent (RAL 9006) / Pulido, acabado en negro o plateado (RAL 9006)

## ACCESSORI ACCESSORIES

### BRACCIOLO ARMREST

Ad anello o di forma a "T" in polipropilene / Ring or "T"-shaped polypropylene / Accoudoirs en forme d'anneau ou de "T" en polypropylène / En forma de anillo o de "T" en polipropileno

### BASE GIREVOLE SWIVEL BASE

Alluminio a 5 razze / Aluminium 5 stars / Aluminium 5 branches / Aluminio de 5 radios  
Poliamide a 5 razze / Polyamide 5 stars / Polyamide 5 branches / Poliamida de 5 radios

## RIVESTIMENTI COVERINGS



tessuto  
fabric  
tissu  
tela

AG - AR - AL - BR - BB - BL - CR - CT - CE - DB

## DOTAZIONI MECCANICHE TECHNICAL FEATURES

Schienale regolabile in altezza / Sedile regolabile in altezza / Sedile regolabile in profondità / Meccanismo di inclinazione sincronizzata / Meccanismo di inclinazione schienale / Dispositivo regolazione di tensione / Sistema di sicurezza antiritorno / Bracciolo regolabile in altezza / Colonna con anello poggipiedi regolabile in altezza

EN Adjustable backrest / Height adjustable seat / Depth-adjustable seat / Seat and back synchronized inclination mechanism / Backrest inclination mechanism / Device for tension adjustment / Anti-return safety system / Height-adjustable armrest / Column with height-adjustable footrest ring

FR Dossier ajustable en hauteur / Siège réglable en hauteur / Siège réglable en profondeur / Mécanisme d'inclinaison synchronisé du siège et du dossier / Mécanisme d'inclinaison du dossier / Système d'ajustement de la tension / Système de sécurité anti-retour / Accoudoir ajustable en hauteur / Colonne avec repose-pieds ajustable en hauteur

ES Respaldo regulable en altura / Asiento regulable en altura / Asiento regulable en profundidad / Mecanismo de inclinación de asiento y respaldo sincronizada / Mecanismo de inclinación de respaldo / Dispositivo de ajuste de tensión de oscilación / Mecanismo de seguridad anti-retorno / Reposabrazos ajustable en altura / Columna con anillo reposapiés regulable en altura



# SULKY STANDARD SWIVEL CHAIR

Design by Vaghi R&D

Sedia da lavoro  
che combina  
un design sobrio  
e morbido  
con proporzioni  
generose  
e rassicuranti.  
Il suo scopo  
principale  
è quello di essere  
funzionale.

**EN** Task chair that combines understated, soft design with generous, reassuring proportions. Its main purpose is to be functional.

**FR** Siège de travail combinant un design épuré aux lignes douces, avec des volumes généreux et sécurisants. Avant tout opérationnel.

**ES** Silla operativa que combina formas finas y suaves con dimensiones generosas y que dan confianza. Concebida especialmente para áreas de trabajo.

OPERATIVE TASK  
SULKY STANDARD SWIVEL CHAIR



S H S H D < S N N 3 D - S N N 4 D >



OPERATIVE TASK

## SULKY STANDARD SWIVEL CHAIR

SINID



SNP9D



SCHIENALE MEDIO MEDIUM BACK

SHSHD



SNN4D



SNN3D



SCHIENALE BASSO LOW BACK

SNNTF



PTNZF



PTNTF



MODELLI PER TAVOLO ALTO MODELS FOR HIGH DESK



## MISURE E VARIANTI SIZES AND VARIANTS

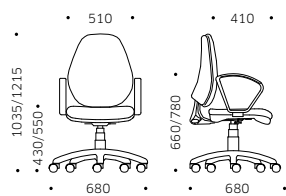

SNP9D

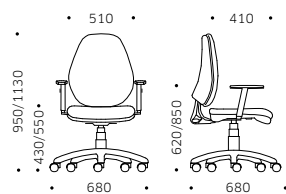

SIN1D

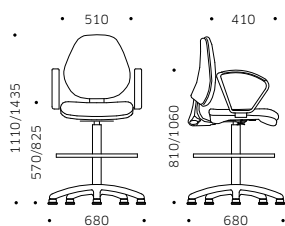

PTNTF / SNNTF

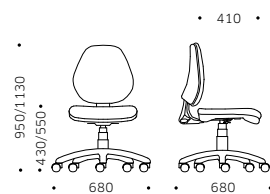

SNN3D

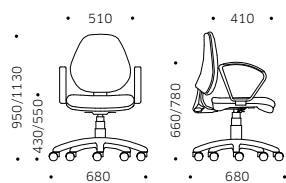

SNN4D

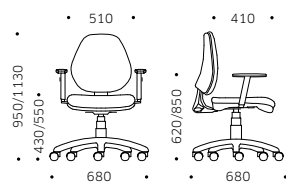

SHSHD

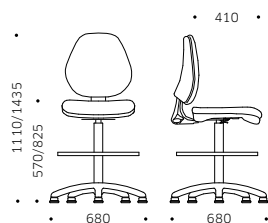

PTNZF

## CERTIFICAZIONI CERTIFICATIONS

D.L. 81/08 EN 1335 Test by CATAS  
Omologazione Ministeriale in Classe 1IM

## FINITURE FINISHES

### PARTI METALLICHE METAL PARTS

Verniciato nero / Black painted / Verni couleur noir / Acabado en negro

### PARTI IN PLASTICA PLASTIC PARTS

Nero / Black / Noir / Negro

### PARTI IN ALLUMINIO ALUMINIUM PARTS

Lucido, verniciato nero o argento (RAL 9006) / Polished, black or silver (RAL 9006) painted / Poli, verni couleur noir, ou argent (RAL 9006) / Pulido, acabado en negro o plateado (RAL 9006)

## ACCESSORI ACCESSORIES

### BRACCIOLO ARMREST

Ad anello in polipropilene / Ring-shaped polypropylene / Accoudoirs en forme d'anneau en polypropylène / En forma de anillo en polipropileno  
Forma a "T" / "T" shaped / En forme de "T" / En forma de "T"

### BASE GIREVOLE SWIVEL BASE

Alluminio a 5 razze / Aluminium 5 stars / Aluminium 5 branches /  
Aluminio de 5 radios  
Poliamide a 5 razze / Polyamide 5 stars / Polyamide 5 branches /  
Poliamida de 5 radios

## RIVESTIMENTI COVERINGS



tessuto  
fabric  
tissu  
tela

AG - AR - AL - BR - BB - BL - CR - CT - CE - DB

## DOTAZIONI MECCANICHE TECHNICAL FEATURES

Schienale regolabile in altezza / Sedile regolabile in altezza / Sedile regolabile in profondità / Meccanismo di inclinazione sincronizzata / Meccanismo di inclinazione schienale / Dispositivo regolazione di tensione / Sistema di sicurezza antiritorno / Bracciolo regolabile in altezza / Colonna con anello poggipiedi regolabile in altezza

EN Adjustable backrest / Height adjustable seat / Depth-adjustable seat / Seat and back synchronized inclination mechanism / Backrest inclination mechanism / Device for tension adjustment / Anti-return safety system / Height-adjustable armrest / Column with height-adjustable footrest ring

FR Dossier ajustable en hauteur / Siège réglable en hauteur / Siège réglable en profondeur / Mécanisme d'inclinaison synchronisé du siège et du dossier / Mécanisme d'inclinaison du dossier / Système d'ajustement de la tension / Système de sécurité anti-retour / Accoudoir ajustable en hauteur / Colonne avec repose-pieds ajustable en hauteur

ES Respaldo regulable en altura / Asiento regulable en altura / Asiento regulable en profundidad / Mecanismo de inclinación de asiento y respaldo sincronizada / Mecanismo de inclinación de respaldo / Dispositivo de ajuste de tensión de oscilación / Mecanismo de seguridad anti-retorno / Reposabrazos ajustable en altura / Columna con anillo reposapiés regulable en altura

OSPITI  
GUEST

**255 LIBERA LI/LC**

**271 GAIO**

**277 WIZARD E GIAVA**

**287 MALTA CONTRACT**

**293 101 RETE**

**301 SULKY 201**

**307 TARIFA 101**



# LIBERA LI/LC MULTIPURPOSE CHAIR



Design by ORLANDINIDESIGN

Il suo design  
invitante  
e confortevole  
offre una posizione  
di seduta in grado  
di bilanciare  
perfettamente  
una postura attiva  
ma al contempo  
rilassata.

- EN** Its inviting and cosy design offers comfortable seating position perfectly balanced between an active and a relaxed posture.
- FR** Attrayant par son design, inspirant le confort, l'assise offre un parfait équilibre entre dynamisme et décontraction.
- ES** Su diseño atractivo y acogedor ofrece una posición de asiento cómoda perfectamente equilibrada entre una postura relajada y una postura activa.



Guarda il video /  
Watch the video



Configura la tua seduta /  
Set up your chair





LI2FN 12PL12 - LI2PC 12PL06 - LC2GN 12PL12 - LI2GB 12PL00 - LC2OT 12PL03 < LC04B 12PL00 A

OSPITI GUEST

## LIBERA LI/LC MULTIPURPOSE CHAIR



LC1GB 11PL00 A LI1TN 11PL22 - LI1QB 11PL00 - LI1PB 11PL05 - LI1PB 11PL22 >





OSPITI GUEST

LIBERA LI/LC MULTIPURPOSE CHAIR



LC20T 12PL03



LC10T 11PL03



LC1GL 11PL06



LC2GL 12PL06

OSPITI GUEST

LIBERA LI/LC MULTIPURPOSE CHAIR



LI1QB 11PL00



LC1QN 11PL12 + LSDNN



LI1PN 11PL27 + LSSNN





OSPITI GUEST

## LIBERA LI/LC MULTIPURPOSE CHAIR

LC04B 12PL00



BASE GIREVOLE SWIVEL BASE

LC2GL 12PL06



LC2GN 12PL12



LI2FN 12PL12



BASE FISSA FIXED BASE

LI2PC 12PL06



LC20T 12PL03





## MODELLI DISPONIBILI AVAILABLE MODELS

### LI

Scocca in plastica a vista  
Plastic shell  
Coque en plastique  
Silla en plastico

### LC

Sedile imbottito  
Padded seat  
Assise rembourée  
Asiento tapizado

## MISURE E VARIANTI SIZES AND VARIANTS

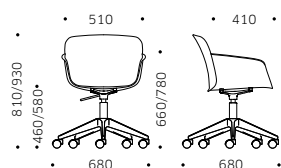

LC04B

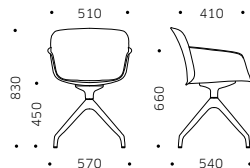

LC2GL / LC2GN

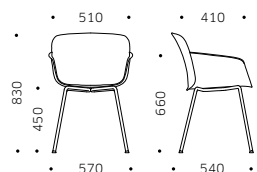

LI2FN

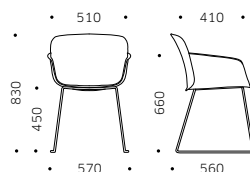

LI2PC

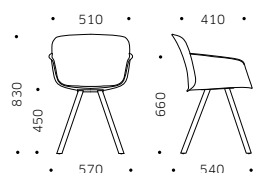

LC20T

## CERTIFICAZIONI CERTIFICATIONS

**EN 16139** **EN 1022** **EN 1728** Test by CATAS  
Omologazione Ministeriale in Classe 1  
Serie LC: Omologazione Ministeriale in Classe 11M

**ANSI - BIFMA X5.4-2020** Test by CATAS

## FINITURE FINISHING

### PARTI METALLICHE METAL PARTS

Cromato, verniciato nero, bianco (RAL 9016) o tortora (RAL 1019) /  
Chromed, black, white (RAL 9016), dove grey (RAL 1019) painted /  
Chrome, verni couleur noir, blanc (RAL 9016) ou gris tourterelle (RAL 1019) /  
Cromo, acabado en negro, blanco (RAL 9016) o gris tórtola (RAL 1019)

### PARTI IN PLASTICA PLASTIC PARTS

Base: nero o bianco (RAL 9003) / Base: black or white (RAL 9003) /  
Pieds: noir ou blanc (RAL 9003) / Base: negra o blanca (RAL 9003)  
Scocca: grigio antracite (RAL 7024), bianco (RAL 9003), blu avio (RAL 5014),  
tortora (RAL 1019), verde oliva (RAL 6003), rosso marrone (RAL 8029)  
Shell: anthracite grey (RAL 7024), white (RAL 9003), pigeon blue  
(RAL 5014), dove grey (RAL 1019), olive green (RAL 6003),  
brown red (RAL 8029)  
Coque: coloris gris anthracite (RAL 7024), blanc (RAL 9003), bleu pigeon  
(RAL 5014), gris tourterelle (RAL 1019), olive verte (RAL 6003),  
rouge brun (RAL 8029)  
Silla: gris antracita (RAL 7024), bianco (RAL 9003), azul colombino  
(RAL 5014), gris tórtola (RAL 1019), verde oliva (RAL 6003),  
rojo marrón (RAL 8029)

### PARTI IN PLASTICA POST CONSUMO PCR PLASTIC PART

Grigio cemento (RAL 9006) / Concrete grey (RAL 9006) / Gris ciment  
(RAL 9006) / Gris cemento (RAL 9006)

### PARTI IN ALLUMINIO ALUMINIUM PARTS

Lucido / Polished / Poli / Pulido

## ACCESSORI ACCESSORIES

### SEDILE SEAT

Imbottito / Upholstered / Rembouré / Tapizado

### BASE GIREVOLE SWIVEL BASE

Alluminio a 5 razze / Aluminium 5 stars / Aluminium 5 branches /  
Aluminio de 5 radios  
Alluminio a 4 razze / Aluminium 4 stars / Aluminium 4 branches /  
Aluminio de 4 radios  
Poliamide a 4 razze / Polyamide 4 stars / Polyamide 4 branches /  
Poliamide de 4 radios  
Poliamide a 5 razze / Polyamide 5 stars / Polyamide 5 branches /  
Poliamide de 5 radios

### BASE FISSA FIXED BASE

Acciaio a 4 gambe / Steel 4 legs / Piètement 4 pieds en acier / 4 patas  
de acero  
Acciaio a slitta / Steel sledge shaped / Traîneau en acier / Tipo trineo  
de acero

## RIVESTIMENTI COVERINGS



AG - AR - AL - BR - BB - BL - CR - CT - CE - DB - ET



EP - FP

## DOTAZIONI MECCANICHE TECHNICAL FEATURES

Sedile regolabile in altezza / Oscillante armonico

- EN** Height adjustable seat / Tilt mechanism
- FR** Siège réglable en hauteur / Mécanisme pivotant
- ES** Asiento regulable en altura / Mecanismo oscilante

OSPITI GUEST

## LIBERA LI/LC MULTIPURPOSE CHAIR

LI1FN 11PL12



BASE FISSA FIXED BASE

LC1TB 11PL27



LC10T 11PL03



LC1GB 11PL00



BASE GIREVOLE SWIVEL BASE

LC1GL 11PL06



LC03D 11PL12



LI1QB 11PL00



BASE FISSA FIXED BASE

LI1PB 12PL27



LISPB 11PL27



LC1QN 11PL12 + LSDNN



LI1PN 11PL27 + LSDNN



BASE FISSA - OPZIONI: TAVOLETTA SCRITTOIO LATO DESTRO O SINISTRO, SISTEMA DI AGGANCIO  
FIXED BASE - OPTIONS: RIGHT OR LEFT SIDE WRITING TABLET,

## MODELLI DISPONIBILI AVAILABLE MODELS

### LI

Scocca in plastica a vista  
Plastic shell  
Coque en plastique  
Silla en plastico

### LC

Sedile imbottito  
Padded seat  
Assise rembourée  
Asiento tapizado

## MISURE E VARIANTI SIZES AND VARIANTS

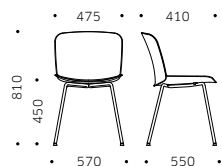

LI11FN

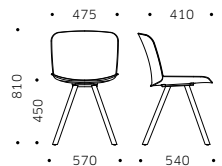

LC10T

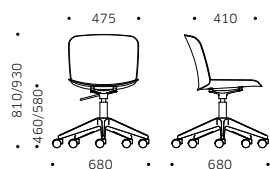

LC03D

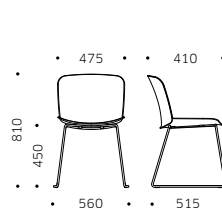

LI11PB / LI11PN

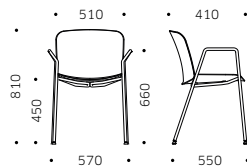

LC1TB

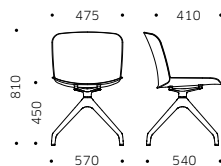

LC1GB / LC1GL

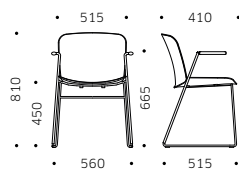

LI1QB / LC1QN

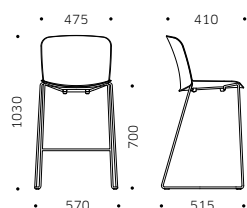

LI1PB

## CERTIFICAZIONI CERTIFICATIONS

EN 16139 EN 1022 EN 1728 Test by CATAS

Omologazione Ministeriale in Classe 1

Serie LC: Omologazione Ministeriale in Classe 11M

## FINITURE FINISHING

### PARTI METALLICHE METAL PARTS

Cromato, verniciato nero, bianco (RAL 9016) o tortora (RAL 1019) /  
Chromed, black, white (RAL 9016), dove grey (RAL 1019) painted /  
Chrome, verni couleur noir, blanc (RAL 9016) ou gris tourterelle (RAL 1019) /  
Cromo, acabado en negro, blanco (RAL 9016) o gris tórtola (RAL 1019)

### PARTI IN PLASTICA PLASTIC PARTS

Base: nero o bianco (RAL 9003) / Base: black or white (RAL 9003) /  
Pieds: noir ou blanc (RAL 9003) / Base: negra o blanca (RAL 9003)  
Scocca: grigio antracite (RAL 7024), bianco (RAL 9003), blu avio (RAL 5014),  
tortora (RAL 1019), verde oliva (RAL 6003), rosso marrone (RAL 8029)  
Shell: anthracite grey (RAL 7024), white (RAL 9003), pigeon blue  
(RAL 5014), dove grey (RAL 1019), olive green (RAL 6003),  
brown red (RAL 8029)  
Coque: coloris gris anthracite (RAL 7024), blanc (RAL 9003), bleu pigeon  
(RAL 5014), gris tourterelle (RAL 1019), olive verte (RAL 6003),  
rouge brun (RAL 8029)  
Silla: gris antracita (RAL 7024), blanco (RAL 9003), azul colombino  
(RAL 5014), gris tórtola (RAL 1019), verde oliva (RAL 6003),  
rojo marrón (RAL 8029)

### PARTI IN PLASTICA POST CONSUMO PCR PLASTIC PART

Grigio cemento (RAL 9006) / Concrete grey (RAL 9006) / Gris ciment  
(RAL 9006) / Gris cemento (RAL 9006)

### PARTI IN ALLUMINIO ALUMINIUM PARTS

Lucido / Polished / Poli / Pulido

## ACCESSORI ACCESSORIES

### SEDILE SEAT

Imbottito / Upholstered / Rembouré / Tapizado

### BASE GIREVOLE SWIVEL BASE

Alluminio a 5 razze / Aluminium 5 stars / Aluminium 5 branches /  
Aluminio de 5 radios  
Alluminio a 4 razze / Aluminium 4 stars / Aluminium 4 branches /  
Aluminio de 4 radios  
Poliamide a 4 razze / Polyamide 4 stars / Polyamide 4 branches /  
Poliamide de 4 radios  
Poliamide a 5 razze / Polyamide 5 stars / Polyamide 5 branches /  
Poliamide de 5 radios

### BASE FISSA FIXED BASE

Acciaio a 4 gambe / Steel 4 legs / Piètement 4 pieds en acier / 4 patas  
de acero  
Acciaio a slitta / Steel sledge shaped / Traîneau en acier / Tipo trineo  
de acero

## RIVESTIMENTI COVERINGS



pelle  
leather  
cuir  
cuero



tessuto  
fabric  
tissu  
tela

EP - FP

AG - AR - AL - BR - BB - BL

CR - CT - CE - DB - ET

## DOTAZIONI MECCANICHE TECHNICAL FEATURES

Sedile regolabile in altezza / Oscillante armonico/ Seduta impilabile /  
Tavoletta scrittoio antipanico / Sistema di aggancio

EN Height adjustable seat / Tilt mechanism / Stackable chair / Anti-panic  
writing tablet / Linking device

FR Siège réglable en hauteur / Mécanisme pivotant / Chaise empilable /  
Tablette écritoir anti-panique / Pièce de liaison

ES Asiento regulable en altura / Mecanismo oscilante / Silla apilable /  
Escritorio antipánico / Sistema de acoplamiento



# GAIO FOLDING TUB CHAIR

Design by ORLANDINIDESIGN

Pratica: si apre e si chiude facilmente; nella posizione aperta è una comoda seduta per riunioni o conferenze dotata di numerosi e utili accessori.

**EN** Practical: it easily opens and closes; in the open position, it is a comfortable chair, with a variety of useful accessories, for meeting or conference rooms.

**FR** Pratique: elle s'ouvre et se replie facilement; en position ouverte, c'est un siège confortable pour les réunions ou les conférences avec de nombreux accessoires utiles.

**ES** Práctica y elegante, esta silla se abre y se pliega fácilmente; en posición abierta, es una silla cómoda para reuniones o conferencias, con una variedad de accesorios útiles.

OSPITI GUEST

## GAIO FOLDING TUB CHAIR



GAF1F + GASDP + GAAGG  $\wedge$  GAF1F + GASDP + GAAGG  $\gt$



OSPITI GUEST

## GAIO FOLDING TUB CHAIR

GAF1F



GAF1F + GASDP



GAF1F + GSSSP + GAAGG



OPZIONI: TAVOLETTA SCRITTOIO LATO DESTRO O SINISTRO, SISTEMA DI AGGANCIO  
OPTIONS: RIGHT OR LEFT SIDE WRITING TABLET, LINKING DEVICE



## MISURE E VARIANTI SIZES AND VARIANTS

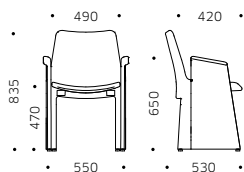

GAF 1 F

## CERTIFICAZIONI CERTIFICATIONS

EN 16139 EN 1022 EN 1728 Test by CATAS  
Omologazione Ministeriale Classe 1IM

## FINITURE FINISHING

### PARTI METALLICHE METAL PARTS

Verniciato nero / Black painted / Verni couleur noir / Acabado en negro

### PARTI IN PLASTICA PLASTIC PARTS

Nero / Black / Noir / Negro

## ACCESSORI ACCESSORIES

### BRACCIOLO ARMREST

Imbottito / Upholstered / Rembouré / Tapizado

### TAVOLETTA SCRITTOIO WRITING TABLET

Polipropilene / Polypropylene / Polypropylène / Polipropileno

### ELEMENTO DI AGGANCIO LINKING DEVICE

Metallo / Metal / Métal / Metal

### TERMINALI ENDS

Ruote o piedini in materiale plastico / Plastic castors or glides / Roulettes ou patins en plastique / Ruedas o patas de plástico

## RIVESTIMENTI COVERINGS



tessuto  
fabric  
tissu  
tela

AG - AL - AR - BR - BB - BL - CT - CE - DB



pelle  
leather  
cuir  
cuero

EP - FP

## DOTAZIONI MECCANICHE TECHNICAL FEATURES

Sedia pieghevole / Tavolettta scrittoio antipánico / Sistema di aggancio / Piedini regolabili in altezza

EN Folding chair / Anti-panic writing tablet / Linking device / Height adjustable feet

FR Chaise pliante / Tablette écritoir anti-panique / Pièce de liaison / Pieds réglables en hauteur

ES Silla plegable / Escritorio antipánico / Sistema de acoplamiento / Patas ajustables en altura



# WIZARD E GIAVA TUB CHAIR

Design by Vaghi R&D

Con le sue  
forme morbide  
è l'ideale per creare  
un'atmosfera  
calda e cordiale,  
avvicinando  
il mondo  
professionale  
a quello domestico.

**EN** The soft shapes make  
it perfect to create a warm  
and friendly atmosphere,  
bringing the office  
and the residential  
environment closer.

**FR** Avec ses formes douces  
c'est idéal pour apporter  
chaleur et convivialité,  
rapprochant l'univers  
professionnel  
du domestique.

**ES** Con sus formas suaves,  
es ideal para aportar  
calidez y convivencia,  
acercando el mundo  
profesional a lo doméstico.

OSPITI GUEST

WIZARD E GIAVA TUB CHAIR



WZOGB



WZ2PB





WZ04B - WZ20W - WZ0GN - WZ2PC - WZ0GL - WZ0DC

OSPITI GUEST

WIZARD E GIAVA TUB CHAIR



GE2PT ^ GE2PT >





OSPITI GUEST

## WIZARD E GIAVA TUB CHAIR

GE2PT



GIAVA, POLTRONA **ARMCHAIR**

WZ20N



WZ2PB



WZ20W



WIZARD, BASE **FISSA** **FIXED** **BASE**

WZ04L



WZ0GL



WZ0GB



WZ0DC



WIZARD, BASE **GIREVOLE** **SWIVEL** **BASE**

## MISURE E VARIANTI SIZES AND VARIANTS

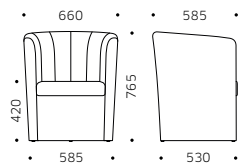

GE2PT

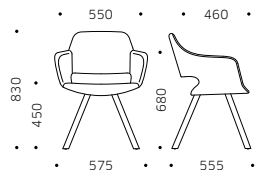

WZ2ON

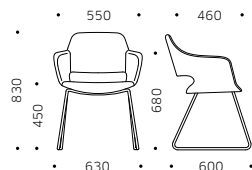

WZ2PC

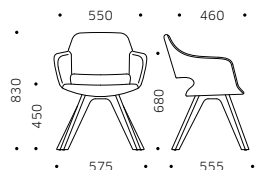

WZ2OW

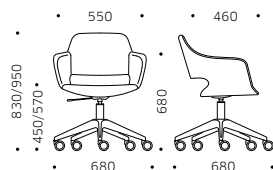

WZ04L

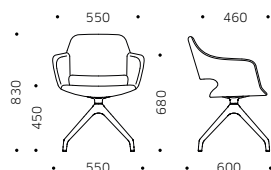

WZ0GB / WZ0GL

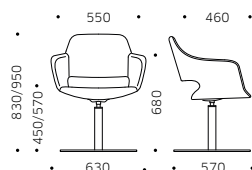

WZ0DC

## CERTIFICAZIONI CERTIFICATIONS

EN 16139 EN 1022 EN 1728 Test by CATAS

## FINITURE FINISHES

### PARTI METALLICHE METAL PARTS

Cromato, verniciato nero o bianco (RAL 9016) / Chromed, black or white (RAL 9016) painted / Chrome, verni couleur noir ou blanc (RAL 9016) / Cromo, acabado en negro o blanco (RAL 9016)

### PARTI IN PLASTICA PLASTIC PARTS

Nero o bianco / Black or white / Noir ou blanc / Negro o blanco

### PARTI IN LEGNO WOODEN PARTS

Faggio / Beechwood / Hêtre / Haya

### PARTI IN ALLUMINIO ALUMINIUM PARTS

Lucido, verniciato nero o bianco (RAL 9016) / Polished, black or white painted (RAL 9016) / Poli, verni couleur noir ou blanc (RAL 9016) / Pulido, acabado en negro o blanco (RAL 9016)

### PARTI IN ACCIAIO INOX STAINLESS STEEL PARTS

Lucido / Polished / Poli / Pulido

## ACCESSORI ACCESSORIES

### BRACCIOLA ARMREST

Imbottito / Upholstered / Rembouré / Tapizado

### BASE GIREVOLE SWIVEL BASE

Alluminio a 5 razze / Aluminium 5 stars / Aluminium 5 branches / Aluminio de 5 radios

Alluminio a 4 razze / Aluminium 4 stars / Aluminium 4 branches / Aluminio de 4 radios

Poliamide a 4 razze / Polyamide 4 stars / Polyamide 4 branches / Poliamida de 4 radios

A disco in acciaio inox / Stainless steel disk / Disk en acier inoxydable / Disco en acero inoxidable

### BASE FISSA FIXED BASE

Acciaio a slitta / Steel sledge shaped / Traîneau en acier / Tipo trineo de acero

Acciaio a 4 gambe / Steel 4 legs / Piètement 4 pieds en acier / 4 patas de acero

Legno a 4 gambe / Wooden 4 legs / Piètement 4 pieds en bois / 4 patas de madera

## RIVESTIMENTI COVERINGS



AG - AR - AL - BR - BB - BL - CT - CE - DB - ET



EP - FP

## DOTAZIONI MECCANICHE MECHANICAL FEATURES

Sedile regolabile in altezza / Oscillante armonico

EN Height adjustable seat / Tilt mechanism

FR Siège réglable en hauteur / Mécanisme pivotant

ES Asiento regulable en altura / Mecanismo oscilante



# MALTA CONTRACT MULTIPURPOSE CHAIR

Design by Vaghi R&D

Grazie al design  
sobrio e moderno  
la linea è sempre  
attuale e si  
inserisce in ogni  
contesto di arredo.

**EN** Its modern, understated design never looks dated and suits perfectly to every business environment.

**FR** Indémodable, met en avant un design sobre et moderne adaptable dans tous les environnements de l'entreprise.

**ES** La gama destaca por un diseño sobrio y moderno, adaptable a todos los ambientes de la empresa.

OSPITI GUEST

MALTA CONTRACT MULTIPURPOSE CHAIR



52SCN ^ 702SN >



OSPITI GUEST

## MALTA CONTRACT MULTIPURPOSE CHAIR

502FN



52SCN



502CC



501CN



SEDILE E SCHIENALE IMBOTTITI PADDED SEAT AND BACK

602FA



601FA



SEDILE IMBOTTITO E SCHIENALE IN PLASTICA A VISTA PADDED SEAT AND SHOW-PLASTIC BACK

702SC



702FB



701FB



SEDILE E SCHIENALE IN PLASTICA A VISTA SHOW-PLASTIC SEAT AND SHOW-PLASTIC BACK



## MODELLI DISPONIBILI AVAILABLE MODELS

### SERIE 5

Sedile e schienale imbottiti  
Padded seat and back  
Dossier et assise rembourrés  
Respaldo y asiento tapizados

### SERIE 6

Sedile imbottito e schienale in plastica a vista  
Padded seat and plastic back  
Dossier en plastique et assise rembourré  
Respaldo con plástico a la vista y asiento tapizado

### SERIE 7

Sedile e schienale in plastica a vista  
Plastic seat and back  
Dossier et assise en plastique  
Respaldo y asiento con plástico a la vista

## MISURE E VARIANTI SIZES AND VARIANTS

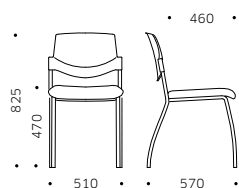

701FB / 601FA

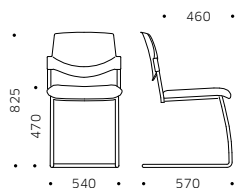

501CN

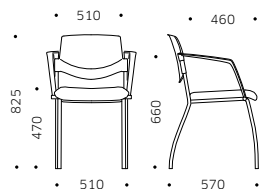

702FB / 602FA / 502FN

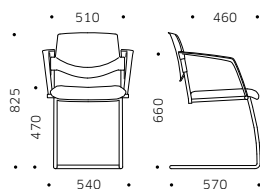

502CC

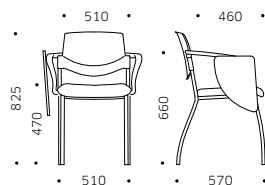

702SC / 702SN

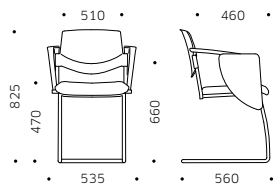

525CN

## CERTIFICAZIONI CERTIFICATIONS

EN 16139 EN 1022 EN 1728 Test by CATAS

## FINITURE FINISHES

### PARTI METALLICHE METAL PARTS

Cromato, verniciato nero, argento (RAL 9006) o bianco (RAL 9003) /  
Chromed, black, silver (RAL 9006) or white (RAL 9003) painted /  
Chrome, verni couleur noir, argent (RAL 9006) ou blanc (RAL 9003) /  
Cromo, acabado en negro, plateado (RAL 9006) o blanco (RAL 9003)

### PARTI IN PLASTICA PLASTIC PARTS

Nero, grigio (RAL 7042) o bianco (RAL 9003) / Black, grey (RAL 7042)  
or white (RAL 9003) / Noir, gris (RAL 7042) ou blanc (RAL 9003) /  
Negro, gris (RAL 7042) o blanco (RAL 9003)

## ACCESSORI ACCESSORIES

### BRACCIOLO ARMREST

Polipropilene / Polypropylene / Polypropylène / Polipropileno  
Poliuretano (per scrittoio) / Polyurethane (for writing tablet) /  
Polyuréthane (pour écritoire) / Poliuretano (para escritorio)

### BASE FISSA FIXED BASE

Acciaio a 4 gambe / Steel 4 legs / Piètement 4 pieds en acier /  
4 patas de acero  
Acciaio a cantilever / Steel cantilever shaped / Piètement luge  
en acier / Tipo trineo de acero

### TAVOLETTA SCRITTOIO WRITING TABLET

Polipropilene / Polypropylene / Polypropylène / Polipropileno

## RIVESTIMENTI COVERINGS



tessuto  
fabric  
tissu  
tela

AG - AR - AL - BR - BB - BL - CR - CT - CE - DB

## DOTAZIONI MECCANICHE TECHNICAL FEATURES

Seduta impilabile / Tavoletta scrittoio antipanico / Sistema di aggancio

EN Stackable chair / Anti-panic writing tablet / Linking device

FR Chaise empilable / Tablette écrivain anti-panique / Pièce de liaison

ES Silla apilable / Escritorio antipánico / Sistema de acoplamiento



# 101 RETE MULTIPURPOSE CHAIR

Design by Vaghi R&D

Linea dal design fluido e leggero, offre una serie di sedute impilabili moderne, in grado di soddisfare le esigenze di incontro e formazione.

- EN** Light and fluid design, offering a highly contemporary series of stackable chairs for visitors, meetings, education and training.
- FR** Arborant une ligne légère et épurée, la gamme propose une série très contemporaine de sièges empilables pour visiteurs, réunion et formation.
- ES** Haciendo gala de una línea ligera y depurada, la gama propone una serie de sillas apilables muy actual para visitas, salas de reunión y formación.





RN1FL - RN2SL < RN1FL + AGGST A

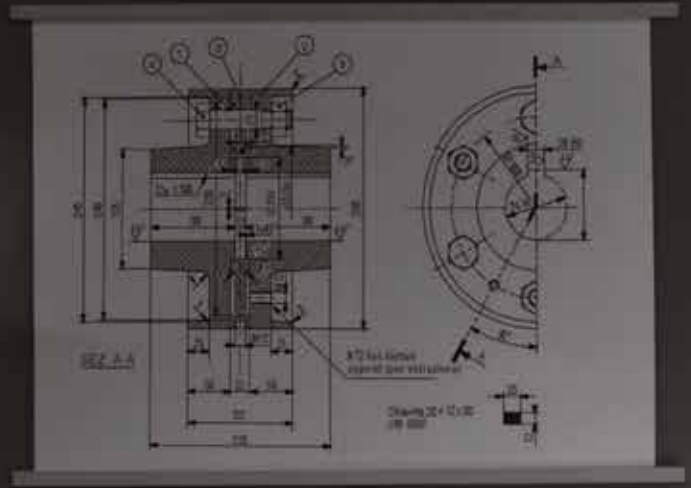

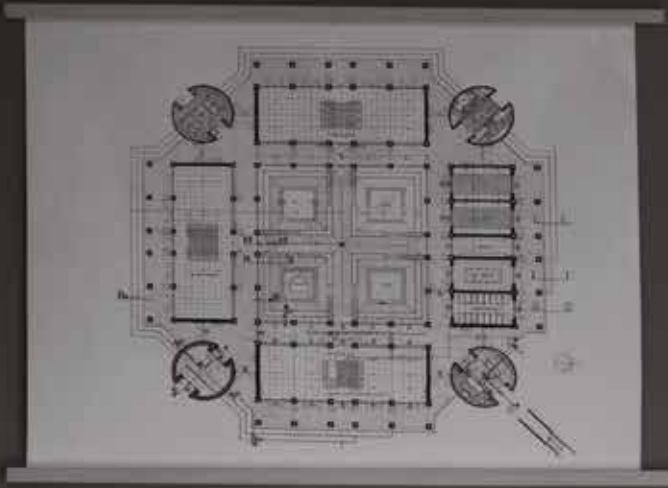

OSPITI GUEST  
101 RETE MULTIPURPOSE CHAIR



BASE A 4 GAMBE 4 LEGS BASE

RN1FL + AGGST / RN1SL + AGGST



SISTEMA DI AGGANCIO LINKING DEVICE



## MISURE E VARIANTI SIZES AND VARIANTS

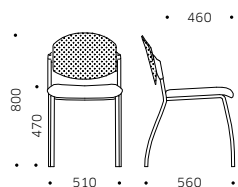

RN1FL

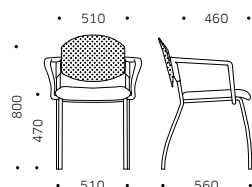

RN2FL

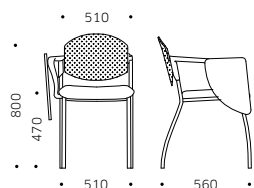

RN1SL

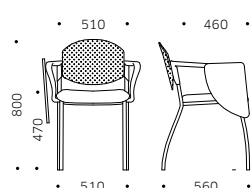

RN2SL

## CERTIFICAZIONI CERTIFICATIONS

EN 16139 EN 1022 EN 1728 Test by CATAS  
Omologazione Ministeriale in Classe 11M

## FINITURE FINISHES

### PARTI METALLICHE METAL PARTS

Cromato, verniciato nero, argento (RAL 9006) / Chromed, black, silver (RAL 9006) / Chrome, verni couleur noir, argent (RAL 9006) / Cromo, acabado en negro, plateado (RAL 9006)

### PARTI IN PLASTICA PLASTIC PARTS

Nero / Black / Noir / Negro

## ACCESSORI ACCESSORIES

### BRACCIOLO ARMREST

Polipropilene / Polypropylene / Polypropylène / Polipropileno  
Poliuretano (per scrittoio) / Polyurethane (for writing tablet) /  
Polyuréthane (pour écritoire) / Poliuretano (para escritorio)

### BASE FISSA FIXED BASE

Acciaio a 4 gambe / Steel 4 legs / Piètement 4 pieds en acier / 4 patas de acero

Acciaio a cantilever / Steel cantilever shaped / Piètement luge en acier / Tipo trineo de acero

### TAVOLETTA SCRITTOIO WRITING TABLET

Polipropilene / Polypropylene / Polypropylène / Polipropileno

## RIVESTIMENTI COVERINGS



AG - AR - AL - BR - BB - BL - CR - CT - CE - DB



RE

## DOTAZIONI MECCANICHE TECHNICAL FEATURES

Seduta impilabile / Tavoletta scrittoio antipanico / Sistema di aggancio

EN Stackable chair / Anti-panic writing tablet / Linking device

FR Chaise empilable / Tablette écritoir anti-panique / Pièce de liaison

ES Silla apilable / Escritorio antipánico / Sistema de acoplamiento



# SULKY 201 MULTIPURPOSE CHAIR

Design by Vaghi R&D

Con il suo design sobrio e tuttavia caratterizzante, è il prodotto di riferimento per arredare spazi di riunione e formazione.

**EN** Its understated and distinctive design makes it the benchmark when it comes to furnishing meeting and training areas.

**FR** Avec son design à la fois sobre et affirmé, est une référence dans l'équipement des espaces de réunion et formation.

**ES** Con su diseño sobrio y con personalidad, es una referencia para salas de reuniones y formación.

OSPITI GUEST

## SULKY 201 MULTIPURPOSE CHAIR



S225C ^ S202C >



OSPITI GUEST

## SULKY 201 MULTIPURPOSE CHAIR

S225C



S202C



S215C



S201C



BASE A 4 GAMBE 4 LEGS BASE

S215C + AGGST / S225C + AGGLU



SISTEMA DI AGGANCIO LINKING DEVICE

## MISURE E VARIANTI SIZES AND VARIANTS

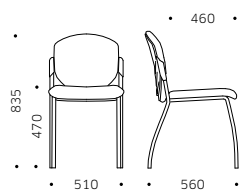

S201C

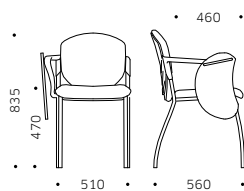

S215C

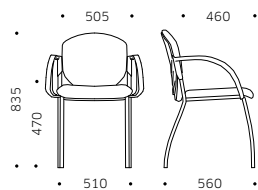

S202C

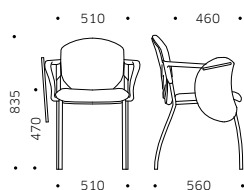

S225C

## CERTIFICAZIONI CERTIFICATIONS

EN 16139 EN 1022 EN 1728 Test by CATAS

## FINITURE FINISHES

### PARTI METALLICHE METAL PARTS

Cromato, verniciato nero, argento (RAL 9006) / Chromed, black, silver (RAL 9006) / Chrome, verni couleur noir, argent (RAL 9006) / Cromo, acabado en negro, plateado (RAL 9006)

### PARTI IN PLASTICA PLASTIC PARTS

Nero / Black / Noir / Negro

## ACCESSORI ACCESSORIES

### BRACCIOLO ARMREST

Polipropilene / Polypropylene / Polypropylène / Polipropileno  
Poliuretano (per scrittoio) / Polyurethane (for writing tablet) /  
Polyuréthane (pour écritoire) / Poliuretano (para escritorio)

### BASE FISSA FIXED BASE

Acciaio a 4 gambe / Steel 4 legs / Piètement 4 pieds en acier /  
4 patas de acero

### TAVOLETTA SCRITTOIO WRITING TABLET

Polipropilene / Polypropylene / Polypropylène / Polipropileno

## RIVESTIMENTI COVERINGS



tessuto  
fabric  
tissu  
tela

AG - AR - AL - BR - BB - BL - CR - CT - CE - DB

## DOTAZIONI MECCANICHE TECHNICAL FEATURES

Seduta impilabile / Tavoletta scrittoio antipanico / Sistema di aggancio

EN Stackable chair / Anti-panic writing tablet / Linking device

FR Chaise empilable / Tablette écritoir anti-panique / Pièce de liaison

ES Silla apilable / Escritorio antipánico / Sistema de acoplamiento





# TARIFA 101 MULTIPURPOSE CHAIR

Design by Vaghi R&D

Vasta gamma di sedute polivalenti, comode ed economiche. Il design sobrio è declinato in molteplici varianti per soddisfare le esigenze di riunione e formazione.

**EN** Wide range of comfortable, affordable, multi-purpose chairs. This understated design comes in many different versions to suit meeting and training areas.

**FR** Large gamme de chaises polyvalents, confortables et économiques. Son design sobre est décliné en multiples modèles pour aménager espaces de réunion et formation.

**ES** Amplia gama de sillas polivalentes, cómodas y económicas. Su sobrio diseño está disponible en múltiples modelos para salas de reuniones y formación.

OSPITI GUEST

TARIFA 101 MULTIPURPOSE CHAIR



102LC



101SC

OSPITI GUEST

## TARIFA 101 MULTIPURPOSE CHAIR

102SC



102C



101SC



101C



SEDILE E SCHIENALE IMBOTTITI, BASE A 4 GAMBE PADDED SEAT AND BACK, 4 LEGS BASE

12SLC



102LC



10SLC



101LC



SEDILE E SCHIENALE LEGNO, BASE A 4 GAMBE WOODEN SEAT AND BACK, 4 LEGS BASE

## MISURE E VARIANTI SIZES AND VARIANTS

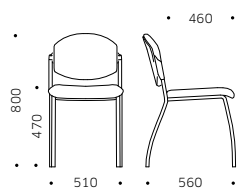

101LC / 101C

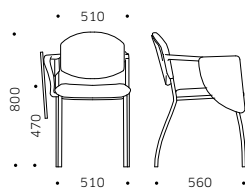

105SLC / 101SC

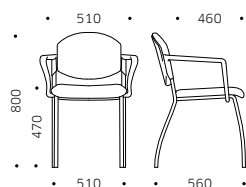

102LC / 102C

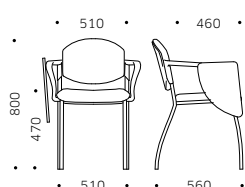

125SLC / 1025C

## CERTIFICAZIONI CERTIFICATIONS

EN 16139 EN 1022 EN 1728 Test by CATAS  
Omologazione Ministeriale in Classe 11M

## FINITURE FINISHES

### PARTI METALLICHE METAL PARTS

Cromato, verniciato nero, argento (RAL 9006) / Chromed, black, silver (RAL 9006) / Chrome, verni couleur noir, argent (RAL 9006) / Cromo, acabado en negro, plateado (RAL 9006)

### PARTI IN PLASTICA PLASTIC PARTS

Nero / Black / Noir / Negro

### PARTI IN LEGNO WOODEN PARTS

Faggio / Beechwood / Hêtre / Haya

## ACCESSORI ACCESSORIES

### BRACCIOLO ARMREST

Polipropilene / Polypropylene / Polypropylène / Polipropileno  
Poliuretano (per scrittoio) / Polyurethane (for writing tablet) /  
Polyuréthane (pour écritoire) / Poliuretano (para escritorio)

### BASE FISSA FIXED BASE

Acciaio a 4 gambe / Steel 4 legs / Piètement 4 pieds en acier /  
4 patas de acero  
Acciaio a cantilever / Steel cantilever shaped / Piètement luge en acier  
/ Tipo trineo de acero

### TAVOLETTA SCRITTOIO WRITING TABLET

Polipropilene / Polypropylene / Polypropylène / Polipropileno  
Legno / Wood / Bois / Madera

## RIVESTIMENTI COVERINGS



tessuto  
fabric  
tissu  
tela

AG - AR - AL - BR - BB - BL - CR - CT - CE - DB

## DOTAZIONI MECCANICHE TECHNICAL FEATURES

Seduta impilabile / Tavoletta scrittoio antipanico / Sistema di aggancio

EN Stackable chair / Anti-panic writing tablet / Linking device

FR Chaise empilable / Tablette écritoir anti-panique / Pièce de liaison

ES Silla apilable / Escritorio antipánico / Sistema de acoplamiento

ATTESE  
WAITING

**315 VIVA BENCH**

**323 MEWA**

**337 MODULIA**

**343 OREOTTO**

**351 MATIS**

**359 ALIAS**

**375 LIBERA LP/LS**

**383 LINEA R**

**389 LINEA TRE**

**397 LINEA M**

**405 COMPLEMENTI COFFEE TABLES**





# VIVA BENCH SOFT SEATING

Design by ORLANDINIDESIGN

Viva Bench  
è unica  
nel suo genere  
per le moltissime  
combinazioni  
realizzabili. Il sistema  
comprende anche  
un elemento divisorio  
fonoassorbente  
rivestito in tessuto  
antibatterico.

**EN** With numerous modules Viva Bench allows more possible combinations than almost any other system. The system consists also of fabric-covered panel screen for visual and acoustic protection.

**FR** Doté de nombreux modules, Viva Bench offre - plus que tout autre système - de larges possibilités de configurations. Le système comprend également un élément de protection visuelle et acoustique revêtus de tissu.

**ES** Con sus numerosos módulos, Viva Bench ofrece tantas posibilidades de combinación como pocos otros sistemas. El sistema también incluye un elemento separador fonoabsorbente tapizado.



Guarda il video /  
Watch the video

ATTESE WAITING  
VIVA BENCH SOFT SEATING



VT20C + VTSCH ^ VTPMN - VTPSN - VT30N + N.2 VTSCH - VT3PN + N.3 VTPTN >







VT1QN + VTSCH - VT40N + N.2 VTSCH - VT30N + N.2 VTSCH

ATTESE WAITING  
VIVA BENCH SOFT SEATING

VT20C + VTSCH



VT1QC + VTSCH



SEDILE E SCHIENALE IMBOTTITI, GAMBA CROMATA UPHOLSTERED SEAT AND BACKREST, CHROMED LEG

VT30A + VTSCH



VT2QA + VTSCH



SEDILE E SCHIENALE IMBOTTITI, GAMBA VERNICIATA ARGENTO UPHOLSTERED SEAT AND BACKREST, SILVER PAINTED LEG

VT40N + VTSCH



VT3QN + VTSCH



SEDILE E SCHIENALE IMBOTTITI, GAMBA IN PLASTICA UPHOLSTERED SEAT AND BACKREST, PLASTIC LEG

VT2PN + VTSCH + VTPTN



VT3PN + VTPTN



SEDILE E SCHIENALE IMBOTTITI, PANNELLO FONASSORBENTE, GAMBA IN PLASTICA UPHOLSTERED SEAT AND BACKREST, ACOUSTIC PANEL, PLASTIC LEG

## MISURE E VARIANTI SIZES AND VARIANTS

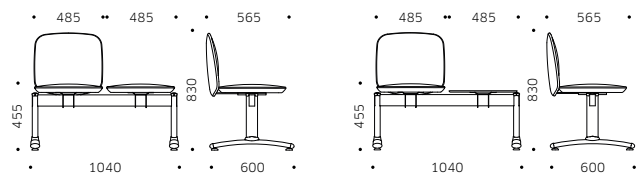

VT20C + VTSCH

VT1QC + VTSCH

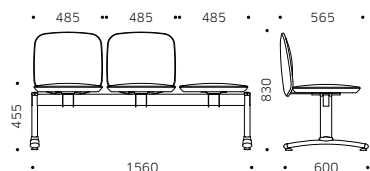

VT30A + VTSCH

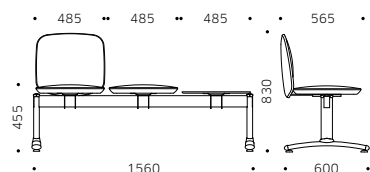

VT2QA + VTSCH

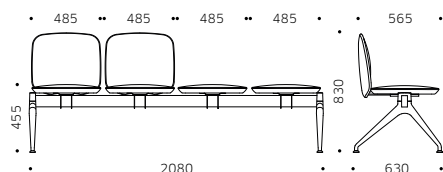

VT40N + VTSCH

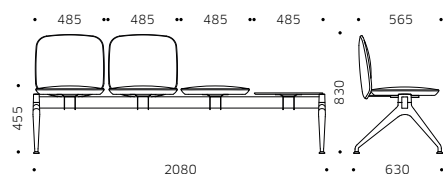

VT3QN + VTSCH

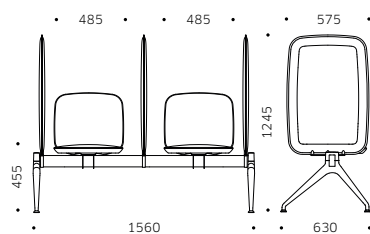

VT2PN + VTSCH + VTPTN

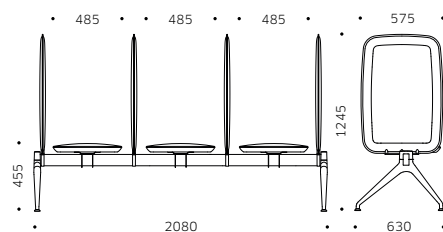

VT3PN + VTPTN

## CERTIFICAZIONI CERTIFICATIONS

EN 16139 EN 1022 EN 1728 Test by CATAS  
Omologazione Ministeriale in Classe 1IM

## FINITURE FINISHES

### PARTI METALLICHE METAL PARTS

Cromato, verniciato nero o argento (RAL 9006) / Chromed, black or silver (RAL 9006) / Chrome, verni couleur noir ou argent (RAL 9006) / Cromo, acabado en negro o plateado (RAL 9006)

### PARTI IN PLASTICA PLASTIC PARTS

Nero / Black / Noir / Negro

### PARTI IN LAMINATO HPL LAMINATED HPL PARTS

Grigio antracite / Anthracite grey / Gris anthracite / Gris antracita

## ACCESSORI ACCESSORIES

### SCHIENALE BACKREST

Imbottito / Upholstered / Rembouré / Tapizado

### BASE BASE

Libera / Free / Libre / Libre

Per fissaggio a suolo / With floor fixing / A vec fixation au sol / Con fijación al suelo

### GAMBA LEG

A V in poliammide / V shaped in polyamide / En forme de T en plastique / De poliamida en forma de V

A T in metallo / T shaped in metal / En forme de T en métal / De metal en forma de T

### TAVOLINO SIDE TABLES

Laminato HPL / Laminated HPL / Stratifié HPL / Laminado HPL

### PANNELLO FONOASSORBENTE ACOUSTIC PANEL

Imbottito con rivestimento antibatterico e ignifugo / Upholstered with antibacterial and fireproof textile / Rembouré avec textile propriétés antibactériennes et ignifuges / Tapizado con textiles antibactericos e ignifugos

## RIVESTIMENTI COVERINGS



tessuto  
fabric  
tissu  
tela

AG - AR - BR - BB - BL - CT - CE - DB - ET



pelle  
leather  
cuir  
cuero

EP - FP

## DOTAZIONI MECCANICHE MECHANICAL FEATURES

Piedini regolabili in altezza

EN Height adjustable feet

FR Pieds réglables en hauteur

ES Patas ajustables en altura

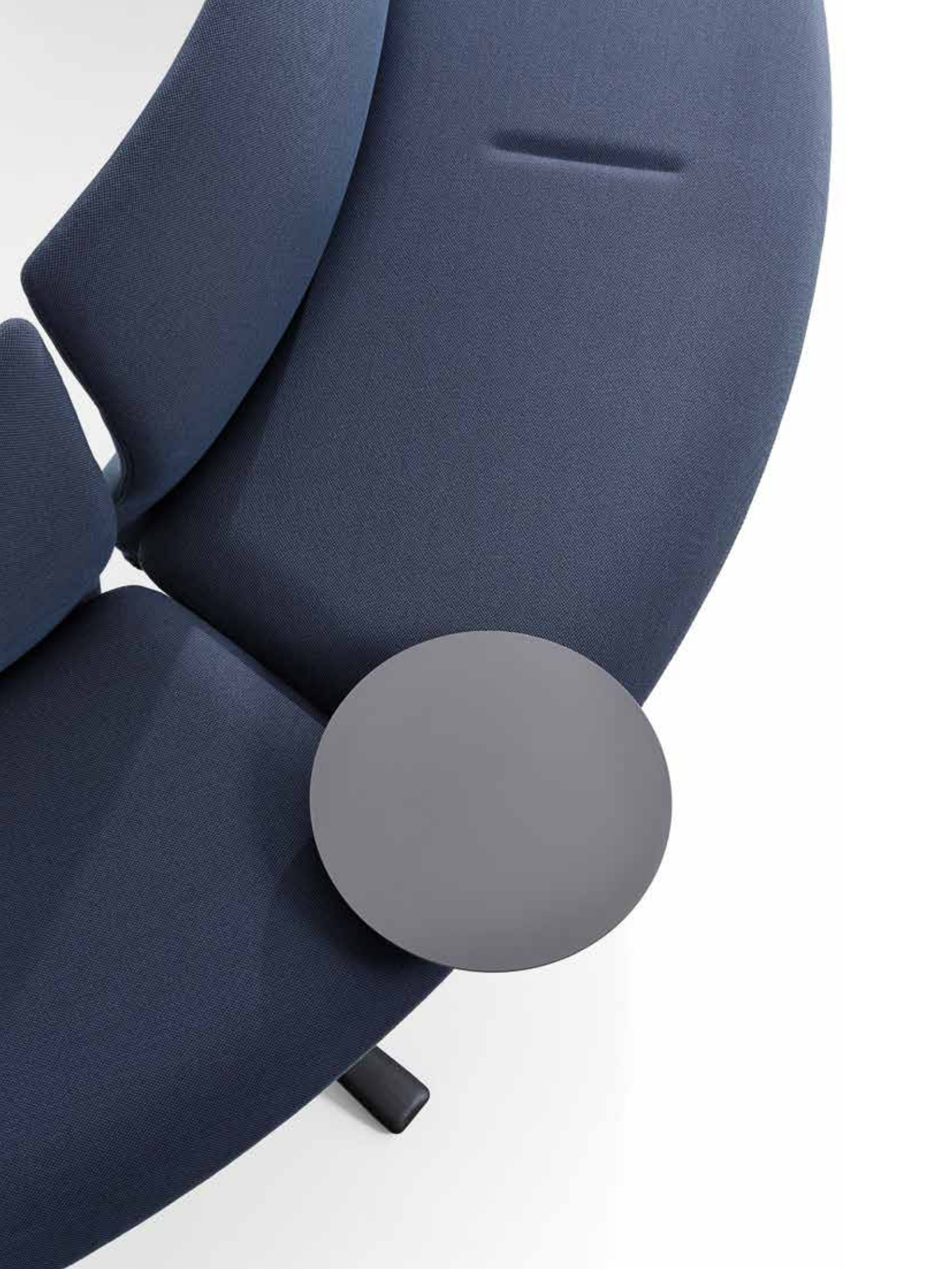



# MEWA MODULAR BENCH SOFT SEATING

Design by Satyendra Pakhalé

Una seduta  
generosa,  
dall'ergonomia  
attiva, crea  
uno spazio unico  
con un'atmosfera  
sensoriale  
che incoraggia  
la coesione  
sociale.

- EN** MeWa System has a generous seat with active ergonomics to create a unique space with a sensorial feel and therefore atmosphere, encouraging the 'social cohesion'.
- FR** Le module MeWa, avec sa assise généreuse et une ergonomie active, crée un espace unique avec une athmosphère agréable qui encourage la 'cohésion'.
- ES** MeWa System tiene un asiento generoso con ergonomía activa para crear un espacio único con una sensación sensorial y por lo tanto la atmósfera, alentando la 'cohesión social'.



Guarda il video /  
Watch the video





< ML2DB - MMSGN ^ ML2DM + MMTGN

ATTESE WAITING

## MEWA MODULAR BENCH SOFT SEATING



SNAKE - ML2PN + MMTGN + MMCON + MMLGN ^ ML2DM - ML2PM - MMSGN >



ATTESE WAITING

## MEWA MODULAR BENCH SOFT SEATING



TRIANGLE - ML2DM + MMTGN + MMCON + MMLGN



CIRCLE - ML2DM + ML2PM + MMCON







ATTESE WAITING

## MEWA MODULAR BENCH SOFT SEATING

ML2DL



ML2DM



ML2DN + MMTGN



DIVANO A DUE POSTI TWO SEATER BENCH WITH BACKREST

ML2PL



ML2PN



ML2PM



ML2PB



PANCA A DUE POSTI TWO SEATER BENCH

## MISURE E VARIANTI SIZES AND VARIANTS

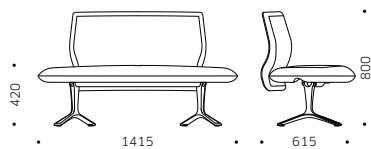

ML2DN / ML2DL / ML2DM



ML2PN / ML2PL / ML2PM / ML2PB

## CERTIFICAZIONI CERTIFICATIONS

EN 16139 EN 1022 EN 1728 Test by CATAS  
Omologazione Ministeriale in Classe 11M

## FINITURE FINISHES

### PARTI METALLICHE METAL PARTS

Verniciato nero / Black painted / Verni couleur noir /  
Acabado en negro

### PARTI IN ALLUMINIO ALUMINIUM PARTS

Lucido, verniciato nero o bianco o bronzo / Polished, black or white  
or bronze painted / Poli, verni couleur noir ou blanc ou bronze /  
Pulido, acabado en negro o blanco o bronce

### PARTI IN PLASTICA PLASTIC PARTS

Nero / Black / Noir / Negro

### PARTI IN LAMINATO HPL LAMINATED HPL PARTS

Grigio antracite / Anthracite grey / Gris anthracite / Gris antracita

## ACCESSORI ACCESSORIES

### TAVOLINO SIDE TABLES

Laminato HPL / Laminated HPL / Stratifié HPL / Laminado HPL

## RIVESTIMENTI COVERINGS



AG - AR - BR - BB - BL - CT - CE - DB - ET



EP - FP

## DOTAZIONI MECCANICHE MECHANICAL FEATURES

Piedini regolabili in altezza

EN Height adjustable feet  
FR Pieds réglables en hauteur  
ES Patas ajustables en altura

ATTESE WAITING

## MEWA MODULAR BENCH SOFT SEATING

### ELEMENTI E ACCESSORI ELEMENTS AND ACCESSORIES

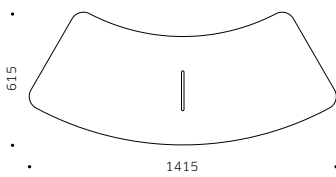

**ML2P**

**Panca a 2 posti**  
2 seater bench

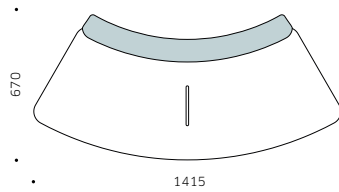

**ML2D**

**Divano a 2 posti**  
2 seater bench with backrest

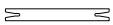

**MMCON**

**Giunto corto per trave**  
Short linking device for bench

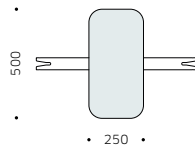

**MMSGN**

**Giunto medio per trave  
con tavolino rettangolare**  
Medium linking device for bench,  
with rectangular table

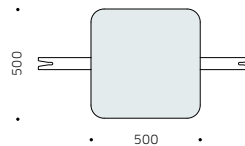

**MMLGN**

**Giunto lungo per trave  
con tavolino quadrato**  
Long linking device for bench,  
with squared table

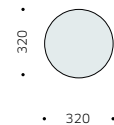

**MMTGN**

**Tavolino laterale**  
Side table

ESEMPI DI COMPOSIZIONE EXAMPLES OF COMPOSITION

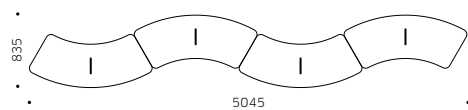

SNAKE - N.4 ML2PN + N.3 MMCON

**Panca a doppia curva a 8 posti**  
8 seater double shaped bench

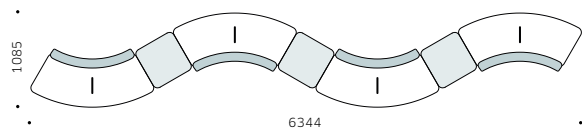

SNAKE - N.4 ML2DN + N.3 MMLGN

**Divano a doppia curva a 8 posti con schienali contrapposti e tavolini quadrati intermedi**  
8 seater double shaped bench with opposite backrest and 3 middle rectangular tables

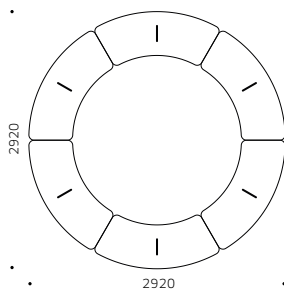

CIRCLE - N.6 MLPDN + N.6 MMCON

**Panca circolare a 12 posti**  
12 seater round shaped bench

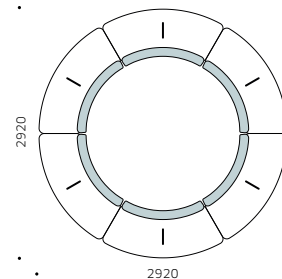

CIRCLE- N.6 MLPDN + N.6 MMCON

**Divano circolare a 12 posti con 3 tavolini quadrati intermedi**  
12 seater round shaped bench with backrest

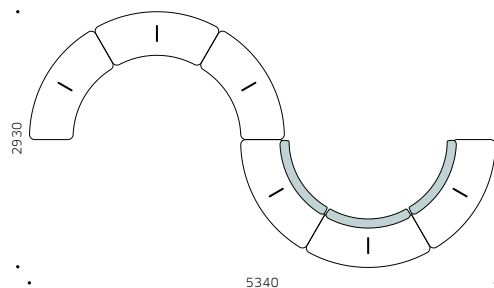

FREE-FORM - N.3 ML2PN + N.3 ML2DN + N.5 MMCON

**Panca e divano semicircolare a 12 posti**  
12 seater halfround shaped bench and sofa

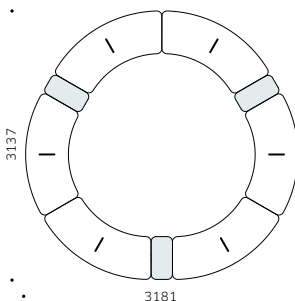

TRIANGLE - N.6 ML2PN + N.6 MMSGN

**Panca circolare a 12 posti con 3 tavolini rettangolari intermedi**  
12 seater round shaped bench with 3 middle rectangular tables

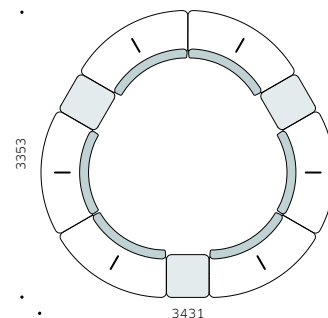

TRIANGLE - N.6 ML2DN + N.6 MMLGN

**Divano circolare a 12 posti con 3 tavolini quadrati intermedi**  
12 seater round shaped bench with backrests and 3 middle squared tables

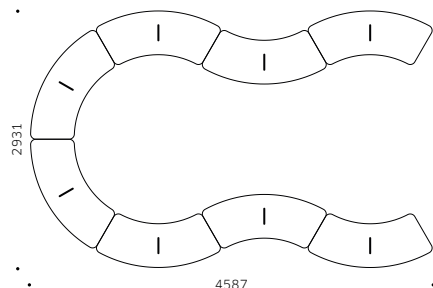

FREE-FORM - N.8 ML2PN + N.7 MMCON

**Panca a doppia curva a 16 posti**  
16 seater double shaped bench

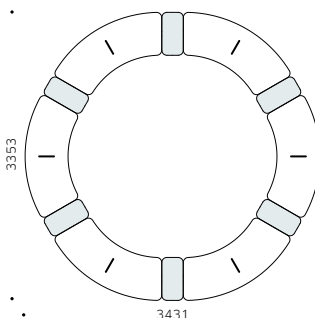

DAISY - N.6 ML2PN + N.6 MMSGN

**Panca circolare a 12 posti con 6 tavolini rettangolari intermedi**  
12 seater round shaped bench with 6 middle rectangular tables

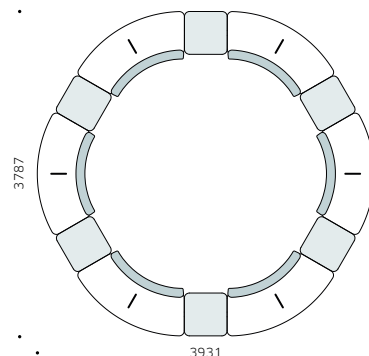

DAISY - N.6 ML2DN + N.6 MMLGN

**Divano circolare a 12 posti con 6 tavolini quadrati intermedi**  
12 seater round shaped bench with 6 middle squared tables



# MODULIA MODULAR SOFT SEATING

Design by RADICEORLANDINI designstudio

Elemento  
modulare solido  
e gradevole  
che si adatta  
perfettamente  
a qualsiasi  
spazio reception.  
Disponibile  
con tavolino  
di cortesia.

**EN** Sturdy, good-looking modular soft seating, it can be arranged to suit every type of reception area. Matching side tables.

**FR** Modulaires, très solides et esthétiques, s'adaptent parfaitement à tout espace d'accueil. Tables basses assorties.

**ES** Modulares, sólidas y estéticas, se adaptan a cualquier espacio de recepción. Mesitas a juego.



Configura la tua seduta /  
Set up your chair

ATTESE WAITING  
MODULIA MODULAR SOFT SEATING

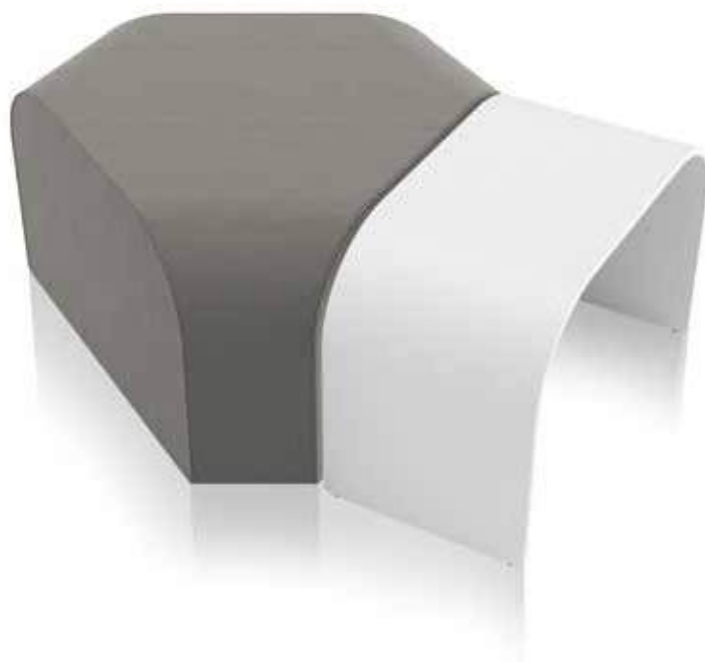

MOSTF + MOTRB ^ MOSTF + MOTRB >





ATTESE WAITING  
MODULIA MODULAR SOFT SEATING

**MOSTF**



**POUF** POUFS

**MOTRB**



**TAVOLINO** SIDE TABLE

## MISURE E VARIANTI SIZES AND VARIANTS

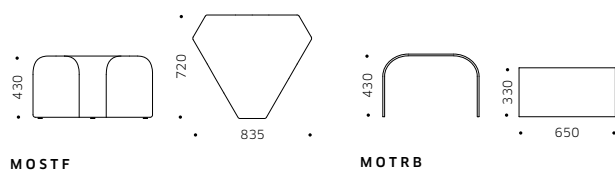

## CERTIFICAZIONI CERTIFICATIONS

EN 16139 EN 1022 EN 1728 EN 1730 Test by CATAS

## FINITURE FINISHING

### PARTI IN PLASTICA PLASTIC PARTS

Nero / Black / Noir / Negro

### PARTI IN LEGNO WOODEN PARTS

Grigio antracite o bianco (RAL 9003) / Grey anthracite or white (RAL 9003) / Gris anthracite ou blanc (RAL 9003) / Gris antracita o blanco (RAL 9003)

## ACCESSORI ACCESSORIES

### TAVOLINO SIDE TABLE

Faggio / Beechwood / Hêtre / Haya

### TERMINALI GLIDES

Materiale plastico / Plastic / En plastique / Patas de plástico

## RIVESTIMENTI COVERINGS



tessuto  
fabric  
tissu  
tela

AG - AR - AL - BR - BB - BL - CT - CE - DB



pelle  
leather  
cuir  
cuero

EP - FP

## DOTAZIONI MECCANICHE TECHNICAL FEATURES

Piedini regolabili in altezza

- EN Height adjustable feet
- FR Pieds réglables en hauteur
- ES Patas ajustables en altura



# OREOTTO SOFT SEATING

Design by Vaghi R&D

Il design della  
gamba in metallo  
ne esalta  
la forma semplice  
e si raccorda  
armoniosamente  
al taglio smussato  
dello schienale.

**EN** The design of the metal leg emphasises the simple shape and is the perfect counterpart to the bevelled cut of the backrest.

**FR** Le design de son piétement souligne la simplicité de ses formes et s'accorde harmonieusement avec les coupes biseautées de son dossier.

**ES** El diseño de su pata subraya la sencillez de sus líneas y combina perfectamente con los cortes biselados de su respaldo.





810MC < 820MC ^







ATTESE WAITING  
OREOTTO SOFT SEATING

810MC



POLTRONA ARMCHAIR

820MC



830MC



DIVANO A 2 E 3 POSTI 2 AND 3-SEATER SOFA

## MISURE E VARIANTI SIZES AND VARIANTS

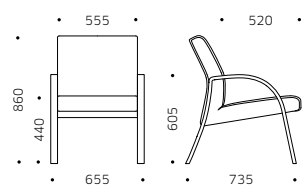

810MC

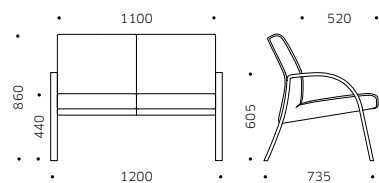

820MC

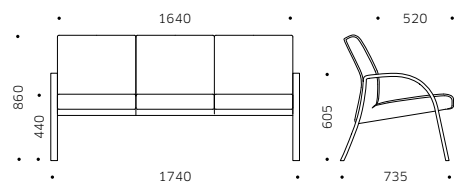

830MC

## CERTIFICAZIONI CERTIFICATIONS

EN 16139 EN 1022 EN 1728 Test by CATAS  
Omologazione Ministeriale in Classe 1IM - UNI 9175

## FINITURE FINISHES

### PARTI METALLICHE METAL PARTS

Cromato, verniciato nero o bianco (RAL 9016) / Chromed, black or white (RAL 9016) painted / Chrome, verni couleur noir ou blanc (RAL 9016) / Cromo, acabado en negro o blanco (RAL 9016)

### PARTI IN PLASTICA PLASTIC PARTS

Nero / Black / Noir / Negro

## ACCESSORI ACCESSORIES

### BRACCIOLO ARMREST

Aperto / Open / Ouvert / Abiertos

### CUSCINI CUSHIONS

Fissi / Fixed / Fixes / Fijos

### TERMINALI GLIDES

Materiale plastico / Plastic / En plastique / Patas de plástico

## RIVESTIMENTI COVERINGS



AG - AR - AL - BR - BB - BL - CT - CE - DB - ET



EP - FP



# MATIS SOFT SEATING

Design by Vaghi R&D

Armonia classica,  
forme diritte  
e grande comfort  
per questo divano  
di qualità.  
Con un'eleganza  
che non passa  
mai di moda,  
veste ogni spazio  
di attesa.

- EN** Classy sofa offering harmonious shapes, straight lines and superb comfort. Its timeless elegance beautifully enhances every waiting area.
- FR** Harmonie classique, formes droites et superbe confort pour ce canapé de standing. Par son élégance indémodable, habille tous les espaces d'attente.
- ES** Armonía clásica, formas rectas y gran confort para este sofá de calidad. Con una elegancia que no pasa de moda, viste todo tipo de zonas de espera.

ATTESE WAITING  
MATIS SOFT SEATING



MA11L ^ MA33L >









ATTESE WAITING  
MATIS SOFT SEATING

MA11L



MA11N



POLTRONA ARMCHAIR

MA22L



MA22N



DIVANO A 2 POSTI 2-SEATER SOFA

MA33L



MA33N



DIVANO A 3 POSTI 3-SEATER SOFA

## MISURE E VARIANTI SIZES AND VARIANTS

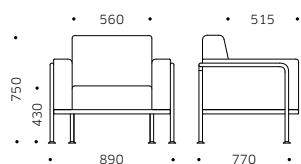

MA11L / MA11N

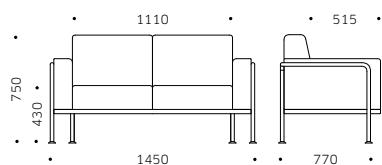

MA22L / MA22N

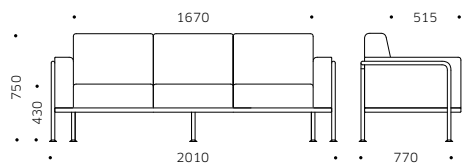

MA33L / MA33N

## CERTIFICAZIONI CERTIFICATIONS

EN 16139 EN 1022 EN 1728 Test by CATAS  
Omologazione Ministeriale in Classe 1IM - UNI 9175

## FINITURE FINISHES

### PARTI METALLICHE METAL PARTS

Cromato, verniciato nero o bianco (RAL 9016) / Chromed, black or white (RAL 9016) painted / Chrome, verni couleur noir ou blanc (RAL 9016) / Cromo, acabado en negro o blanco (RAL 9016)

### PARTI IN PLASTICA PLASTIC PARTS

Nero / Black / Noir / Negro

## ACCESSORI ACCESSORIES

### BRACCIOLO ARMREST

Imbottito / Upholstered / Rembouré / Tapizado

### CUSCINI CUSHIONS

Amovibili / Removable / Amovibles / Extraibles

### TERMINALI GLIDES

Materiale plastico / Plastic / En plastique / Patas de plástico

## RIVESTIMENTI COVERINGS



tessuto  
fabric  
tissu  
tela

AG - AR - AL - BR - BB - BL - CT - CE - DB - ET



pelle  
leather  
cuir  
cuero

EP - FP



# ALIAS SOFT SEATING

Design by Vaghi R&D

Sedute per l'attesa:  
una concezione  
intelligente  
improntata  
alla semplicità,  
flessibilità,  
modularità,  
comfort ed alla  
valorizzazione  
degli spazi.

**EN** Modular soft seating: its intelligent concept is driven by simplicity, flexibility, modularity, comfort and improvement of space.

**FR** Sièges modulaires: dont concept particulièrement intelligent est basé sur la simplicité, la flexibilité, la modularité, le confort et la valorisation des espaces.

**ES** Asientos modulares: su concepto inteligente es impulsado por la simplicidad, la flexibilidad, la modularidad, el confort y el deseo de la valorización de el espacio.



Configura la tua seduta /  
Set up your chair





AS2ML - AS1ML < AS1MB ^











AS20W < AS10B ^

ATTESE WAITING  
ALIAS SOFT SEATING



AS1DB ▲ PM09F - PM06F - PM12F >







ATTESE WAITING  
ALIAS SOFT SEATING

AS1MB



AS2MB



POLTRONA E DIVANO ARMCHAIR AND SOFA

AS10B



AS20B



AS30B



POLTRONA E DIVANO ARMCHAIR AND SOFA

AS10W



AS20W



POLTRONA E DIVANO ARMCHAIR AND SOFA

AS1DB



AS2DB+ATRBB



AS1SB



AS2SB + ATRBB



SEDUTE MODULARI ASIMMETRICHE ASYMMETRIC MODULAR SEATING

PM06F



PM09F



PM12F



POUF OTTOMAN



## MODELLI DISPONIBILI AVAILABLE MODELS

### AM/AS

Poltrona e divano / Armchair and sofa / Fauteuil et canapé / Sillón y sofá

### ASM

Sedute modulari asimmetriche / Asymmetric modular seating / Sièges modulaires asymétriques / sillas modulares asimétricas

### PM

Pouf / Ottoman / Poufs / Pufs

## CERTIFICAZIONI CERTIFICATIONS

EN 16139 EN 1022 EN 1728 Test by CATAS

Omologazione Ministeriale in Classe 1IM

## FINITURE FINISHES

### PARTI METALLICHE METAL PARTS

Cromato, verniciato nero, bianco (RAL 9016) o tortora (RAL 1019) / Chromed, black, white (RAL 9016), dove grey (RAL 1019) painted / Chrome, verni couleur noir, blanc (RAL 9016) ou gris tourterelle (RAL 1019) / Cromo, acabado en negro, blanco (RAL 9016) o gris tórtola (RAL 1019)

### PARTI IN ALLUMINIO ALUMINIUM PARTS

Lucido, verniciato nero, bianco (RAL 9016) o tortora (RAL 1019) / Polished, black, white (RAL 9016), dove grey (RAL 1019) painted / Poli, verni couleur noir, blanc (RAL 9016) ou gris tourterelle (RAL 1019) / Pulido, acabado en negro, blanco (RAL 9016) o gris tórtola (RAL 1019)

### PARTI IN PLASTICA PLASTIC PARTS

Nero / Black / Noir / Negro

### PARTI IN LEGNO WOODEN PARTS

Faggio / Beechwood / Hêtre / Haya

### PARTI IN LAMINATO HPL LAMINATED HPL PARTS

Grigio (RAL 7039) o bianco (RAL 9003) / Grey (RAL 7039) or white (RAL 9003) painted / Gris (RAL 7039) ou blanc (RAL 9003) / Gris (RAL 7039) o blanco (RAL 9003)

## ACCESSORI ACCESSORIES

### BRACCIOLO ARMREST

Imbottito / Upholstered / Rembouré / Tapizado

### CUSCINI CUSHIONS

Amovibili / Removable / Amovibles / Extraibles

### TAVOLINO SIDE TABLE

Laminato HPL / Laminated HPL / Stratifié HPL / Laminado HPL

### GAMBA LEG

Alluminio / Aluminium / Aluminium / Aluminio  
Legno / Wood / Bois / Madera

### TERMINALI GLIDES

Materiale plastico / Plastic / En plastique / Patas de plástico

## RIVESTIMENTI COVERINGS



tessuto  
fabric  
tissu  
tela

AG - AR - AL - BR - BB - BL - CT - CE - DB - ET



pelle  
leather  
cuir  
cuero

EP - FP

ATTESE WAITING  
**ALIAS SOFT SEATING**

**MISURE E VARIANTI SIZES AND VARIANTS**

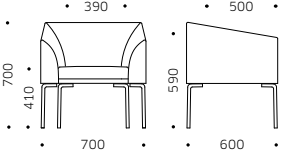

**AS1ML**

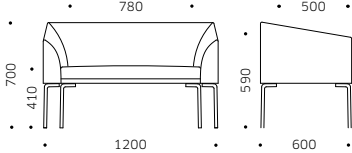

**AS2ML**

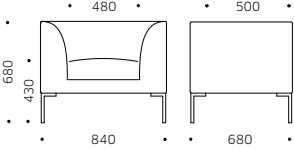

**AS10L / AS10W**

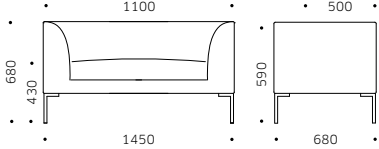

**AS20L / AS20W**

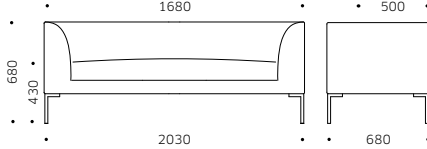

**AS30L**

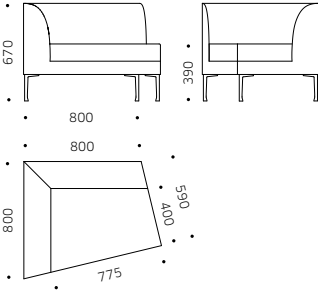

**AS1DL**

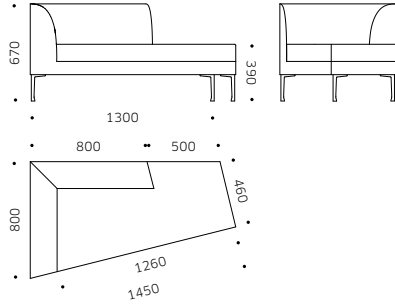

**AS2DL**

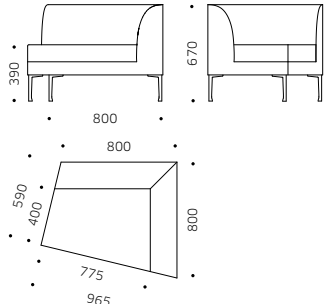

**AS1SB**

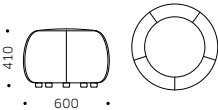

**PM06F**

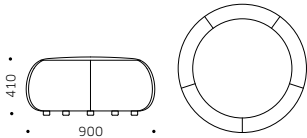

**PM09F**

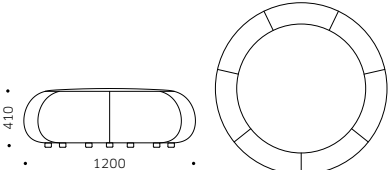

**PM12F**

**ESEMPI DI COMPOSIZIONE EXAMPLES OF COMPOSITION**

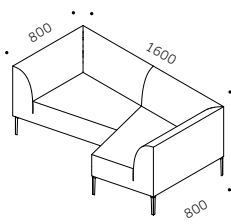

**N. 2 AS1DL**

**modulo a 2 posti contigui**  
 2 seater adjoining module  
 module à 2 sièges joints  
 módulo de 2 plazas  
 contiguas

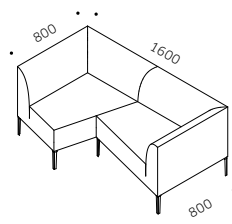

**N. 2 AS1SL**

**modulo a 2 posti contigui**  
 2 seater adjoining module  
 module à 2 sièges joints  
 módulo de 2 plazas  
 contiguas

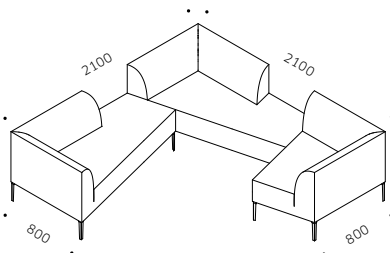

**N. 2 AS2DL + N. 1 AS1DL**

**angolare 3 posti contigui  
 con allungo laterale**  
 3 seater corner  
 composition  
 angolare a 3 sièges  
 joints avec allonge latérale  
 esquinero de 3 plazas  
 contiguas, con  
 prolongación lateral

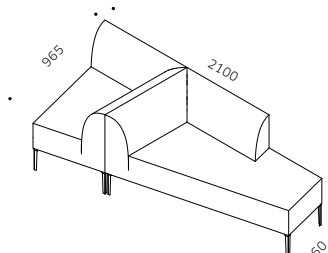

**AS1DL+AS2DL**

**modulo a 2 posti singoli,  
 con allungo laterale**  
 2 seater single module,  
 with side extension  
 module à 2 sièges isolés,  
 avec allonge latérale  
 módulo de 2 plazas  
 individuales, con  
 prolongación lateral

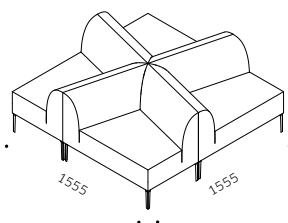

**N. 4 AS1DL**

**isola a 4 posti singoli**  
 4 single seater  
 composition  
 île à 4 sièges isolés  
 isla de 4 plazas  
 individuales

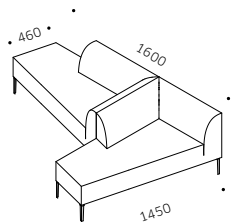

**N. 2 AS1SL**

**modulo a 2 posti singoli,  
 con allungo laterale**  
 2 seater single module,  
 with side extension  
 module à 2 sièges isolés,  
 avec allonge latérale  
 módulo de 2 plazas  
 individuales, con  
 prolongación lateral

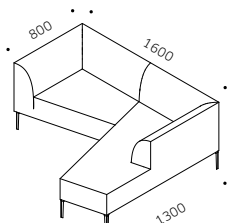

**AS1DL+AS2DL**

**modulo a 2 posti contigui,  
 con allungo laterale**  
 2 seater angular  
 composition  
 module à 2 sièges joints,  
 avec allonge latérale  
 módulo de 2 plazas  
 contiguas, con  
 prolongación lateral

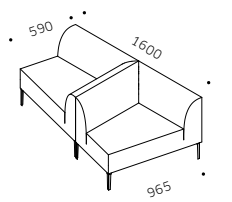

**N. 2 AS1SL**

**modulo a 2 posti singoli**  
 2 seater single module  
 module à 2 sièges isolés  
 módulo de 2 plazas  
 individuales



# LIBERA LP/LS BENCH SEATING SYSTEM

Design by ORLANDINIDESIGN

Montata su trave,  
la scocca Libera  
si trasforma  
in un sistema  
modulare  
per sale d'attesa.  
I vari colori  
della scocca  
offrono molteplici  
possibilità di  
combinazione.

**EN** Mounted on a base beam,  
Libera shell is transformed into  
a modular system for waiting  
areas. Different shell colours  
provide a multitude of possible  
combinations.

**FR** La coque Libera fixée sur une  
poutre devient un système  
modulaire pour zones d'attente.  
Différentes couleurs de coque  
offrent une multitude de  
combinaisons possibles.

**ES** Montada sobre un travesaño,  
el cuerpo Libera se convierte  
en un sistema modular para  
zonas de espera. Los diferentes  
colores permiten obtener  
multitud de combinaciones.



Guarda il video /  
Watch the video

ATTESE WAITING  
LIBERA LP/LS BENCH SEATING SYSTEM



LS20N 11PL27



LP30A 11PL03







ATTESI WAITING

## LIBERA LP/LS BENCH SEATING SYSTEM

LS20N 11PL27



LS1QN 11PL27



SCOCCA CON CUSCINO, GAMBA IN PLASTICA SEAT WITH CUSHION, PLASTIC LEG

LP30A 11PL03



LP2QA 11PL03



SCOCCA A VISTA, GAMBA VERNICIATA ARGENTO PLASTIC SEAT, SILVER PAINTED LEG

LP40C 11PL12



LP3QC 11PL12



SCOCCA A VISTA, GAMBA CROMATA PLASTIC SEAT, CHROMED LEG

## MODELLI DISPONIBILI AVAILABLE MODELS

### LP

Scocca in polipropilene  
Polypropylene shell  
Coque en plastic  
Silla en plastico

### LS

Scocca in polipropilene con cuscino sedile  
Polypropylene shell with padded seat  
Coque en plastic avec assise rembourée  
Silla en plastico y asiento tapizado

## MISURE E VARIANTI SIZES AND VARIANTS

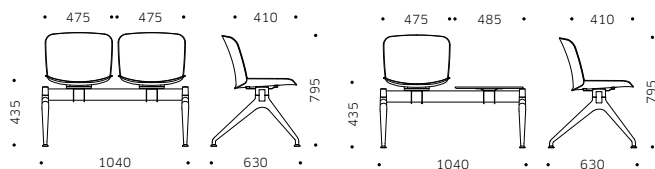

LS20N

LS1QN

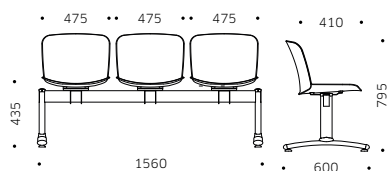

LP30A

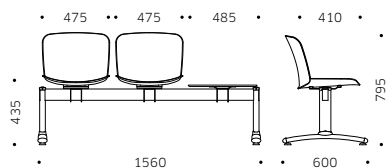

LP2QA

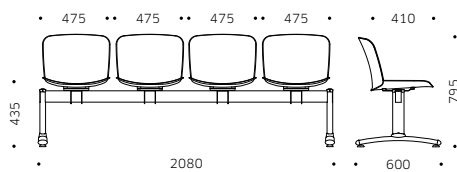

LP40C

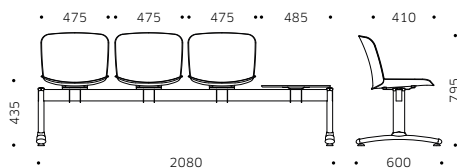

LP3QC

## CERTIFICAZIONI CERTIFICATIONS

**EN 16139** **EN 1022** **EN 1728** Test by CATAS  
Omologazione Ministeriale in Classe 1

Serie LS: Omologazione Ministeriale in Classe 1IM

## FINITURE FINISHES

### PARTI METALLICHE METAL PARTS

Cromato, verniciato nero o argento (RAL 9006) / Chromed, blackor silver (RAL 9006) / Chrome, verni couleur noir ou argent (RAL 9006) / Cromo, acabado en negro o plateado (RAL 9006)

### PARTI IN PLASTICA PLASTIC PARTS

Nero / Black / Noir / Negro

Scocca: grigio antracite (RAL 7024), bianco (RAL 9003), blu avio (RAL 5014), tortora (RAL 1019), verde oliva (RAL 6003), rosso marrone (RAL 8029)

Shell: anthracite grey (RAL 7024), white (RAL 9003), pigeon blue (RAL 5014), dove grey (RAL 1019), olive green (RAL 6003), brick red (RAL 8029)

Coque: coloris gris anthracite (RAL 7024), blanc (RAL 9003), bleu pigeon (RAL 5014), gris tourterelle (RAL 1019), olive verte (RAL 6003), rouge brun (RAL 8029)

Silla: gris antracita (RAL 7024), blanco (RAL 9003), azul colombino (RAL 5014), gris tórtola (RAL 1019), verde oliva (RAL 6003), rojo marrón (RAL 8029)

### PARTI IN PLASTICA POST CONSUMO PCR PLASTIC PARTS

Scocca: Grigio cemento (RAL 9006) / Shell: Concrete grey (RAL 9006) / Coque: gris ciment (RAL 9006) / Silla: gris cemento (RAL 9006)

### PARTI IN LAMINATO HPL LAMINATED HPL PARTS

Grigio antracite / Anthracite grey / Gris anthracite / Gris antracita

## ACCESSORI ACCESSORIES

### CUSCINI CUSHIONS

Fissi / Fixed / Fixes / Fijos

### BASE BASE

Libera / Free / Libre / Libre

Per fissaggio a suolo / With floor fixing / A vec fixation au sol / Con fijación al suelo

### GAMBA LEG

A V in poliammide / V shaped in polyamide / En forme de T en plastique / De poliamida en forma de V

A T in metallo / T shaped in metal / En forme de T en métal / De metal en forma de T

### TAVOLINO SIDE TABLES

Laminato HPL / Laminated HPL / Stratifié HPL / Laminado HPL

### TERMINALI GLIDES

Materiale plastico / Plastic / En plastique / Patas de plástico

## RIVESTIMENTI COVERINGS



**AG - AR - AL - BR - BB - BL - CR - CT - CE - DB - ET**



**EP - FP**

## DOTAZIONI MECCANICHE MECHANICAL FEATURES

Piedini regolabili in altezza

**EN** Height adjustable feet

**FR** Pieds réglables en hauteur

**ES** Patas ajustables en altura



# LINEA R BENCH SEATING SYSTEM

Design by Vaghi R&D

Definita da un design essenziale, che ne sottolinea leggerezza e volumi sottili, è ideale per le aree reception e le sale d'attesa.

- EN** Defined by an understated design which underscores its lightness and slim volumes, it's perfect for highly frequented reception areas and waiting rooms.
- FR** Définie par un design essentiel qui en souligne la légèreté et la finesse des volumes, elle est idéale pour les espaces d'accueil et les salles d'attente.
- ES** Definida por un diseño esencial, que remarca la ligereza y los volúmenes finos, es ideal para zonas de recepción y salas de espera.

ATTESE WAITING  
LINEA R BENCH SEATING SYSTEM



RN1TL ^ RN20L >

a

U  
C - R  
e  
n A



ATTESE WAITING  
LINEA R BENCH SEATING SYSTEM

RN1TL



1 POSTO 1-SEATER

RN2TL



2 POSTI 2-SEATER

RN20L



RN3TL



3 POSTI 3-SEATER

RN30L



RN40L



4 POSTI 4-SEATER



## MISURE E VARIANTI SIZES AND VARIANTS

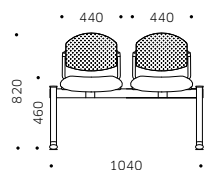

RN20L

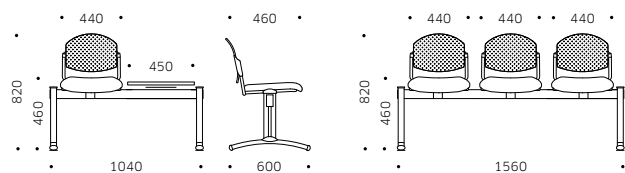

RN1TL

RN30L

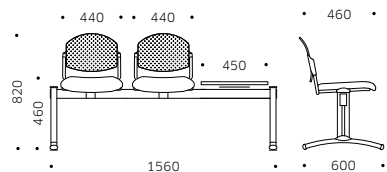

RN2TL

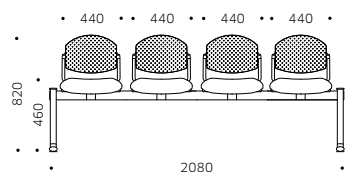

RN40L

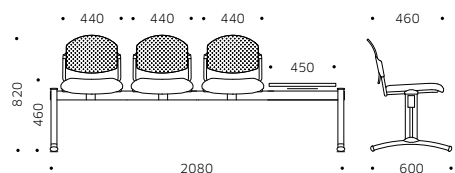

RN3TL

## CERTIFICAZIONI CERTIFICATIONS

EN 16139 EN 1022 EN 1728 Test by CATAS

## FINITURE FINISHES

### PARTI METALLICHE METAL PARTS

Cromato, verniciato nero o argento (RAL 9006) / Chromed, black or silver (RAL 9006) / Chrome, verni couleur noir ou argent (RAL 9006) / Cromo, acabado en negro o plateado (RAL 9006)

### PARTI IN PLASTICA PLASTIC PARTS

Nero / Black / Noir / Negro

### PARTI IN LAMINATO LAMINATED PARTS

Grigio antracite / Anthracite grey / Gris anthracite / Gris antracita

## ACCESSORI ACCESSORIES

### BRACCIOLO ARMREST

Polipropilene / Polypropylene / Polypropylène / Polipropileno  
Poliuretano (per scrittoio) / Polyurethane (for writing tablet) /  
Polyuréthane (pour écritoire) / Poliuretano (para escritorio)

### BASE BASE

Libera / Free / Libre / Libre  
Per fissaggio a suolo / With floor fixing / Avec fixation au sol /  
Con fijación al suelo

### TAVOLETTA SCRITTOIO WRITING TABLET

Polipropilene / Polypropylene / Polypropylène / Polipropileno

### TAVOLINO SIDE TABLE

Laminato HPL / Laminated HPL / Stratifié HPL / Laminado HPL

### TERMINALI GLIDES

Materiale plastico / Plastic / En plastique / Patas de plástico

## RIVESTIMENTI COVERINGS



tessuto  
fabric  
tissu  
tela

AG - AR - AL - BR - BB - BL - CE - CR - CT - DB - ET



rete  
netting  
réseau  
red

RE

## DOTAZIONI MECCANICHE TECHNICAL FEATURES

Piedini regolabili in altezza / Tavolettta scrittoio antipanico

EN Height adjustable feet / Anti-panic writing tablet

FR Pieds réglables en hauteur / Tablette écritoir anti-panique

ES Patas ajustables en altura / Escritorio antipánico



# LINEA TRE BENCH SEATING SYSTEM

Design by Vaghi R&D

Gli elementi sono studiati per dare il più alto grado di resistenza e solidità, ed al contempo la massima leggerezza estetica.

**EN** The elements are studied to achieve the maximum level of strength and solidity, together with the highest aesthetics lightness.

**FR** Les éléments sont étudiés pour apporter une résistance et une solidité élevées, tout en favorisant la légèreté sur le plan esthétique.

**ES** Los elementos están diseñados para ofrecer el más alto nivel de resistencia y solidez, a la vez que la máxima ligereza estética.





LM2TA - LM30A - LM40A < LL30A ^





ATTESE WAITING  
LINEA TRE BENCH SEATING SYSTEM

LM1TA



1 POSTO 1-SEATER

LM2TA



2 POSTI 2-SEATER

LM20A



LM3TA

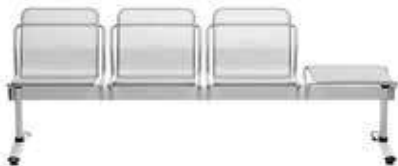

3 POSTI 3-SEATER

LM30A



LM40A

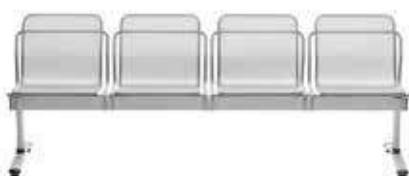

4 POSTI 4-SEATER

LL30A



SEDILE E SCHIENALE IMBOTTITI PADDED SEAT AND BACK



## MISURE E VARIANTI SIZES AND VARIANTS

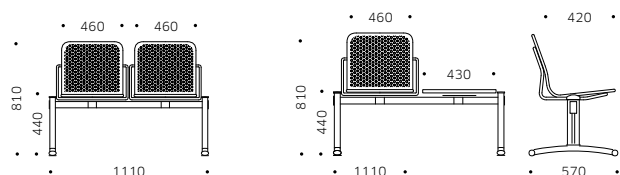

LM20A

LM1TA

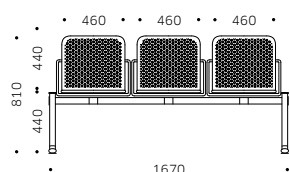

LL30A / LM30A

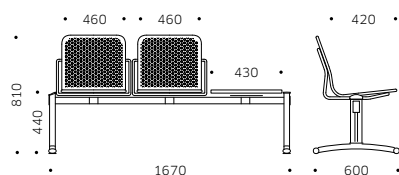

LM2TA

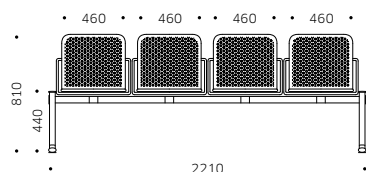

LM40A

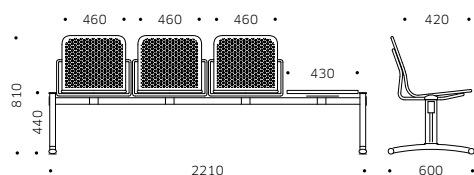

LM3TA

## CERTIFICAZIONI CERTIFICATIONS

EN 16139 EN 1022 EN 1728 Test by CATAS

## MODELLI DISPONIBILI AVAILABLE MODELS

### LL

Sedile e schienale imbottiti / Padded seat and back / Dossier et assise rembourrés / Respaldo y asiento tapizados

### LM

Sedile e schienale in metallo / Metal seat and back / Dossier et assise en métal / Respaldo y asiento con metal

## FINITURE FINISHES

### PARTI METALLICHE METAL PARTS

Verniciato nero o argento (RAL 9006) / Black or silver (RAL 9006) / Verni couleur noir ou argent (RAL 9006) / Acabado en negro o plateado (RAL 9006)

### PARTI IN PLASTICA PLASTIC PARTS

Nero / Black / Noir / Negro

### PARTI IN LAMINATO LAMINATED PARTS

Grigio antracite / Anthracite grey / Gris anthracite / Gris antracita

## ACCESSORI ACCESSORIES

### CUSCINI CUSHIONS

Fissi / Fixed / Fixes / Fijos

### TAVOLINO SIDE TABLE

Laminato HPL / Laminated HPL / Stratifié HPL / Laminado HPL

### BASE BASE

Libera / Free / Libre / Libre

Per fissaggio a suolo / With floor fixing / Avec fixation au sol / Con fijación al suelo

### TERMINALI GLIDES

Materiale plastico / Plastic / En plastique / Patas de plástico

## RIVESTIMENTI COVERINGS



tessuto  
fabric  
tissu  
tela

AG - AR - AL - BR - BB - BL - CR - CT - CE - DB - ET

## DOTAZIONI MECCANICHE TECHNICAL FEATURES

Piedini regolabili in altezza

EN Height adjustable feet

FR Pieds réglables en hauteur

ES Patas ajustables en altura



# LINEA M BENCH SEATING SYSTEM

Design by Vaghi R&D

Fresca e moderna,  
questa gamma  
di panche  
polivalenti  
e comode  
è ideale per  
le aree reception  
e le sale d'attesa  
molto frequentate.

**EN** This refreshingly modern range of comfortable and multi-purpose beam seating is perfect for highly frequented reception areas and waiting rooms.

**FR** Fraîche et moderne cette gamme de poutres confortables et polyvalentes est idéale pour les espaces d'accueil et les salles d'attente notamment à forte fréquentation.

**ES** Fresca y modern, a esta gama de bancadas polivalentes y comodas es ideal para zonas de recepción, salas de espera incluso de mucho tránsito.

ATTESE WAITING  
LINEA M BENCH SEATING SYSTEM



M540N + TBRPS + TBRST ^ M720L - M730L - M740L >







ATTESE WAITING  
LINEA M BENCH SEATING SYSTEM

M520N



M530N + TBR02



M540N+TBRPS+TBRST



SEDILE E SCHIENALE IMBOTTITI PADDED SEAT AND BACK

M61TA



M62TA



M63TA



SEDILE IMBOTTITO E SCHIENALE IN PLASTICA A VISTA PADDED SEAT AND SHOW-PLASTIC BACK

M720L



M730L



M740L



SEDILE E SCHIENALE IN PLASTICA A VISTA SHOW-PLASTIC BACK AND SEAT



## MISURE E VARIANTI SIZES AND VARIANTS

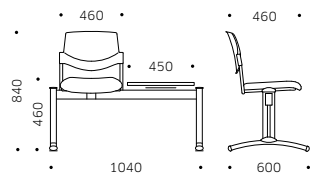

M61TA

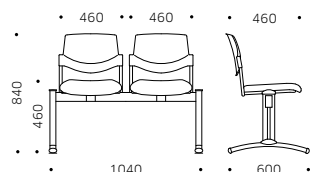

M720L / M520N

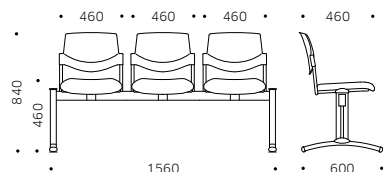

M730L / M530N

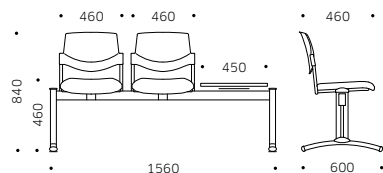

M62TA

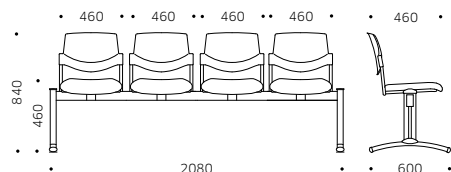

M740L | M540N

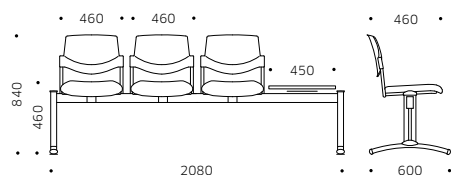

M63TA

## CERTIFICAZIONI CERTIFICATIONS

EN 16139 EN 1022 EN 1728 Test by CATAS

## MODELLI DISPONIBILI AVAILABLE MODELS

### SERIE 5

Sedile e schienale imbottiti / Padded seat and back / Dossier et assise rembourrés / Respaldo y asiento tapizados

### SERIE 6

Sedile imbottito e schienale in plastica a vista / Padded seat and plastic back / Dossier en plastique et assise rembourré / Respaldo con plástico a la vista y asiento tapizado

### SERIE 7

Sedile e schienale in plastica a vista / plastic back and seat / Dossier et assise en plastique / Respaldo y asiento con plástico a la vista

## FINITURE FINISHES

### PARTI METALLICHE METAL PARTS

Cromato, verniciato nero o argento (RAL 9006) / Chromed, black or silver (RAL 9006) / Chrome, verni couleur noir ou argent (RAL 9006) / Cromo, acabado en negro o plateado (RAL 9006)

### PARTI IN PLASTICA PLASTIC PARTS

Nero, grigio (RAL 7042) o bianco (RAL 9003) / Black, grey (RAL 7042) or white (RAL 9003) / Noir, gris (RAL 7042) ou blanc (RAL 9003) / Negro, gris (RAL 7042) o blanco (RAL 9003)

### PARTI IN LAMINATO LAMINATED PARTS

Grigio antracite / Anthracite grey / Gris anthracite / Gris antracita

## ACCESSORI ACCESSORIES

### BRACCIOLO ARMREST

Polipropilene / Polypropylene / Polypropylène / Polipropileno  
Poliuretano (per scrittoio) / Polyurethane (for writing tablet) / Polyuréthane (pour écritoire) / Poliuretano (para escritorio)

### BASE BASE

Libera / Free / Libre / Libre  
Per fissaggio a suolo / With floor fixing / Avec fixation au sol / Con fijación al suelo

### TAVOLETTA SCRITTOIO WRITING TABLET

Polipropilene / Polypropylene / Polypropylène / Polipropileno

### TAVOLINO SIDE TABLE

Laminato HPL / Laminated HPL / Stratifié HPL / Laminado HPL

### TERMINALI GLIDES

Materiale plastico / Plastic / En plastique / Patas de plástico

## RIVESTIMENTI COVERINGS



tessuto  
fabric  
tissu  
tela

AG - AR - AL - BR - BB - BL - CR - CT - CE - DB - ET

## DOTAZIONI MECCANICHE TECHNICAL FEATURES

Piedini regolabili in altezza / Tavolettta scrittoio antipánico

EN Height adjustable feet / Anti-panic writing tablet

FR Pieds réglables en hauteur / Tablette écritoir anti-panique

ES Patas ajustables en altura / Escritorio antipánico



# COMPLEMENTI COFFEE TABLES

Design by ALALDA\_design & Vaghi R&D

I tavolini, utili  
piani di appoggio,  
completano gli  
arredi imbottiti  
in modo ottimale,  
inserendosi  
armoniosamente  
nel quadro  
d'insieme.

**EN** Side tables, useful support surfaces, are optimally matched to the upholstered furniture and fit into the overall picture harmoniously.

**FR** Les tables d'appoint, qui permettent de poser dossiers et autres objets, complètent les éléments rembourrés et se fondent harmonieusement dans l'espace.

**ES** Las mesas laterales, utiles para colocar objetos, encajan a la perfección con el mobiliario tapizado y generan una imagen global de armonía.



Configura il tuo prodotto /  
Set up your product

ATTESE WAITING  
FILO COFFEE TABLES



TM3GN ^ TM5BC - TM3GN - TM5GT - TM3BB >



ATTESE WAITING  
CALICE COFFEE TABLES



TT1GL ^ TT1DC + TT1PC - TT1BB >



ATTESE WAITING  
QUADRO COFFEE TABLES



TQ1GL ^ TR1GB - TQ1BW - TR2GT >





ATTESE WAITING  
COMPLEMENTI COFFEE TABLES

TM3GN

TM5GN

TM3BB

TM5BB

TM3GT

TM5GT

TM3BC

TM5BC



FILO - STRUTTURA IN METALLO METAL FRAME

Design by ALALDA\_design

TT1DC + TT1PC

TT1GL

TT1BB



CALICE - BASE A DISCO DISK BASE

TQ1GL

TR1GL

TR2GL



QUADRO - GAMBA IN ALLUMINIO ALUMINIUM LEG

TQ1BW

TR1BW

TR2BW



QUADRO - GAMBA IN LEGNO WOODEN LEG

## MODELLI DISPONIBILI AVAILABLE MODELS

### FILO

Struttura in metallo verniciato, piano in HPL / Painted metal frame, with HPL top / Structure en métal vernis et plan en HPL / Estructura de metal lacada y tapa de HPL

### CALICE

Base a disco e piano in vetro o HPL / Disk base, with glass or HPL top / Base de disque et plan en verre ou HPL / Base de disco y tapa de cristal o HPL

### QUADRO

Gambe in alluminio o legno e piano in legno laccato antigraffio / Aluminium or wooden legs and anti-scratch lacquered wood top / Pieds en aluminium ou en bois et plan en bois laqué antirayure / Patas de aluminio o madera y tapa de madera lacada antirrayado

## MISURE E VARIANTI SIZES AND VARIANTS

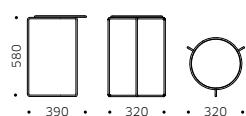

TM3GN / TM3BB / TM3GT / TM3BC



TM5GN / TM5BB / TM5GT / TM5BC

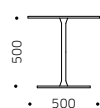

TT1BL / TT1GL / TT1DC +TT1PC

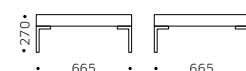

TQ1GL



TR1GL

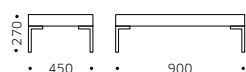

TR2GL

## CERTIFICAZIONI CERTIFICATIONS

EN 15372 EN 1730 Test by CATAS

## FINITURE FINISHES

### PARTI METALLICHE METAL PARTS

Cromato verniciato nero, bianco (RAL 9016) o tortora (RAL 1019) / Chromed, black, white (RAL 9016) or dove grey painted (RAL 1019) / Chrome, verni couleur noir, blanc (RAL 9016) ou gris tourterelle (RAL 1019) / Cromo, acabado en negro, blanco (RAL 9016) o gris tórtola (RAL 1019)

### PARTI IN ALLUMINIO ALUMINIUM PARTS

Lucido, verniciato nero, bianco (RAL 9016) o tortora (RAL 1019) / Polished, black, white (RAL 9016) or dove grey painted (RAL 1019) / Poli, verni couleur noir, blanc (RAL 9016) ou gris tourterelle (RAL 1019) / Pulido, acabado en negro, blanco (RAL 9016) o gris tórtola (RAL 1019)

### PARTI IN PLASTICA PLASTIC PARTS

Nero / Black / Noir / Negro

### PARTI IN VETRO GLASS PARTS

Trasparente / Clear / Transparent / Transparente

### PARTI IN LAMINATO HPL LAMINATED HPL PARTS

Grigio (RAL 7039) o bianco (RAL 9003) / Grey (RAL 7039) or white (RAL 9003) painted / Gris (RAL 7039) ou blanc (RAL 9003) / Gris (RAL 7039) o blanco (RAL 9003)

### PARTI IN LEGNO WOODEN PARTS

Grigio ardesia (RAL 7015) o bianco (RAL 9003) / Slate grey (RAL 7015) or white (RAL 9003) / Gris ardoise (RAL 7015) ou blanc (RAL 9003) / Gris pizarra (RAL 7015) o blanco (RAL 9003) / Faggio / Beechwood / Hêtre / Haya

## ACCESSORI ACCESSORIES

### PIANO TOP

Laminato HPL / Laminated HPL / Stratifié HPL / Laminado HPL  
Vetro temperato / Tempered glass / Verre trempé / Cristal templado  
Legno / Wood / Bois / Madera

### BASE A DISCO DISK BASE

Acciaio inox / Stainless steel / Acier inoxydable / Acero inoxidable

### GAMBA LEG

Alluminio / Aluminium / Aluminium / Aluminio  
Acciaio / Steel / Acier / Acero  
Faggio / Beechwood / Hêtre / Haya

### TERMINALI GLIDES

Materiale plastico / Plastic / En plastique / Patas de plástico

PELLI E TESSUTI  
FABRICS AND LEATHERS

# LEGENDA LEGEND

## DATI TECNICI TECHNICAL DATA

1. CARATTERISTICHE
2. COMPOSIZIONE
3. PESO
4. REAZIONE AL FUOCO
5. ABRASIONE
6. SPESSORE

- EN**
1. FEATURES
  2. COMPOSITION
  3. WEIGHT
  4. FIRE TEST
  5. ABRASION
  6. THICKNESS

- FR**
1. CARACTÉRISTIQUES
  2. COMPOSITION
  3. POIDS
  4. RÉACTION AU FEU
  5. ABRASION
  6. ÉPAISSEUR

- ES**
1. CARACTERÍSTICAS
  2. COMPOSICIÓN
  3. PESO
  4. REACCIÓN AL FUEGO
  5. ABRASIÓN
  6. ESPESOR

## AVVERTENZA NOTICE

I campioni illustrati in questo catalogo corrispondono agli originali. Eventuali differenze di colore sono dovute a motivi tecnici di stampa.

- EN** The sample colours pictured in this catalogue are representations of the originals. There could be slight colour differences due to the printing technique.
- FR** Le reproduction photographique des échantillons de tissus et cuir de cette catalogue a été réalisée d'après des originaux. Toute différence de teinte éventuelle est à imputer au procédé d'impression.
- ES** Las muestras impresas en este catalogo son copia de los originales. Las ligeras variaciones que puedan existir son debidas a la impresión.

## CURA E MANUTENZIONE CARE AND MAINTENANCE



**Usare con regolarità l'aspirapolvere a beccuccio liscio.**

- EN** Use the vacuum cleaner with smooth spout regularly.
- FR** Utiliser régulièrement un aspirateur avec un embout souple.
- ES** Utilizar con regularidad una aspiradora con boquilla suave.



**Pulire con un panno umido, sciacquare con acqua ed asciugare accuratamente. Usare solo detergente neutro diluito in acqua.**

- EN** Clean with a damp cloth, rinse with water and dry thoroughly. Use only mild detergent diluted in water.
- FR** Nettoyer avec un chiffon humide, rincer à l'eau et sécher parfaitement. Utiliser seulement un détergent doux dilué dans l'eau.
- ES** Limpiar con un paño húmedo, aclarar con agua y secar minuciosamente. Utilizar solamente detergente suave diluido en agua.



**Pulire con un panno morbido asciutto.**

- EN** Clean regularly with dry soft cloth.
- FR** Nettoyer avec un chiffon doux et sec.
- ES** Limpiar con un paño suave seco.



**In caso di macchie utilizzare uno smacchiatore spray per tessuti.**

- EN** In the event stains use a stain remover spray for textile.
- FR** En cas de taches, utiliser un spray détachant pour textile.
- ES** Para eliminar manchas, utilizar un quitamanchas textil en spray.



**In caso di macchie utilizzare uno smacchiatore per pelli.**

- EN** In case of spots use a spot removal for leathers.
- FR** En cas de taches, utiliser un spray détachant pour cuir.
- ES** Para eliminar manchas, utilizar un quitamanchas para pelli.



**Non usare sbiancanti al cloro.**

- EN** Do not use chlorine bleach.
- FR** Ne pas utiliser d'eau de Javel.
- ES** No utilizar blanqueadores o lejía.



**Non spazzolare.**

- EN** Do not brush.
- FR** Ne pas brosser.
- ES** No cepillar.

# PELLI E TESSUTI FABRICS AND LEATHERS

## AG GUATEMALA

1. SIMILPELLE / VINYL
2. 88% PVC - 8% POLIESTERE - 4% COTONE  
88% PVC - 8% POLYESTER - 4% COTTON
3. 910 GR./MTL / 910 GR./LM
4. CLASSE 1 (UNI 9175)  
CLASS 1 (UNI 9175)
5. 100.000 CICLI (UNI EN ISO 12947)  
100.000 TURNS (UNI EN ISO 12947)

PRODOTTO PRIVO DI FTALATI / PHTHALATE FREE

### CURA E MANUTENZIONE CARE AND MAINTENANCE

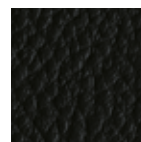

13AG22



13AG46



13AG27



13AG98

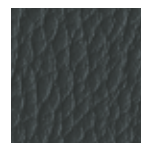

13AG21



13AG26



13AG07



13AG48

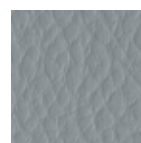

13AG31



13AG05



13AG20



13AG28



13AG71



13AG45



13AG30

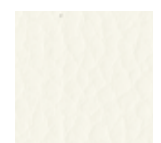

13AG00

# AL LEIRIA

1. CREP / CREPE
2. 100% POLIESTERE / 100% POLYESTER
3. 350 GR./MTL / 350 GR./LM
4. CLASSE 1 (UNI 9175) EN 1021 (PARTI 1-2)  
CLASS 1 (UNI 9175) EN 1021 (PART 1-2)
5. 150.000 CICLI (UNI EN ISO 12947)  
150.000 TURNS (UNI EN ISO 12947)

## CURA E MANUTENZIONE CARE AND MAINTENANCE

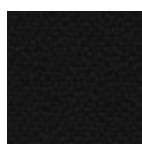

13AL02



13AL26



13AL07



13AL25



13AL12



13AL06



13AL20



13AL05



13AL21



13AL03

# AR RADIO

1. TELA / CANVAS
2. 100% POLIESTERE FR / 100% POLYESTER FR
3. 450 GR./MTL / 450 GR./LM
4. EN 1021 (PARTI 1-2)  
EN 1021 (PART 1-2)
5. 100.000 CICLI (UNI EN ISO 12947)  
100.000 TURNS (UNI EN ISO 12947)

## CURA E MANUTENZIONE CARE AND MAINTENANCE

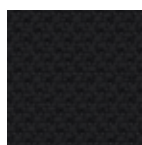

13AR02



13AR36

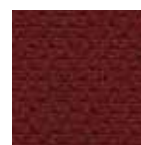

13AR34



13AR35



13AR52



13AR26



13AR17



13AR45



13AR13



13AR16

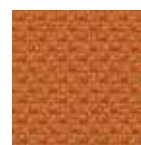

13AR40



13AR25

## PELLI E TESSUTI FABRICS AND LEATHERS

### BB BELEM

1. TESSUTO ANTIBATTERICO / ANTIBACTERIAL FABRIC
2. 100% POLIESTERE TREVIRA CS / 100% POLYESTER TREVIRA CS
3. 490 GR./MTL / 490 GR./LM
4. CLASSE 1 (UNI 9175)  
CLASS 1 (UNI 9175)
5. 100.000 CICLI (UNI EN ISO 12947)  
100.000 TURNS (UNI EN ISO 12947)

#### CURA E MANUTENZIONE CARE AND MAINTENANCE



13BB02



13BB26



13BB07



13BB35



13BB31

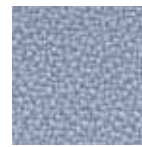

13BB56



13BB20



13BB75



13BB12

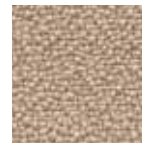

13BB03



13BB30



13BB15

### BL LAGOS

1. TESSUTO A INTRECCI / VEAVES FABRIC
2. 100% POLIESTERE FR RICICLATO  
100% POLYESTER FR RECYCLED
3. 470 GR./MTL / 470 GR./LM
4. CLASSE 1 (UNI 9175) EN 1021 (PARTI 1-2)  
CLASS 1 (UNI 9175) EN 1021 (PART 1-2)
5. 50.000 CICLI (UNI EN ISO 12947)  
50.000 TURNS (UNI EN ISO 12947)

#### CURA E MANUTENZIONE CARE AND MAINTENANCE



13BL02



13BL26



13BL34

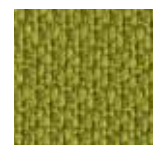

13BL05



13BL21



13BL16



13BL07

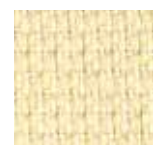

13BL10



# BR RIO

1. SIMILPELLE ANTIBATTERICA / VINYL ANTIBACTERIAL TREATMENT
2. 91% PVC - 9% POLIAMMIDE  
91% PVC - 9% POLYAMIDE
3. 994 GR./MTL / 994 GR./LM
4. CLASSE 1 (UNI 9175)  
CLASS 1 (UNI 9175)
5. UNI 4818 15 (METODO A)  
UNI 4818 15 (METHOD A)

PRODOTTO PRIVO DI FTALATI / PHTHALATE FREE

## CURA E MANUTENZIONE CARE AND MAINTENANCE



13BR02



13BR06

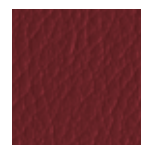

13BR34



13BR10

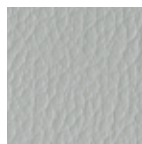

13BR21



13BR16



13BR07

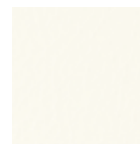

13BR00

# CE ERA

1. TELA / CANVAS
2. 100% POLIESTERE  
100% POLYESTER
3. 490 GR./MTL / 490 GR./LM
4. EN 1021 (PARTI 1-2)  
EN 1021 (PART 1-2)
5. 10.000 CICLI (UNI EN ISO 12947)  
100.000 TURNS (UNI EN ISO 12947)

## CURA E MANUTENZIONE CARE AND MAINTENANCE

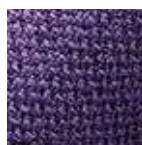
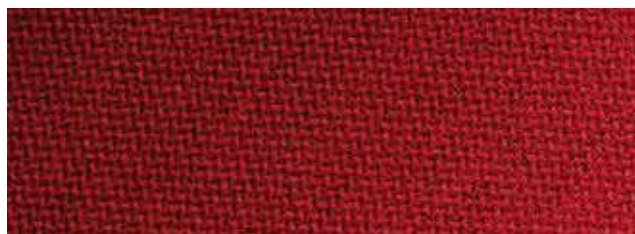

13CE19

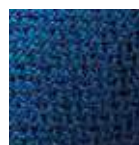

13CE06

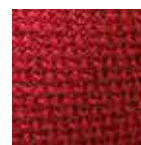

13CE07

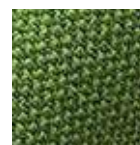

13CE15



13CE12



13CE16

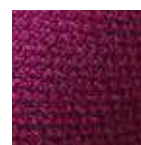

13CE09



13CE30

## PELLI E TESSUTI FABRICS AND LEATHERS

### CT TREVI

1. TELA. CANVAS
2. 100% POLIESTERE TREVIRA CS  
100% POLYESTER TREVIRA CS
3. 630 GR./MTL / 630 GR./LM
4. CLASSE 1 (UNI 9175) EN 1021 (PARTI 1-2)  
CLASS 1 (UNI 9175) EN 1021 (PART 1-2)
5. 100.000 CICLI (UNI EN ISO 12947)  
100.000 TURNS (UNI EN ISO 12947)

#### CURA E MANUTENZIONE CARE AND MAINTENANCE



13CT02

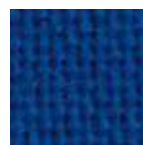

13CT16



13CT47



13CT32



13CT03



13CT07

### CR MERIDA IGNIFUGO

1. SIMILPELLE TRASPIRANTE / BREATHABLE VINYL
2. 41% POLIURETANO - 18% POLIESTERE - 41% COTONE  
41% POLYURETHANE - 18% POLYESTER - 41% COTTON
3. 560 GR./MTL / 560 GR./LM
4. CLASSE 1 (UNI 9175)  
CLASS 1 (UNI 9175)
5. 100.000 CICLI (UNI EN ISO 12947)  
100.000 TURNS (UNI EN ISO 12947)

PRODOTTO PRIVO DI FTALATI / PHTHALATE FREE

#### CURA E MANUTENZIONE CARE AND MAINTENANCE

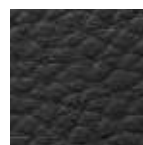

13CR32



13CR44

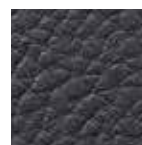

13CR53



13CR52



13CR66

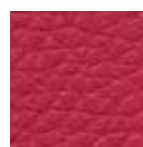

13CR67



13CR11

# DB BOGOTÀ

1. LANA / WOOL
2. 100% LANA  
100% WOOL
3. 825 GR./MTL / 825 GR./LM
4. EN 1021 (PARTI 1-2)  
EN 1021 (PART 1-2)
5. 60.000 CICLI (UNI EN ISO 12947)  
60.000 TURNS (UNI EN ISO 12947)

## CURA E MANUTENZIONE CARE AND MAINTENANCE



13DB02



13DB06



13DB04



13DB05



13DB12



13DB09



13DB30



13DB15

# ET STEELCUT TRIO 3

by KVADRAT

1. LANA / WOOL
2. 90% LANA - 10% NYLON  
90% WOOL - 10% NYLON
3. 770 GR./MTL / 770 GR./LM
4. CLASSE 1 (UNI 9175) EN 1021 (PARTI 1-2)  
CLASS 1 (UNI 9175) EN 1021 (PART 1- 2)
5. 100.000 CICLI (UNI EN ISO 12947)  
100.000 TURNS (UNI EN ISO 12947)

## CURA E MANUTENZIONE CARE AND MAINTENANCE

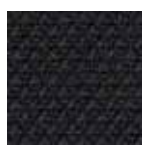

13ET02

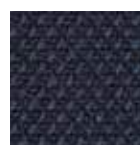

13ET36



13ET07



13ET35

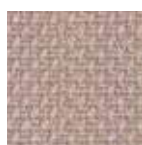

13ET08



13ET03

## PELLI E TESSUTI FABRICS AND LEATHERS

# EP PELLE NATURALE

1. VERA PELLE BOVINA, CONCIATA AL CROMO, TINTA IN BOTTE ALL'ANILINA, SMERIGLIATA E RIFINITA CON RESINE POLIURETANICHE / OX HIDES, CHROME TANNAGE, ANILINE-DYED, BUFFED AND FINISHED WITH POLYURETHANE RESINS.
6. 0.9 / 1.0 MM.

AVVERTENZA: LE IRREGOLARITÀ NATURALI DELLA PELLE, PUNTURE D'INSETTI, PICCOLE CICATRICI E VARIAZIONI DI COLORE CONFERMANO L'AUTENTICITÀ DEL MATERIALE, PERTANTO NON SONO MOTIVO DI RECLAMO.  
NOTICE: NATURAL FEATURES SUCH AS INSECT BITES, SMALL DEFORMITIES AND COLOR SHADING CONFIRM THE LEATHER'S AUTHENTIC CHARACTER AND ARE NOT GROUNDS FOR COMPLAINT.

### CURA E MANUTENZIONE CARE AND MAINTENANCE



13EP02



13EP06

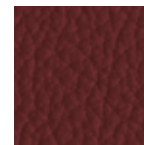

13EP34

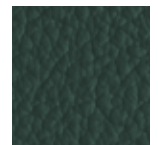

13EP05



13EP11

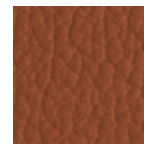

13EP17



13EP07



13EP10



13EP23



13EP00

# FP PELLE EXTRA

1. VERA PELLE BOVINA FIORE, CONCIATA AL CROMO, TINTA IN BOTTE ALL'ANILINA, GRANA NATURALE / OX HIDES, CHROME TANNAGE, ANILINE-DYED, NATURAL GRAIN.
6. 1.3 / 1.5 MM

AVVERTENZA: LE IRREGOLARITÀ NATURALI DELLA PELLE, PUNTURE D'INSETTI, PICCOLE CICATRICI E VARIAZIONI DI COLORE CONFERMANO L'AUTENTICITÀ DEL MATERIALE, PERTANTO NON SONO MOTIVO DI RECLAMO.  
NOTICE: NATURAL FEATURES SUCH AS INSECT BITES, SMALL DEFORMITIES AND COLOR SHADING CONFIRM THE LEATHER'S AUTHENTIC CHARACTER AND ARE NOT GROUNDS FOR COMPLAINT.

### CURA E MANUTENZIONE CARE AND MAINTENANCE



13FP32



13FP06



13FP04



13FP05



13FP11



13FP03



13FP07



13FP28



13FP12



13FP10

# AG/EP PELLE E SIMILPELLE

1. RIVESTIMENTO COMBINATO PELLE CAT. EP E SIMILPELLE CAT. AG  
COMBINATION UPHOLSTERY LEATHER, CAT. EP AND VINYL CAT. AG

DISPONIBILE PER AQABA.  
AVAILABLE FOR AQABA.

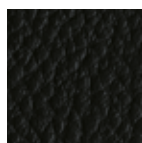

02 NERO

# RE RETE

1. TESSUTO TECNICO / TECHNICAL FABRIC
2. 100% POLIESTERE  
100% POLYESTER
3. 430 GR./MTL / 430 GR./LM
4. CLASSE 1 (UNI 9175) SOLO PER CODICE 13R1IM  
CLASS 1 (UNI 9175) ONLY FOR CODE 13R1IM
5. 100.000 CICLI (UNI EN ISO 12947)  
100.000 TURNS (UNI EN ISO 12947)

DISPONIBILE PER EXPO, EXPO LIGHT, BURSA RETE EVOLUTION,  
101 RETE, LINEA R E ASSIA.

AVAILABLE FOR EXPO, EXPO LIGHT, BURSA RETE EVOLUTION,  
101 RETE, LINEA R AND ASSIA.

## CURA E MANUTENZIONE CARE AND MAINTENANCE

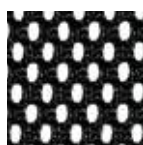
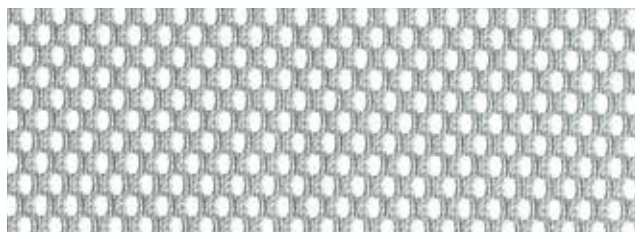

13RETE - 13R1IM

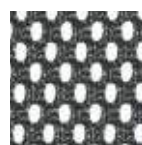

13RE\_P

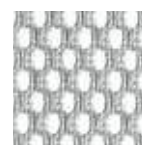

13RE\_G



13RE\_B



13RE\_M



13RE\_R



13RE\_W

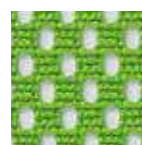

13RETV

# PELLI E TESSUTI FABRICS AND LEATHERS

## RS RETE

1. TESSUTO TECNICO / TECHNICAL FABRIC
2. 97% POLIESTERE - 2% POLIAMMIDE - 1% ELASTANE  
97% POLYESTER - 2% POLYAMIDE - 1% ELASTHAN
3. 370 GR./MTL / 370 GR./LM
4. UNI 1021 (PARTE 1)  
UNI 1021 (PART 1)
5. 30.000 CICLI (UNI EN ISO 12947)  
30.000 TURNS (UNI EN ISO 12947)

DISPONIBILE PER EXPO E EXPO LIGHT.  
AVAILABLE FOR EXPO AND EXPO LIGHT.

### CURA E MANUTENZIONE CARE AND MAINTENANCE

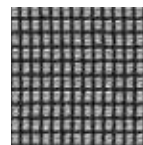
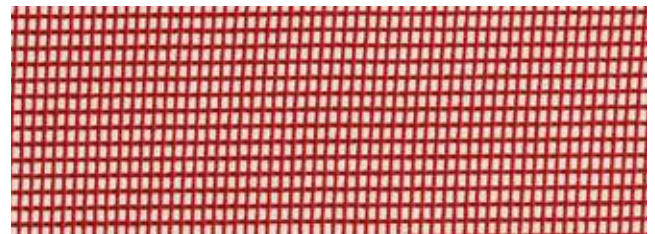

13RS02

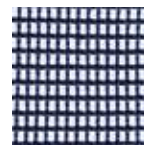

13RS06

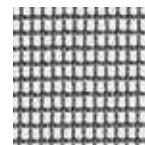

13RS21



13RS00

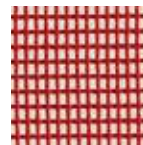

13RS07

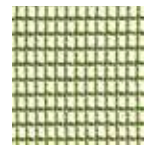

13RS05

## RP RETE

1. TESSUTO TECNICO / TECHNICAL FABRIC
2. 97% POLIESTERE - 2% POLIAMMIDE - 1% ELASTANE  
97% POLYESTER - 2% POLYAMIDE - 1% ELASTHAN
3. 370 GR./MTL / 370 GR./LM
4. UNI 1021 (PARTE 1)  
UNI 1021 (PART 1)
5. 30.000 CICLI (UNI EN ISO 12947)  
30.000 TURNS (UNI EN ISO 12947)

DISPONIBILE PER YALTA.  
AVAILABLE FOR YALTA.

### CURA E MANUTENZIONE CARE AND MAINTENANCE

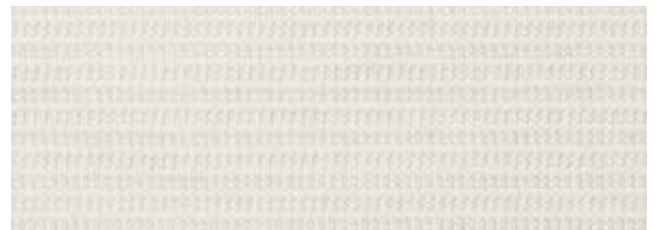

13RP02



13RP10

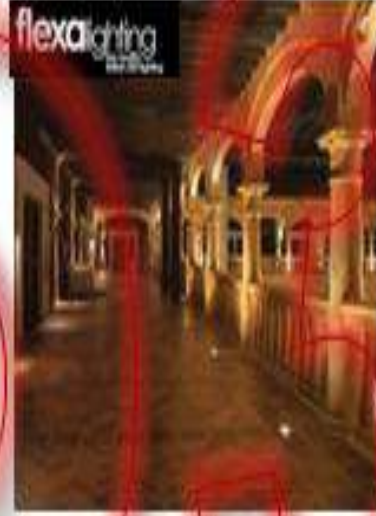



Perpetual

Project

Planning

*Thank you*

We welcome your questions and queries.

Contact us on: +91 98202 54444

Email: [info@pcubesolutions.com](mailto:info@pcubesolutions.com)

Website: [www.pcubesolutions.com](http://www.pcubesolutions.com)